

Variable Descriptions of the A-Train Integrated CALIPSO, CloudSat, CERES, and MODIS Merged Product (CCCM or C3M)

Seiji Kato¹
Seung-Hee Ham²
Walter F. Miller²
Sunny Sun-Mack²
Fred G. Rose²
Yan Chen²
Pamela E. Mlynchak²

¹ NASA Langley Research Center, Hampton, Virginia U.S.A.

² Science Systems & Applications, Inc. Hampton, Virginia U.S.A.

Document Version: RelD1
Last updated: November 2021

TABLE OF CONTENTS

<u>Section</u>	<u>Page</u>
1.0 CCCM Overview	1
2.0 CCCM Variable Descriptions	7
2.1 CALIPSO and MODIS Surface Map Along Ground Track	7
2.2 Cloud and Aerosol Mask (CALIPSO and CloudSat).....	8
2.3 MODIS Properties over CALIPSO and CloudSat Groups.....	13
2.4 CALIPSO Aerosol Layer Mean	15
2.5 Cloud Layer Mean.....	19
2.6 Vertical Model Input Profile	26
2.6.1 Cloud Data Sources for Irradiance Computations	26
2.6.2 Aerosol Data Sources for Irradiance Computations	28
2.6.3 Temperature and Humidity Profiles for Irradiance Computations	29
2.7 Vertical Irradiance Profile.....	31
2.8 Vertical Height Profile	36
3.0 SSF Variable Descriptions.....	38
3.1 Scene Type Definitions	38
3.2 CERES-derived TOA and Surface Irradiances (Vgroup: TOA and Surface Fluxes)	40
3.3 Full Footprint Area Definitions.....	41
3.4 Clear Footprint Area Definitions.....	44
3.5 Cloudy Footprint Area Definitions	44
3.6 Multilayer Cloud Footprint Area Definitions.....	46
3.7 Additional Footprint Imager Radiance Statistics Definitions	56
3.8 MODIS Ocean Aerosols Definitions.....	57
4.0 CRS Variable Descriptions	58
5.0 References.....	59

LIST OF FIGURES

<u>Figure</u>	<u>Page</u>
Figure 1-1. Schematic of the cloud grouping process. Cloud profiles that occur within a CERES footprint and have the same cloud boundary heights are grouped together. Group number of 1 is assigned to the cloud group having the largest cloud fraction over a CERES footprint.	4
Figure 1-2. Hypothetical clouds over the CALIPSO and CloudSat ground track in a CERES footprint that have been sorted into cloud groups. Cloud layers in a cloud group are stored from the higher to lower altitudes as shown by the number on each cloud layer in this figure.	5
Figure 3-1. Cloud classification.	38
Figure 3-2. Additional notes on cloud algorithms.	42
Figure 3-3. Notes on cloud multilayer.	43
Figure 3-4. Illustration of the CERES single layer/multilayer cloud coverage classification. (1) single lower layer, (2) single upper layer, (3) lower multilayer, and (4) upper multilayer in Ed4 SSF. Note that if the revised cloud algorithm were used, the sum of (1) and (3) would be classified as a lower layer and the sum of (2) and (4) would be classified as an upper layer because cloud overlap is not treated in the revised algorithm. Clouds classified as (3) would belong to (1) if the revised algorithm were applied. Similarly clouds classified as (4) would belong to (2).	48
Figure 3-5. Illustration of the CERES single layer/multilayer cloud coverage classification in Ed4 SSF, but when the revised cloud algorithm had only one layer. The single layer/multilayer cloud coverage will be reported in (1) single lower layer and (3) lower multilayer. Since there was not an upper cloud in the revised algorithm, (2) single upper layer and (4) upper multilayer coverages are not present and are set to zero. In the revised algorithm, the sum of (1) and (3) would be classified as a lower layer because cloud overlap is not treated. Clouds classified as (3) would belong to (1) if the revised algorithm were applied. The revised cloud algorithm reports only one cloud layer within a footprint; therefore, a cloud layer property will be assigned to single lower layer (1). Cloud layer properties for the single upper layer (2) would be set to default because there are no upper layer pixels from the revised cloud algorithm. Since some of the pixels from the lower layer of the revised cloud algorithm are actually multilayer, both (3) and (4) will have cloud layer properties assigned.	50

LIST OF TABLES

<u>Table</u>	<u>Page</u>
Table 1-1. Algorithms Used and Sources of Retrieved Variables Included in CCCM	2
Table 1-2. Sets of MODIS-derived Cloud Properties in the CCCM Product.....	2
Table 1-3. Cloud Top and Base Merging Strategy (Kato et al. 2010).....	3
Table 3-1. Surface Code Definition.....	39
Table 3-2. Cloud Layer Code Definition.....	39

1.0 CCCM Overview

The A-Train Integrated CALIPSO, CloudSat, CERES, and MODIS Merged product (CCCM) contains data from various satellites and instruments with different spatial resolutions. To overcome different fields of view by multiple sensors, observations are collocated with a two-step process. Three 333-m resolution CALIPSO profiles and one CloudSat profile (1.4 km × 1.9 km resolution) are collocated with each 1-km MODIS imager pixel using geolocation information (latitude and longitude). These 1-km data are then collocated with 20-km CERES near-nadir footprints that overlap the CALIPSO and CloudSat ground track. The CERES footprint is a common grid in which all data are stored in this product. When mean and standard deviation over a CERES footprint are computed, the CERES point spread function (PSF) is used to convolve the higher resolution data into the CERES 20-km optical footprint. The size of the CERES point spread function is 35 km, which covers 95% of the energy detected by the CERES instrument (Aqua-FM3). Only the CERES footprint that has the maximum overlap with the CALIPSO and CloudSat ground track for each scan of the CERES instrument is included in this product. For each of these near-nadir footprints, the CCCM product also contains CERES-derived top-of-atmosphere (TOA) irradiances and vertical profiles of shortwave (SW), longwave (LW), and window (WN) modeled irradiances. The product is available in daily files.

The CCCM product combines variables from standard CERES data products (the Single Scanner Footprint (SSF) Edition5-Beta1 product and the Clouds and Radiative Swath (CRS) Edition5 beta product) and introduces new variables unique to this product (CCCM). The order of variables kept in the product is SSF, CRS, and then CCCM variables. Because of the integration of multiple instruments, variables derived from multiple algorithms/instruments are included in the product. The algorithm/instruments are roughly divided into three categories, explained here and summarized in [Table 1-1](#).

Cloud and aerosol properties derived from MODIS only by the algorithm that is similar to the CERES cloud algorithms (Edition 5-Beta1). The data structure of this portion of the product follows exactly the same format of the CERES SSF. Therefore, cloud properties for up to 2 non-overlapping clouds for the entire CERES footprint are included (except for the multilayer cloud variables from SSF-114a through SSF-114k). The irradiances are computed for 5 atmospheric levels including TOA and the surface, such as done in the CERES CRS product. CRS variables are stored after the SSF variables. Descriptions of SSF and CRS variables can be found from <http://ceres.larc.nasa.gov/docs.php> or from the SSF collection guide (http://ceres.larc.nasa.gov/collect_guide.php).

Cloud and aerosol properties derived from the enhanced CERES cloud algorithm. The enhanced algorithm uses cloud mask and height derived from CALIPSO and CloudSat to improve the accuracy of the cloud property retrieval (Kato et al. 2011).

The vertical profile of cloud and aerosol properties derived from CALIPSO and CloudSat. The retrieval is limited to the area over the ground track of CALIPSO and CloudSat. Therefore, profiles cover only a small part of a CERES footprint. The vertical resolution of the retrieved cloud and aerosol properties closely follows the original CALIPSO and CloudSat data.

Table 1-1. Algorithms Used and Sources of Retrieved Variables Included in CCCM

Type	Instrument	Derived Properties	Description
1	MODIS	Column integrated cloud properties	CERES cloud algorithm Edition5-Beta1
2	MODIS, CALIPSO	Column integrated cloud properties	Enhanced cloud algorithm--Adjust MODIS cloud top height according to CALIPSO
3	CALIPSO, CloudSat	Vertical profile of cloud and aerosol properties	Extracted from CALIPSO (VFM, 5 km cloud layer and profile, 5 km aerosol layer) and CloudSat (CLDCLASS and CWC-RO) products.

Unlike the standard SSF and CRS data products that use one set of MODIS-derived cloud properties for each CERES footprint, the CCCM product contains four different sets of MODIS-derived cloud properties that are explained here and summarized in [Table 1-2](#):

1. Full MODIS pixel coverage over a CERES footprint and cloud properties derived from the CERES Edition 5-Beta 1 cloud algorithm (standard cloud algorithm). This set is included in the standard CERES SSF format and used for irradiance computations in the CRS.
2. MODIS pixels selected only over the CALIPSO and CloudSat ground track and cloud properties derived from the standard cloud algorithm.
3. MODIS pixels selected only over the CALIPSO and CloudSat ground track and cloud properties derived from the CERES cloud algorithm run with CALIPSO and CloudSat-derived cloud height as input to the algorithm, improving the cloud properties derived from the MODIS data (enhanced cloud algorithm).
4. Full MODIS pixel coverage over a CERES footprint and cloud properties derived from the enhanced cloud algorithm. This fourth set is under development and currently contains a default value only.

Table 1-2. Sets of MODIS-derived Cloud Properties in the CCCM Product

Set	Name	Cloud Algorithm	Cloud Mask	MODIS Pixel Coverage
1	Full	Standard	MODIS	Full CERES footprint
2	Track	Standard	MODIS	Along CALIPSO/CloudSat track only
3	Enhance Track	Enhanced	MODIS	Along CALIPSO/CloudSat track only
4	Enhance Full	Enhanced	MODIS	Full CERES footprint

Variables in the SSF portion of the CCCM product contain the footprint geolocation information, CERES observed radiances and fluxes, and MODIS-derived cloud and aerosol properties. The variables in the SSF portion use the same names as the standard SSF variables. Many of these variables have the same dimensions as in the standard SSF product, but others now contain an extra dimension for full and track footprints or for the four sets of MODIS-derived cloud properties. The CRS portion of the CCCM product contains radiative fluxes computed with the first set of MODIS-derived cloud properties. The CRS variables are exactly like the standard CRS variables in both name and dimension. The CALIPSO and CloudSat-derived cloud and aerosol properties and irradiance profiles computed with them are included following the SSF and CRS portions.

Descriptions of CALIPSO and CloudSat cloud and aerosol properties

CALIPSO and CloudSat masks are sorted into 1 km horizontal bins (1 km pixels). The vertical resolution of the cloud mask is the same as the CALIPSO vertical feature mask resolution, 30 m below 8.2 km and 60 m above 8.2 km. [Table 1-3](#) describes the cloud merging strategy of the CALIPSO and CloudSat cloud heights and is briefly explained below.

When either CALIPSO or CloudSat detects a cloud layer:

The cloud layer is kept.

When both CALIPSO and CloudSat detect a cloud layer:

Cloud top height comes from either CALIPSO or CloudSat, whichever reports a higher cloud top height. Unless the CloudSat height is less than 480 m from the CALIPSO-derived height, then CALIPSO is used. When the CloudSat height is more than 480 m from the closest CALIPSO height, the CloudSat cloud is inverted into the CALIPSO cloud vertical profile. Cloud base height comes from CALIPSO when the CALIPSO signal is not attenuated.

When the CALIPSO signal is completely attenuated:

Cloud base height comes from CloudSat if CloudSat detects the cloud below the complete attenuation level. If CloudSat misses the cloud, the top of the attenuation layer is used for the cloud base height.

Table 1-3. Cloud Top and Base Merging Strategy (Kato et al. 2010)

Cloud boundary	CALIPSO	CloudSat	Merged Cloud boundary
Top	Detected	Detected	Higher cloud top
Top	Detected	Undetected	CALIPSO cloud top
Top	Undetected	Detected	CloudSat cloud top
Base	Not completely attenuated	Undetected	CALIPSO cloud base
Base	Not completely attenuated	Detected	CALIPSO cloud base
Base	Totally attenuated	Detected	CloudSat cloud base
Base	Totally attenuated	Undetected	CALIPSO lowest unattenuated base

When CloudSat detects cloud layers that are separated by a clear-sky layer with depth less than 480 m within a CALIPSO cloud layer, the CloudSat-detected cloud layers are considered to be the same cloud as the CALIPSO-detected cloud layers. Cloud profiles are further sorted horizontally. Profiles that have the same vertical cloud structure (cloud top and base height, as well as number of overlapping cloud layers) are grouped together, as shown in Figure 1-1. After the grouping process, the cloud fraction of each cloud group along the ground track of CALIPSO and CloudSat is computed.

The product keeps up to 16 cloud groups (i.e., 16 different sets of cloud boundaries) in a CERES footprint. For each cloud group, there are up to 6 separate cloud overlapping layers. The cloud group that has the largest PSF-weighted coverage within a CERES footprint is reported first in the file.

The height of one aerosol layer derived from CALIPSO and overlapping each cloud group is kept in the product. For cloud-free areas in a CERES footprint that are identified by CALIPSO and CloudSat, up to 16 aerosol layers detected by CALIPSO are kept.

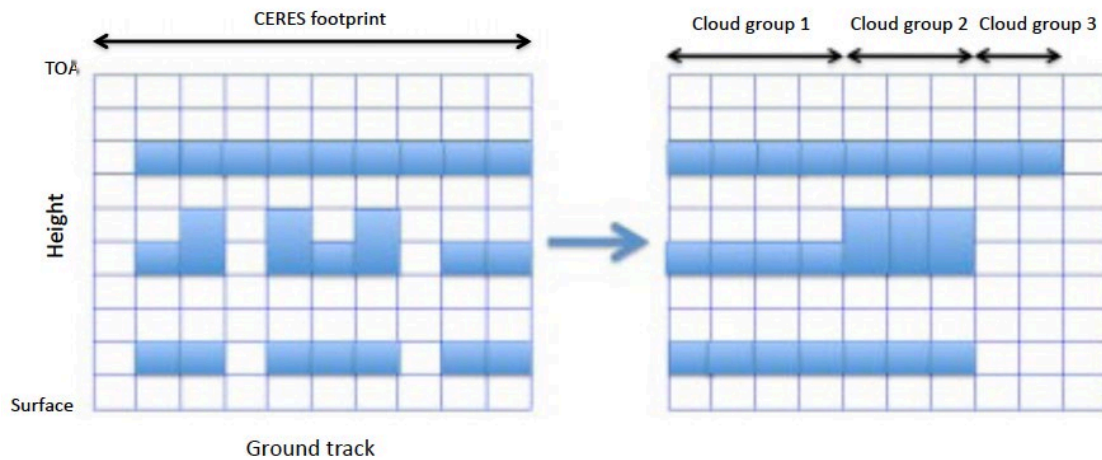

Figure 1-1. Schematic of the cloud grouping process. Cloud profiles that occur within a CERES footprint and have the same cloud boundary heights are grouped together. Group number of 1 is assigned to the cloud group having the largest cloud fraction over a CERES footprint.

Example case (shown in Figure 1-2):

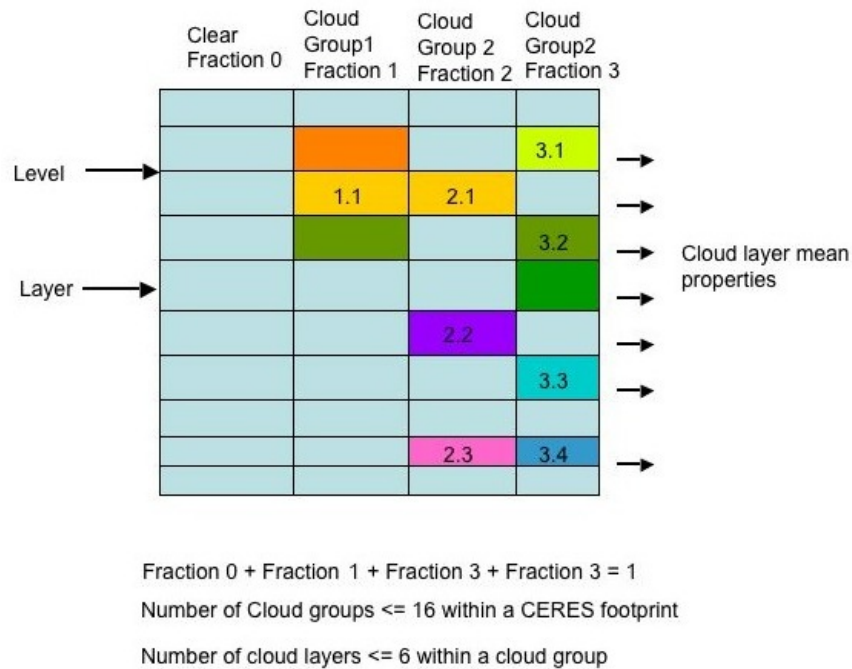

Figure 1-2. Hypothetical clouds over the CALIPSO and CloudSat ground track in a CERES footprint that have been sorted into cloud groups. Cloud layers in a cloud group are stored from the higher to lower altitudes as shown by the number on each cloud layer in this figure.

Figure 1-2 shows hypothetical cloud layers over the ground track of CALIPSO and CloudSat in a CERES footprint after the sorting process shown in Figure 1-1 is applied.

- The leftmost column: Clear fraction of 40%
- Second from the leftmost column: one-layer cloud (cloud fraction = 30%)
- Third from the leftmost column: three-layer clouds (cloud fraction = 20%)
- Fourth from the leftmost column: four-layer clouds (cloud fraction = 10%)

The number of cloud groups m (cloud overlap combinations) for this case is 3 (i.e. m= 3). The number of overlapping layers p for the first, second and third cloud groups are 1, 3, and 4, respectively.

Irradiance computations

Irradiances in the CCCM product are computed using various sources. Cloud and aerosol optical properties used in the computations are chosen first from active sensor derived properties followed by properties derived from the enhanced cloud algorithm. Detailed descriptions of how these properties are used in the irradiance computations are given in Kato et al. (2011) but the method is briefly explained below.

In order to compute irradiances for cloudy sky, the following cloud properties must be present for each cloud group layer: cloud top pressure, cloud base pressure, water phase, particle size, and either (liquid or ice) water path or optical depth.

In addition to CRS computations that only use MODIS-derived cloud properties in the CERES process, two sets of irradiance calculations are made over the track of CALIPSO/CloudSat within the CERES footprint. For these two sets of computations, MODIS-derived cloud properties come from different algorithms: 1) the standard Ed2 standard cloud algorithm and 2) the enhanced algorithm. In both cases we combine cloud information from MODIS (optical depth, phase and particle size) with the CALIPSO/CloudSat vertical profiles. Therefore in both cases the CALIPSO/CloudSat vertical structure of up to 16 cloud groups with up to 6 overlapping cloud layers is used.

Because the CALIPSO/CloudSat cloud mask is not necessarily consistent with the MODIS cloud mask, there are frequently cases where cloud groups miss MODIS-derived cloud properties. Since we strive to use MODIS-determined cloud optical depth as a constraint on the vertically integrated CALIPSO and CloudSat profiles for each cloud group (Kato et. al. 2011), we adjust the area coverage of cloud groups that have valid MODIS cloud properties to equal the total cloud area as determined by CALIPSO and Cloudsat. If no valid MODIS cloud properties are associated with all cloud groups detected by CALIPSO and CloudSat within a CERES footprint, the CALIPSO or CloudSat-determined cloud optical depths are then used for the irradiance computations for all cloud groups within a CERES footprint.

Below is the description of variables included in CCCM. The unique CCCM variables (mostly extracted from CALIPSO and CloudSat products) are listed first in Section 2.0. Descriptions of the SSF variables included in the CCCM product that are new to Edition5-Beta1 (i.e. not in Ed2 SSF) are included in Section 3.0. Information on the CRS variables can be found in Section 4.0.

2.0 CCCM Variable Descriptions

Variables in this list are first noted by their variable number and then by the variable name as found in the HDF file. For convenience when searching for a particular variable, the variables are divided into subsections that correspond to the Vgroup names in the CCCM HDF file.

2.1 CALIPSO and MODIS Surface Map Along Ground Track

These variables describe the Earth's surface conditions for each CERES footprint.

CCCM-1 Mean altitude of surface above sea level

Mean surface altitude from CALIPSO VFM over a CERES footprint. Default value occurs when there are no good CALIPSO profiles within a CERES footprint or when all CALIPSO signals are completely attenuated.

CCCM-2 Stdev of altitude of surface above sea level

Standard deviation of surface altitudes from CALIPSO VFM over a CERES footprint.

CCCM-3 Surface spectral albedo

Surface spectral clear-sky albedo at 7 wavelengths derived from MODIS narrowband measurements. The 7 wavelength ranges are:

- 1) 620 - 670nm
- 2) 841 - 876nm
- 3) 459 - 479nm
- 4) 545 - 565nm
- 5) 1230 - 1250nm
- 6) 1628 - 1652nm
- 7) 2105 - 2155nm

Over ocean, empirical ocean surface albedo model is used (Zin et al. 2004), which is a function of cosine of solar zenith angle, wind speed, and chlorophyll concentration. The land surface albedo is described from MODIS if the albedo is available from MODIS or a composite file created from a full season of MODIS files. The composite file is used for areas where the cloud cover is large. The clear-sky spectral albedo is derived from a MODIS-supplied look-up-table that is a function of solar zenith angle and aerosol optical thickness and that is derived by a combination of the black (direct) and white (diffuse) sky albedos. Over snow/ice surface albedo, monthly surface albedo history (SAH) map is used.

If MODIS albedo is not available over land, or SAH map is not available for snow/ice, a surface albedo is assigned from climatological values for the given IGBP scene identification, cosine of solar zenith angle, and precipitable water.

The spectral albedo(s) can also be obtained indirectly from the ratio of spectral up and down total-sky surface fluxes (CCCM-105 and 106).

This brief description of the MODIS albedo product was obtained from the [MODIS User Guide V006](#):

The MCD43C1 Climate Modeling Grid (CMG) BRDF/Albedo Model Parameters Product (MODIS/Terra & Aqua BRDF/Albedo Parameters Daily L3 Global 0.05Deg CMG) supplies the weighting parameters associated with the RossThickLiSparseReciprocal BRDF model that best describes the anisotropy of each pixel. These three parameters (*fiso*, *fvol*, *fgeo*) are provided for each of the MODIS spectral bands as well as for three broad bands (0.3-0.7 μ m, 0.7-5.0 μ m, and 0.3-5.0 μ m) at a 0.05 degree spatial resolution in global files in a geographic (lat/lon) projection. These model parameters are based on the underlying 30arcsecond model parameters. Note that along coastlines, this means that the 30arcsecond pixels that lie over shallow water will be averaged into the 0.05 degree CMG pixel. In addition to the spectral and broadband parameters themselves, the MCD43C1 CMG BRDF/Albedo Model Parameters Product also provides extensive quality information. The quality and inversion status of the majority of the underlying 30arcsecond pixels is provided as well as the percentage of the underlying pixels that were present or were snow covered. The uncertainty layer gives the quality of the full inversion from the measure of the angular sampling of input surface reflectance for the BRDF retrieval.

CCCM-4 Mean CloudSat surface reflectivity

Not currently filled. Values are set to zero.

CCCM-5 Stdev CloudSat surface reflectivity

Not currently filled. Values are set to zero.

2.2 Cloud and Aerosol Mask (CALIPSO and CloudSat)

CALIPSO and CloudSat-derived properties are kept closely following the original vertical and horizontal resolution as much as possible. After reviewing statistics of the number of unique cloud groups within a footprint and cloud layers in the profile, the maximum number of groups within a CERES footprint is 16, and the maximum number of layers within a group is 6 (Kato et al. 2010). For the few cases where the number of unique groups exceeds 16, a process was adopted to combine profiles with nearly the same cloud top and base heights.

The CALIPSO and CloudSat cloud masks, obtained from the CALIPSO Lidar Level 2 Vertical Feature Mask (VFM) product and the CloudSat 2B-CLDCLASS product, are independent and sometimes can differ significantly due to the sensitivity difference of lidar and radar to hydrometeors. This results in three cases, or combinations, when the CALIPSO and CloudSat masks are paired:

1. CALIPSO is cloud-free in the column, and CloudSat reports clouds.
2. CALIPSO reports clouds, and CloudSat is cloud-free in the column.
3. Both CALIPSO and CloudSat report clouds somewhere in the column.

If only one of the paired profiles is invalid or one of the instruments did not take valid measurements, the algorithm relies on the valid profile from one instrument.

After identifying the three cloud mask combinations described above, cloud masks of profiles within the CERES footprint are compared at each vertical level from each instrument to begin the grouping process. The vertical resolution of the CALIPSO profile is 30 m below the altitude of 8.2 km and 60 m above the altitude of 8.2 km. The vertical resolution of the CloudSat profile is 480 m and the data are oversampled every 240 m. Comparing cloud masks layer by layer, identical profiles are grouped. Where both CALIPSO and CloudSat profiles are cloudy, all profiles in which cloud boundaries exactly match are grouped together. If the number of resulting groups is less than 16, all groups are kept. If that number is exceeded, similar and less populated profiles are combined together until the number becomes less than or equal to 16.

To determine the number of layers, the profile is traversed downward, i.e., from TOA to the surface. Starting from the top of the profile, the height of the level where the cloud layer starts is defined as the top height. Whenever CALIPSO identifies a cloud top, the cloud top is kept. In addition, if CloudSat identifies a cloud top at the height where the distance from any CALIPSO identified cloud top is greater than 480 m, the CloudSat cloud top is added. If CloudSat detects a cloud top and there is a corresponding CALIPSO top within 480 m, the CALIPSO top height is used. An additional cloud top is added after detecting a cloud layer and after a layer(s) where CALIPSO detects a cloud-free area. These processes are repeated until the surface is reached or CALIPSO is completely attenuated and CloudSat detects no clouds below the complete attenuation level. Reported base height is the height of the top level of the first cloud-free layer below a cloud layer in the profile. Because all CALIPSO cloud base heights are kept, there may be multiple cloud bases if there are breaks in the CALIPSO profile even if CloudSat detects a single layer cloud. If the CALIPSO profile is completely attenuated and there is no corresponding CloudSat cloud, then the base is the lowest height where CALIPSO detected the signal. If the number of layers in an atmospheric column exceeds six, the top (base) of the lower (upper) layer of two layers with minimum separation between base and top is removed. This is repeated until the number of layers equals six.

The process to reduce the number of cloud groups when it exceeds 16 is described here. First, the number of unique profiles within the three cases listed above is determined. If the number of unique profiles in the case is within the limit of 16, no combining is done for the case. If the limit is exceeded, all cloud groups that contain nine or more vertical profiles are kept. Remaining profiles that have small cloud height differences between them are combined. If this process does not reduce the number of groups to 16, a larger height difference than that used in the previous combining process is adopted, and the combining process is repeated until the number of cloud groups becomes 16 or less. Cloud fractions before and after this cloud grouping process can differ slightly; the difference is discussed in Kato et al. (2010).

For aerosols, 16 aerosol layers identified by CALIPSO are kept over a cloud-free area. One aerosol layer overlapping with each cloud group is kept.

CCCM-6 Total number of CloudSat profiles

Number of CloudSat profiles over a CERES footprint.

CCCM-7 Total number of CloudSat clear profiles

Number of cloud-less CloudSat profiles over a CERES footprint.

CCCM-8 Total number of good CloudSat profiles

Number of non-default CloudSat profiles over a CERES footprint.

CCCM-9 Total number of CALIPSO profiles

Number of CALIPSO profiles over a CERES footprint.

CCCM-10 Total number of CALIPSO clear profiles

Number of cloud-less CALIPSO profiles over a CERES footprint.

CCCM-11 Total number of good CALIPSO profiles

Number of non-default CALIPSO profiles over a CERES footprint.

After the recovery of CloudSat failure due to the battery anomaly in 2011, CloudSat had been daylight-only operations (DO-Op). In other words, CALIPSO is only available during nighttime, causing a degraded accuracy in the computed irradiances. In addition, one of CloudSat and CALIPSO did not operate occasionally, causing an increased uncertainty in the computed irradiances. In order to use more reliable computed irradiances with valid CloudSat and CALIPSO measurements, CCCM-8 and CCCM-11 need to be checked whether these are at least greater than 28 and 90, respectively.

CCCM-12 Cloud group area percent coverage

PSF-weighted percent coverage of each cloud group (up to 16) over the CERES footprint. This is the sum of the PSF weight for profiles in a cloud group divided by the total PSF weight of all profiles. All profiles do not include bad profiles (those when both CALIPSO and CloudSat profiles are bad). The sum of the cloud area of all groups should be equal to 100 - Clear (cloud-free) area percent coverage (CCCM-21).

CCCM-13 Cloud layer top level height

Cloud layer top level height corresponding to the cloud group area percent coverage in CCCM-12.

CCCM-14 Cloud top source flag

The source flag is a two-digit number.

The highest order digit indicates either 1–CALIPSO height or 2–CloudSat height was used.

The second digit indicates which instrument saw the cloud:

- 1–CALIPSO
- 2–CloudSat
- 3–Both CALIPSO and CloudSat
- 4–CALIPSO attenuation added

The allowable flags are therefore:

- 11–CALIPSO only
- 13–CALIPSO height, but CloudSat also reported clouds between top and base
- 22–CloudSat only

23–CloudSat height, but CALIPSO also reported clouds between top and base
 24–CloudSat height, but CALIPSO was completely attenuated before CloudSat top
 127–default value

CCCM-15 Cloud layer base level height

Cloud layer base level height corresponding to the cloud layer top level height in CCCM-13.

CCCM-16 Cloud base source flag

The source flag is a two-digit number.

The highest order digit indicates either 1–CALIPSO height or 2–CloudSat height was used.

The second digit indicates which instrument saw the cloud:

- 1 = CALIPSO
- 2 = CloudSat
- 3 = Both CALIPSO and CloudSat
- 4 = CALIPSO attenuation added

The allowable flags are therefore:

- 11 = CALIPSO only
- 13 = CALIPSO height, but CloudSat also reported clouds between top and base
- 14 = CALIPSO height used, but CALIPSO was attenuated at base layer (i.e. CALIPSO base lower than CloudSat or no CloudSat clouds in layer)
- 22 = CloudSat only
- 23 = CloudSat height, but CALIPSO also reported clouds between top and base
- 24 = CloudSat height, but CALIPSO was completely attenuated before CloudSat base
- 127 = default value

CCCM-16a Mean CALIPSO cloud layer Mask QA flag

The mean of the QA flag assigned to each CALIPSO profile bin with a feature mask of cloud used for that specific cloud group and layer.

CCCM-16b Mean CALIPSO cloud layer phase

The mean of the phase assigned to each CALIPSO profile bin with a feature mask of cloud used for that specific cloud group and layer..

CCCM-16c Mean CALIPSO cloud layer phase QA flag

The mean of the QA flag assigned to each CALIPSO profile bin with a feature mask of cloud used for that specific cloud group and layer.

CCCM-16d CALIPSO cloud layer horizontal average histogram

The number of CALIPSO profile bin with a feature mask of cloud used for that specific cloud group and layer with the given horizontal average, 0.30, 1, 5, 20, and 80 km assigned to it.

CCCM-17 Precipitation flag CloudSat

The predominant precipitation type, if present, from the CloudSat CLDCLASS Precipitation flag. Otherwise, it is set to zero.

- 0 = no precipitation
- 1 = liquid precipitation
- 2 = solid precipitation
- 3 = possible drizzle

This flag is used for filtering 2B-CWC liquid products for precipitating cases. That is, if the flag is 1 (liquid precipitation) or 3 (possible drizzle), 2B-CWC liquid profiles are not used for irradiance computations because the liquid water content and extinction coefficient is often overestimated.

CCCM-18 CALIPSO aerosol layer (overlap with cloud) top level height

The top height of the thickest aerosol layer within the cloud group. Aerosol layer height is determined by CALIPSO (from VFM product). One layer per cloud group is kept within a CERES footprint.

CCCM-19 CALIPSO aerosol layer (overlap with cloud) base level height

The base height of the thickest aerosol layer within the cloud group. Aerosol layer height is determined by CALIPSO (from VFM product). One layer per cloud group is kept within a CERES footprint. The physically thickest aerosol layer overlapping with the cloud group is selected.

CCCM-20 Mean CALIPSO signal attenuation top level height (cloudy)

Mean height that the CALIPSO signal is completely attenuated within each cloud group.

CCCM-21 Cloud free area percent coverage (CALIPSO-CloudSat)

PSF-weighted percent coverage of the cloud-free area, i.e., the sum of the PSF-weighted cloud-free profiles divided by the total PSF weight of good profiles. The cloud mask is based on CALIPSO and CloudSat. Cloud-free profiles are those in which both CALIPSO and CloudSat profiles do not have clouds. If either of the CALIPSO or CloudSat profiles is bad, clouds are identified from the other good profile. If both of the CALIPSO and CloudSat profiles are bad, the profile is excluded from both the denominator and numerator in computing coverage. If the CALIPSO signal is attenuated by aerosol layers and the collocated CloudSat profile does not contain any clouds, the profile is considered to be a cloud-free profile. For example, thick smoke (aerosols) sometimes completely attenuates the CALIPSO signal. When this complete attenuation by aerosol occurs, it is assumed that this CALIPSO profile is clear (cloud-free) unless CloudSat detects clouds below the complete attenuation level.

CCCM-22 CALIPSO aerosol area percent coverage without clouds

PSF-weighted percent coverage of cloud-free area with the presence of aerosols, i.e., the sum of PSF weight of profiles with aerosol but without clouds divided by the total PSF weight of good profiles. Aerosol layers are identified by CALIPSO.

CCCM-23 CALIPSO aerosol layer (over clear area) top level height

Top height of the aerosol layers over the cloud-free area identified by CALIPSO. The aerosol layers from all CALIPSO (from VFM product) cloud-free profiles within a CERES footprint are combined into one profile. The aerosol layer height is determined by traversing the profile from TOA to the surface or the attenuation layer, similar to the method used to determine cloud top heights. The height of the top level of the first layer with aerosol is used. This step is repeated after each aerosol-free layer. Up to sixteen layers are kept within a CERES footprint.

CCCM-24 CALIPSO aerosol layer (over clear area) base level height

Base height of the aerosol layers over the cloud-free area identified by CALIPSO. The aerosol mask from all CALIPSO (from VFM product) cloud-free profiles are combined into one profile. The height of the top level of the first aerosol-free layer after aerosols are detected is used. Up to sixteen layers are kept.

CCCM-25 Mean CALIPSO signal attenuation top level height (aerosol area)

Mean height of the level of the first layer in which the CALIPSO signal is completely attenuated by aerosols in cloud-free profiles. Not currently filled. Values are set to zero.

CCCM-26 CALIPSO signal attenuation area percent coverage

Percent coverage of area over a CERES footprint in which CALIPSO signal is completely attenuated, i.e., the sum of the PSF weight of profiles with attenuation divided by the total PSF weight of good profiles.

2.3 MODIS Properties over CALIPSO and CloudSat Groups

The parameters in this group (CCCM-27 through CCCM-36) describe coverage and cloud properties derived from MODIS for the track and enhanced track sets (i.e. standard and enhanced cloud algorithms along the CALIPSO/CloudSat track). These two sets are reflected in the second SDS dimension, which is 2. The cloud properties are given for up to 16 cloud groups, indicated by the third SDS dimension.

The enhanced algorithm is a simple improved MODIS cloud retrieval algorithm. The improvement is achieved using the CALIPSO and CloudSat cloud mask. If the MODIS-derived cloud top height is different from the topmost cloud top height derived from CALIPSO and CloudSat, the algorithm changes the cloud top height. If the optical thickness is less than 2, the MODIS cloud top is placed halfway between the merged cloud top and base. If the optical thickness is greater than 2, the top is placed at the optical thickness of 1 from the top. After changing the cloud top height, the same standard cloud algorithm (as the standard retrieval) is then applied.

CCCM-27 Clear area percent coverage from MODIS

Percent coverage of MODIS-derived clear area over the cloud-free portion identified by CALIPSO and CloudSat. When there is no clear sky according to CALIPSO and CloudSat, a default value is used.

CCCM-28 Cloud percent coverage over group area from MODIS

PSF-weighted MODIS-derived cloud percent coverage over each cloud group defined by CCCM-13 and CCCM-15.

CCCM-29 Mean group visible optical depth from MODIS radiance

Mean PSF-weighted MODIS-derived cloud optical depth averaged over each cloud group. Cloud optical depth is derived by both the CERES standard and enhanced cloud algorithms.

CCCM-30 Mean group logarithm of visible optical depth from MODIS rad

Mean PSF-weighted natural logarithm of MODIS-derived cloud optical depth averaged over each cloud group. Cloud optical depth is derived by the CERES standard and enhanced cloud algorithms.

CCCM-30a Mean group cloud top effective temperature from MODIS radiance

Mean PSF-weighted MODIS-derived cloud top effective temperature by the CERES standard and enhanced cloud algorithms derived for each cloud group.

CCCM-31 Mean group cloud top height from MODIS radiance

Mean PSF-weighted MODIS-derived cloud top height by the CERES standard and enhanced cloud algorithms over each cloud group. MODIS cloud top heights are above ground level.

CCCM-32 Mean group water particle radius from MODIS rad (3.7)

Mean PSF-weighted water cloud particle effective radius derived from the MODIS 3.7 micron channel over each cloud group. Cloud phase is identified by MODIS.

CCCM-33 Mean group ice particle generalized effective radius from MODIS rad (3.7)

Mean PSF-weighted ice cloud particle effective radius derived from the MODIS 3.7 micron channel over each cloud group. Cloud phase is identified by MODIS. To obtain the effective diameter, multiply CCCM-33 by 2.

CCCM-34 Mean group cloud particle phase from MODIS radiance (3.7)

Mean PSF-weighted particle phase derived from the MODIS 3.7 micron channel over each cloud group. Water is one, and ice is two.

CCCM-35 Mean group water particle radius from MODIS radiance (2.1)

Mean PSF-weighted water cloud particle effective radius derived from the MODIS 2.1 micron channel over each cloud group. Cloud phase is identified by MODIS using the 3.7 micron channel.

CCCM-36 Mean group ice particle generalized effective radius from MODIS rad (2.1)

Mean PSF-weighted ice cloud particle effective radius derived from the MODIS 2.1 micron channel over each cloud group. Cloud phase is identified by MODIS using the 3.7 micron channel. To obtain the effective diameter, multiply CCCM-36 by 2.

2.4 CALIPSO Aerosol Layer Mean

Up to 16 aerosol layers within a CERES footprint are kept. All aerosol layers included in the CALIPSO 5 km aerosol layer mean product are included without either mixing or averaging across multiple layers if there are less than 16 layers within a CERES footprint. If the number of layers exceeds 16, then some layers are merged. The merging process is done using the horizontal averaging distance reported in the layer product, starting at 5 km and going to 20 km and 80 km. The number of aerosol layers in each horizontal averaging group is reduced to five to six layers. In the process, the two aerosol layers that have the minimum absolute difference in top and base heights are combined. This procedure is repeated until sixteen layers are reached. In the cases where layers are combined, the values for the combined layers PSF-weighted mean is reported.

CCCM-37 CALIPSO aerosol layer percent coverage

Percent coverage of the area over a CERES footprint that the CALIPSO aerosol layer covers multiplied by 100 (i.e. a scaling factor of 0.01 to convert to percent coverage). The coverage for up to 16 aerosol layers is reported. The coverage is computed by the sum of the PSF weight of MODIS pixels with this aerosol layer assigned divided by the total PSF weight of MODIS pixels along the track.

CCCM-38 CALIPSO aerosol layer top level height

Aerosol layer top height extracted from the CALIPSO 5 km aerosol layer mean product.

CCCM-39 CALIPSO aerosol layer base level height

Aerosol layer base height extracted from the CALIPSO 5 km aerosol layer mean product.

CCCM-40 CALIPSO aerosol layer opacity flag

Opacity flag extracted from the CALIPSO 5 km aerosol layer mean product. Opaque is 1 and transparent is 0.

CCCM-41 CALIPSO aerosol layer horizontal averaging distance

Horizontal averaging distance extracted from the CALIPSO 5 km aerosol layer mean product.

CCCM-42 CALIPSO aerosol layer feature classification flags

Feature classification flags extracted from the CALIPSO 5 km aerosol layer mean product.

Flags are:

- 0 = not determined
- 1 = clean marine
- 2 = dust
- 3 = polluted continental
- 4 = clean continental
- 5 = polluted dust
- 6 = smoke
- 7 = other

CCCM-43 Mean CALIPSO aerosol feature optical depth at 532 nm

CALIPSO-derived aerosol optical depths over a CERES footprint extracted from the CALIPSO 5 km aerosol layer mean product. The aerosol layer top and base heights are in CCCM-38 and CCCM-39. In averaging the aerosol optical depth, values with the Column_Optical_Depth_Aerosols_Uncertainty = 99.99 are excluded from the average. When CALIPSO reports a negative aerosol optical depth, a value greater than -0.1 is included in the mean, but a value less than -0.1 is excluded.

CCCM-44 Mean CALIPSO aerosol feature optical depth uncertain at 532 nm

CALIPSO-derived aerosol optical depth uncertainty over a CERES footprint extracted from the CALIPSO 5 km aerosol layer mean product. The aerosol layer top and base heights are in CCCM-38 and CCCM-39. CCCM-44 and the mean col_OD_Aerosol_Uncertare default when there is no aerosol in a CERES footprint.

CCCM-45 Mean CALIPSO aerosol feature optical depth at 1064 nm

CALIPSO-derived aerosol optical depths over a CERES footprint extracted from the CALIPSO 5 km aerosol layer mean product. The aerosol layer top and base heights are in CCCM-38 and CCCM-39.

CCCM-46 Mean CALIPSO aerosol feature optical depth uncertain at 1064 nm

CALIPSO-derived aerosol optical depth uncertainty over a CERES footprint extracted from the CALIPSO 5 km aerosol layer mean product. The aerosol layer top and base heights are in CCCM-38 and CCCM-39.

CCCM-47 Mean CALIPSO relative humidity in aerosol layer

Relative humidity of the aerosol layer extracted from the CALIPSO 5 km aerosol layer mean product. The aerosol layer top and base heights are in CCCM-38 and CCCM-39.

CCCM-47a Mean CALIPSO feature transmittance at 532 nm

CALIPSO-derived two-way transmittance at 532 nm over a CERES footprint extracted from the CALIPSO 5 km aerosol layer mean product. The aerosol layer top and base heights are in CCCM-38 and CCCM-39.

CCCM-47b Stdev CALIPSO feature transmittance at 532 nm

The standard deviation of the CALIPSO-derived two-way transmittance at 532 nm over a CERES footprint extracted from the CALIPSO 5 km aerosol layer mean product. The aerosol layer top and base heights are in CCCM-38 and CCCM-39.

CCCM-47c Mean CALIPSO feature transmittance uncertainty at 532 nm

CALIPSO-derived two-way transmittance uncertainty at 532 nm over a CERES footprint extracted from the CALIPSO 5 km aerosol layer mean product. The aerosol layer top and base heights are in CCCM-38 and CCCM-39.

CCCM-47d Mean CALIPSO feat integrated attenuated backscatter at 532 nm

CALIPSO-derived integrated attenuated backscatter at 532 nm over a CERES footprint extracted from the CALIPSO 5 km aerosol layer mean product. The aerosol layer top and base heights are in CCCM-38 and CCCM-39.

CCCM-48 Mean CALIPSO aerosol layer CAD score

CAD score of the aerosol layer extracted from the CALIPSO 5 km aerosol layer mean product.

CCCM-49 Mean CALIPSO aerosol optical thickness at 532 nm

PSF-weighted mean aerosol optical thickness over the cloud-free area according to CALIPSO and CloduSat. For each MODIS pixel, the column aerosol optical thickness is extracted from the CALIPSO 5 km aerosol layer mean product. In averaging aerosol optical depth, values with the `Column_Optical_Depth_Aerosols_Uncertainty = 99.99` are excluded from the average. When CALIPSO reports a negative aerosol optical depth, a value greater than -0.1 is included in the mean, but a value less than -0.1 is excluded.

CCCM-50 Stdev of CALIPSO aerosol optical thickness at 532 nm

Standard deviation of the PSF-weighted aerosol optical thickness over the cloud-free area. For each MODIS pixel, the column aerosol optical thickness is extracted from the layer optical depth from the CALIPSO 5 km aerosol layer mean product.

CCCM-50a Mean CALIPSO aerosol optical thickness uncertainty at 532 nm

PSF-weighted mean aerosol optical thickness uncertainty over the cloud-free area. For each MODIS pixel, the column aerosol optical thickness uncertainty is extracted from the CALIPSO 5 km aerosol layer mean product.

CCCM-50b Stdev of CALIPSO aerosol optical thickness uncertain at 532 nm

Standard deviation of the PSF-weighted aerosol optical thickness uncertainty over the cloud-free area. For each MODIS pixel, the column aerosol optical thickness uncertainty is extracted from the CALIPSO 5 km aerosol layer mean product.

CCCM-50c Mean CALIPSO aerosol optical thickness at 1064 nm

PSF-weighted mean aerosol optical thickness over the cloud-free area. For each MODIS pixel, the column aerosol optical thickness is extracted from the CALIPSO 5 km aerosol layer mean product. In averaging aerosol optical depth, values with the `Column_Optical_Depth_Aerosols_Uncertainty = 99.99` are excluded from the average. When CALIPSO reports a negative aerosol optical depth, a value greater than -0.1 is included in the mean, but a value less than -0.1 is excluded.

CCCM-50d Stdev of CALIPSO aerosol optical thickness at 1064 nm

Standard deviation of PSF-weighted aerosol optical thickness over cloud free area. For each MODIS pixel, the column aerosol optical thickness is calculated from the layer optical depth from the CALIPSO 5 km aerosol layer mean product.

CCCM-50e Mean CALIPSO aerosol optical thickness uncertainty at 1064 nm

PSF-weighted mean aerosol optical thickness uncertainty over the cloud-free area. For each MODIS pixel, the column aerosol optical thickness uncertainty is extracted from the CALIPSO 5 km aerosol layer mean product.

CCCM-50f Stdev of CALIPSO aerosol optical thickness uncertain at 1064 nm

Standard deviation of the PSF-weighted aerosol optical thickness uncertainty over the cloud-free area. For each MODIS pixel, the column aerosol optical thickness uncertainty is extracted from the CALIPSO 5 km aerosol layer mean product.

CCCM-50g Mean CALIPSO col strat aerosol optical depth at 532 nm

PSF-weighted mean CALIPSO column stratospheric aerosol optical depth at 532 nm. For each MODIS pixel, the column stratospheric aerosol optical thickness is extracted from the CALIPSO 5 km aerosol layer mean product. In averaging aerosol optical depth, values with the `Column_Optical_Depth_Stratospheric_Aerosols_Uncertainty_532 = 99.99` are excluded from the average. When CALIPSO reports a negative aerosol optical depth, a value greater than -0.1 is included in the mean, but a value less than -0.1 is excluded.

CCCM-50h Stdev CALIPSO col strat aerosol optical depth at 532 nm

PSF-weighted standard deviation of the CALIPSO column stratospheric aerosol optical depth at 532nm. For each MODIS pixel, the column stratospheric aerosol optical thickness is extracted from the CALIPSO 5 km aerosol layer mean product. In averaging aerosol optical depth, values with the `Column_Optical_Depth_Stratospheric_Aerosols_Uncertainty_532 = 99.99` are excluded from the average. When CALIPSO reports a negative aerosol optical depth, a value greater than -0.1 is included in the mean, but a value less than -0.1 is excluded.

CCCM-50i Mean CALIPSO col strat aerosol optical depth uncert at 532 nm

PSF-weighted mean CALIPSO column stratospheric aerosol optical depth uncertainty at 532nm. For each MODIS pixel, the column stratospheric aerosol optical thickness uncertainty is extracted from the CALIPSO 5 km aerosol layer mean product. In averaging aerosol optical depth, values with the `Column_Optical_Depth_Stratospheric_Aerosols_Uncertainty_532 = 99.99` are excluded from the average. When CALIPSO reports a negative aerosol optical depth, a value greater than -0.1 is included in the mean, but a value less than -0.1 is excluded.

CCCM-50j Stdev CALIPSO col strat aerosol optical depth uncert at 532 nm

PSF-weighted standard deviation of the CALIPSO column stratospheric aerosol optical depth uncertainty at 532nm. For each MODIS pixel, the column stratospheric aerosol optical thickness uncertainty is extracted from the CALIPSO 5 km aerosol layer mean product. In averaging aerosol optical depth, values with the `Column_Optical_Depth_Stratospheric_Aerosols_Uncertainty_532 = 99.99` are excluded from the average. When CALIPSO reports a negative aerosol optical depth, a value greater than -0.1 is included in the mean, but a value less than -0.1 is excluded.

CCCM-50k Mean CALIPSO col strat aerosol optical depth at 1064 nm

PSF-weighted mean CALIPSO column stratospheric aerosol optical depth at 1064nm. For each MODIS pixel, the column stratospheric aerosol optical thickness is extracted from the CALIPSO

5 km aerosol layer mean product. In averaging aerosol optical depth, values with the Column_Optical_Depth_Stratospheric_Aerosols_Uncertainty_1064 = 99.99 are excluded from the average. When CALIPSO reports a negative aerosol optical depth, a value greater than -0.1 is included in the mean, but a value less than -0.1 is excluded.

CCCM-50l Stdev CALIPSO col strat aerosol optical depth at 1064 nm

PSF-weighted standard deviation of the CALIPSO column stratospheric aerosol optical depth at 1064nm. For each MODIS pixel, the column stratospheric aerosol optical thickness is extracted from the CALIPSO 5 km aerosol layer mean product. In averaging aerosol optical depth, values with the Column_Optical_Depth_Stratospheric_Aerosols_Uncertainty_1064 = 99.99 are excluded from the average. When CALIPSO reports a negative aerosol optical depth, a value greater than -0.1 is included in the mean, but a value less than -0.1 is excluded.

CCCM-50m Mean CALIPSO col strat aerosol optical depth uncert at 1064 nm

PSF-weighted mean CALIPSO column stratospheric aerosol optical depth uncertainty at 1064nm. For each MODIS pixel, the column stratospheric aerosol optical thickness uncertainty is extracted from the CALIPSO 5 km aerosol layer mean product. In averaging aerosol optical depth, values with the Column_Optical_Depth_Stratospheric_Aerosols_Uncertainty_1064 = 99.99 are excluded from the average. When CALIPSO reports a negative aerosol optical depth, a value greater than -0.1 is included in the mean, but a value less than -0.1 is excluded.

CCCM-50n Stdev CALIPSO col strat aerosol optical depth at 532 nm

PSF-weighted standard deviation of the CALIPSO column stratospheric aerosol optical depth at 1064nm. For each MODIS pixel, the column stratospheric aerosol optical thickness uncertainty is extracted from the CALIPSO 5 km aerosol layer mean product. In averaging aerosol optical depth, values with the Column_Optical_Depth_Stratospheric_Aerosols_Uncertainty_1064 = 99.99 are excluded from the average. When CALIPSO reports a negative aerosol optical depth, a value greater than -0.1 is included in the mean, but a value less than -0.1 is excluded.

2.5 Cloud Layer Mean

Variables included as cloud layer mean properties are extracted from the CALIPSO Lidar Level 2 5 km cloud layer and Lidar Level 2 5 km cloud profile products; and the CloudSat 2B-CLDCLASS and 2B-CWC-RO products. Native vertical resolutions used in these products are used here. The properties extracted from the CALIPSO 5 km cloud profile product are from 345 vertical layers, the heights of which are given by CCCM-125 and -126. The properties extracted from CloudSat products are assigned to 113 vertical layers, the heights of which are given by CCCM-121 and -122.

CCCM-51 CALIPSO layer cloud type profile

The predominant cloud type (most frequently occurring) from CALIPSO extracted from the CALIPSO VFM feature flag is assigned to each layer.

- 0 = low overcast, transparent
- 1 = low overcast, opaque
- 2 = transition stratocumulus
- 3 = low, broken cumulus

- 4 = altocumulus (transparent)
- 5 = altostratus (opaque)
- 6 = cirrus (transparent)
- 7 = deep convective (opaque)

CCCM-52 Cloud fraction profile

Volumetric cloud fraction vertical profile derived from CALIPSO and CloudSat data. It is the percentage of CALIPSO bins within the model layer in all valid profiles with clouds to the total number of bins within the model layer in all valid profiles. CloudSat clouds are assigned to CALIPSO bins.

Note that CCCM-52 cloud fraction is computed as overcast if CALIPSO and/or CloudSat have valid cloud profiles, which is a different approach from [Table 1-3](#) (Kato et al., 2010). If we use cloud top and base heights of 16 cloud groups (CCCM-13) and (CCCM-15), which comes the merging strategy of [Table 1-3](#), for computing cloud fraction profiles, the results are slightly different from CCCM-52. This is because the merging strategy in [Table 1-3](#) does not always assume an overcast condition when CloudSat detects clouds.

CCCM-53 Mean CALIPSO cloud layer CAD score

PSF-weighted CAD score extracted from the CALIPSO 5 km cloud layer mean product.

CCCM-54 Mean CALIPSO cloud layer extinction coefficient at 532 nm

PSF-weighted mean CALIPSO-derived extinction coefficient profile from the CALIPSO 5 km cloud profile product. Extinctions with QC flag = 0, 1, 2, 16, or 18 and a CAD score from -100 to 100 are included in the average. Below 8.2 km, a QC flag is reported for each 30 m bin of the 60 m layer. When one of the 30 m resolution QC flags (upper or lower 30 m) is default in the CALIPSO 5 km cloud profile product, the other value is taken. When both flags have valid values, the larger value is taken.

CCCM-55 Mean CALIPSO constrained cloud layer extinction coeff at 532 nm

PSF-weighted mean CALIPSO-derived extinction coefficient profile from the CALIPSO 5 km cloud profile product. Extinctions with QC flag = 1 and a CAD score from -100 to 100 are included in the average.

CCCM-56 Mean logarithm of CALIPSO extinction coefficient at 532 nm

PSF-weighted mean logarithm of CALIPSO-derived extinction coefficient profile from the CALIPSO 5 km cloud profile product. Extinctions with QC flag = 0, 1, 2, 16, or 18 and a CAD score from -100 to 100 are included in the average.

CCCM-57 CALIPSO extinction coefficient uncertainty at 532 nm

PSF-weighted mean extinction coefficient uncertainty profile from the CALIPSO 5 km cloud profile product. Currently, this variable contains only a default value.

CCCM-58 Mean CALIPSO ice water content

PSF-weighted mean CALIPSO ice water content profile from CALIPSO 5 km cloud product.

CCCM-59 Stdev of CALIPSO ice water content

PSF-weighted standard deviation of CALIPSO ice water content profile from CALIPSO 5 km cloud product.

CCCM-60 CALIPSO ice water content uncertainty

PSF-weighted mean CALIPSO ice water content uncertainty profile from CALIPSO 5 km cloud product.

CCCM-60a Mean CALIPSO cloud optical depth at 532 nm

PSF-weighted mean cloud optical depth at 532 nm. For each MODIS pixel, the column cloud optical depth is extracted from the CALIPSO 5 km cloud profile product. In averaging cloud optical depth, values with Column_Optical_Depth_Cloud_Uncertainty = 99.99 are excluded from the average. When CALIPSO report a negative cloud optical depth, the value greater than -0.1 is included in the mean but the value less than -0.1 is excluded.

CCCM-60b Stdev of CALIPSO cloud optical depth at 532 nm

Standard deviation of PSF-weighted cloud optical depth at 532 nm. For each MODIS pixel, the column cloud optical depth is extracted from the CALIPSO 5 km cloud profile product. Cloud optical depths with the Column_Optical_Depth_Cloud_Uncertainty = 99.99 are excluded from the standard deviation. When CALIPSO report a negative cloud optical depth, the value greater than -0.1 is included but the value less than -0.1 is excluded.

CCCM-60c Mean CALIPSO cloud optical depth uncertainty at 532 nm

PSF-weighted mean cloud optical depth uncertainty at 532 nm. For each MODIS pixel, the column cloud optical depth uncertainty is extracted from the CALIPSO 5 km cloud profile product. In averaging cloud optical depth uncertainty, values with the Column_Optical_Depth_Cloud_Uncertainty = 99.99 are excluded from the average.

CCCM-60d Stdev of CALIPSO cloud optical depth uncertainty at 532 nm

Standard deviation of PSF-weighted mean cloud optical depth uncertainty at 532 nm. For each MODIS pixel, the column cloud optical depth uncertainty is extracted from the CALIPSO 5 km cloud profile product. In averaging cloud optical depth uncertainty, values with Column_Optical_Depth_Cloud_Uncertainty = 99.99 are excluded from the average.

CCCM-60e Mean CALIPSO 5 km cloud layer optical depth at 532 nm

CALIPSO-derived 5-km cloud layer optical depth at 532 nm within a CERES footprint extracted from the CALIPSO 5 km cloud layer mean product. The cloud layer top and base heights are in CCCM-60m and CCCM-60o. In averaging the cloud optical depth, values with the Column_Optical_Depth_Cloud_Uncertainty_532 = 99.99 are excluded from the average. When CALIPSO reports a negative cloud optical depth, a value greater than -0.1 is included in the mean, but a value less than -0.1 is excluded.

CCCM-60f Stdev of CALIPSO 5 km cloud layer optical depth at 532 nm

Standard deviation of the CALIPSO-derived 5-km cloud layer optical depth at 532 nm within a CERES footprint extracted from the CALIPSO 5 km cloud layer mean product. The cloud layer top and base heights are in CCCM-60m and CCCM-60o. In averaging the cloud optical depth,

values with the `Column_Optical_Depth_Cloud_Uncertainty_532 = 99.99` are excluded from the average. When CALIPSO reports a negative cloud optical depth, a value greater than -0.1 is included in the mean, but a value less than -0.1 is excluded.

CCCM-60g Mean CALIPSO 5 km cloud layer optical depth uncert at 532 nm

CALIPSO-derived 5-km cloud layer optical depth uncertainty at 532 nm within a CERES footprint extracted from the CALIPSO 5 km cloud layer mean product. The cloud layer top and base heights are in CCCM-60m and CCCM-60o.

CCCM-60h Mean CALIPSO 5 km cloud layer 2-way transmit at 532 nm

CALIPSO-derived 5-km cloud layer 2-way transmittance at 532 nm within a CERES footprint extracted from the CALIPSO 5 km cloud layer mean product. The cloud layer top and base heights are in CCCM-60m and CCCM-60o.

CCCM-60i Stdev CALIPSO 5 km cloud layer 2-way transmit at 532 nm

Standard deviation of the CALIPSO-derived 5-km cloud layer 2-way transmittance at 532 nm within a CERES footprint extracted from the CALIPSO 5 km cloud layer mean product. The cloud layer top and base heights are in CCCM-60m and CCCM-60o.

CCCM-60j Mean CALIPSO 5 km cloud layer 2-way transmit uncert at 532 nm

CALIPSO-derived 5-km cloud layer 2-way transmittance uncertainty at 532 nm over a CERES footprint extracted from the CALIPSO 5 km cloud layer mean product. The cloud layer top and base heights are in CCCM-60m and CCCM-60o

CCCM-60k Stdev CALIPSO 5 km cloud layer 2-way transmit uncert at 532 nm

Standard deviation of the CALIPSO-derived 5-km cloud layer 2-way transmittance uncertainty at 532 nm within a CERES footprint extracted from the CALIPSO 5 km cloud layer mean product. The cloud layer top and base heights are in CCCM-60m and CCCM-60o.

CCCM-60l Mean CALIPSO 5 km cloud layer area

Percent coverage of the area over a CERES footprint that the CALIPSO cloud layer covers multiplied by 100 (i.e. a scaling factor of 0.01 to convert to percent coverage). The coverage for up to 16 cloud layers is reported. The coverage is computed by the sum of the PSF weight of MODIS pixels with this cloud layer assigned divided by the total PSF weight of MODIS pixels along the track.

CCCM-60m Mean CALIPSO 5 km cloud layer top height

Cloud layer top height extracted from the CALIPSO 5 km cloud layer mean product.

CCCM-60n Stdev CALIPSO 5 km cloud layer top height

Standard deviation of the cloud layer top height extracted from the CALIPSO 5 km cloud layer mean product.

CCCM-60o Mean CALIPSO 5-km cloud layer base height

Cloud layer base height extracted from the CALIPSO 5 km cloud layer mean product.

CCCM-60p Stdev CALIPSO 5 km cloud layer base height

Standard deviation of the cloud layer base height extracted from the CALIPSO 5 km cloud layer mean product.

CCCM-60q CALIPSO 5 km cloud layer opacity flag

Cloud layer opacity flag extracted from the CALIPSO 5 km cloud layer mean product.

CCCM-60r Mean CALIPSO 5 km cloud layer horizontal average

Cloud layer horizontal average extracted from the CALIPSO 5 km cloud layer mean product.

CCCM-60s Mean CALIPSO 5 km cloud layer CAD score

Cloud layer CAD score extracted from the CALIPSO 5 km cloud layer mean product.

CCCM-60t Mean CALIPSO 5 km ss cloud layer top height

Single-shot cloud layer top height extracted from the CALIPSO 5 km cloud layer mean product.

CCCM-60u Stdev CALIPSO 5 km ss cloud layer top height

Standard deviation of the single-shot cloud layer top height extracted from the CALIPSO 5 km cloud layer mean product.

CCCM-60v Mean CALIPSO 5-km ss cloud layer base height

Single-shot cloud layer base height extracted from the CALIPSO 5 km cloud layer mean product.

CCCM-60w Stdev CALIPSO 5 km ss cloud layer base height

Standard deviation of the single-shot cloud layer base height extracted from the CALIPSO 5 km cloud layer mean product.

CCCM-60x Mean CALIPSO 5 km ss cloud layer intel attenuated backscatter

CALIPSO-derived 5-km single-shot cloud layer 2-way integrated attenuated backscatter within a CERES footprint extracted from the CALIPSO 5 km cloud layer mean product. The cloud layer top and base heights are in CCCM-60t and CCCM-60v.

CCCM-60y Stdev CALIPSO 5 km ss cloud layer integ attenuated backscatter

Standard deviation of the CALIPSO-derived 5-km single-shot cloud layer 2-way integrated attenuated backscatter within a CERES footprint extracted from the CALIPSO 5 km cloud layer mean product. The cloud layer top and base heights are in CCCM-60t and CCCM-60v.

CCCM-60z Mean CALIPSO 5 km ss cloud layer atten backscat stats at 532 nm

CALIPSO-derived 5-km single-shot cloud layer 2-way attenuated backscatter statistics at 532 nm within a CERES footprint extracted from the CALIPSO 5 km cloud layer mean product. The cloud layer top and base heights are in CCCM-60t and CCCM-60v.

CCCM-60aa Stdev CALIPSO 5 km ss cloud layer atten backscat at 532 nm

Standard deviation of the CALIPSO-derived 5-km single-shot cloud layer 2-way attenuated backscatter statistics at 532 nm within a CERES footprint extracted from the CALIPSO 5 km

cloud layer mean product. The cloud layer top and base heights are in CCCM-60t and CCCM-60v.

CCCM-60ab Mean CALIPSO 5 km ss cloud layer atten backscat stats at 1064 nm

CALIPSO-derived 5-km single-shot cloud layer 2-way attenuated backscatter statistics at 1064 nm within a CERES footprint extracted from the CALIPSO 5 km cloud layer mean product. The cloud layer top and base heights are in CCCM-60t and CCCM-60v.

CCCM-60ac Stdev CALIPSO 5 km ss cloud layer atten backscat at 1064 nm

Standard deviation of the CALIPSO-derived 5-km single-shot cloud layer 2-way attenuated backscatter statistics at 1064 nm within a CERES footprint extracted from the CALIPSO 5 km cloud layer mean product. The cloud layer top and base heights are in CCCM-60t and CCCM-60v.

CCCM-60ad Mean CALIPSO 5 km ss cloud layer area

Percent coverage of the area over a CERES footprint that the CALIPSO single-shot cloud layer covers multiplied by 100 (i.e. a scaling factor of 0.01 to convert to percent coverage). The coverage for up to 100 cloud layers is reported. The coverage is computed by the sum of the PSF weight of MODIS pixels with this cloud layer assigned divided by the total PSF weight of MODIS pixels along the track.

CCCM-60ae Mean CALIPSO 5 km ss cloud layer opacity flag

Single-shot cloud layer opacity flag extracted from the CALIPSO 5 km cloud layer mean product.

CCCM-60af Stdev CALIPSO 5 km ss cloud layer opacity flag

Standard deviation of the single-shot cloud layer opacity flag extracted from the CALIPSO 5 km cloud layer mean product.

CCCM-60ag Mean CALIPSO 5 km ss cloud layer CAD score

Single-shot cloud layer CAD score extracted from the CALIPSO 5 km cloud layer mean product.

CCCM-60ah Mean CALIPSO 5 km cloud layer CAD score

Standard deviation of the single-shot cloud layer CAD score extracted from the CALIPSO 5 km cloud layer mean product

CCCM-61 Mean CloudSat radar only liquid effective radius

PSF-weighted mean effective radius of warm clouds derived from the radar-only algorithm from CloudSat 2B-CWC.

CCCM-62 Stdev of CloudSat radar only liquid effective radius

Standard deviation of effective radius of warm clouds derived from the radar-only algorithm from CloudSat 2B-CWC.

CCCM-63 CloudSat radar only liquid effective radius uncertainty

PSF-weighted mean effective radius uncertainty derived from the radar-only algorithm from CloudSat 2B-CWC. Currently, this variable contains only a default value.

CCCM-64 Mean CloudSat radar only ice effective radius

PSF-weighted mean effective radius of ice crystals derived from the radar-only algorithm from CloudSat 2B-CWC.

CCCM-65 Stdev of CloudSat radar only ice effective radius

Standard deviation of effective radius of ice crystals derived from the radar-only algorithm from CloudSat 2B-CWC.

CCCM-66 CloudSat radar only ice effective radius uncertainty

PSF-weighted mean effective radius uncertainty derived from the radar-only algorithm from CloudSat 2B-CWC. Currently, this variable contains only a default value.

CCCM-67 Mean CloudSat radar only liquid water content

PSF-weighted mean liquid water content of warm clouds derived from the radar-only algorithm from CloudSat 2B-CWC.

CCCM-68 Stdev of CloudSat radar only liquid water content

Standard deviation of liquid water content of warm clouds derived from the radar-only algorithm from CloudSat 2B-CWC.

CCCM-69 CloudSat radar only liquid water content uncertainty

PSF-weighted mean liquid water content uncertainty derived from the radar-only algorithm from CloudSat 2B-CWC.

CCCM-70 Mean CloudSat radar only ice water content

PSF-weighted mean ice water content derived from the radar-only algorithm from CloudSat 2B-CWC.

CCCM-71 Stdev of CloudSat radar only ice water content

Standard deviation of ice water content derived from the radar-only algorithm from CloudSat 2B-CWC.

CCCM-72 CloudSat radar only ice water content uncertainty

PSF-weighted mean ice water content uncertainty derived from the radar-only algorithm from CloudSat 2B-CWC.

CCCM-72a Mean CloudSat and CALIPSO ice cloud effective radius

PSF-weighted mean effective radius of ice crystals derived from the CloudSat and CALIPSO combined algorithm from CloudSat 2B-ICE.

CCCM-72b Mean CloudSat and CALIPSO ice cloud effective radius uncert

PSF-weighted mean effective radius uncertainty of ice crystals derived from the CloudSat and CALIPSO combined algorithm from CloudSat 2B-ICE.

CCCM-72c Mean CloudSat and CALIPSO ice cloud water content

PSF-weighted mean ice cloud water content derived from the CloudSat and CALIPSO combined algorithm from CloudSat 2B-ICE.

CCCM-72d Mean CloudSat and CALIPSO ice cloud water content uncert

PSF-weighted mean ice cloud water content uncertainty derived from the CloudSat and CALIPSO combined algorithm from CloudSat 2B-ICE.

CCCM-72e Mean CloudSat and CALIPSO ice cloud extinct coefficient

PSF-weighted mean ice cloud extinction coefficient derived from the CloudSat and CALIPSO combined algorithm from CloudSat 2B-ICE.

CCCM-72f Mean CloudSat and CALIPSO ice cloud extinct coefficient uncert

PSF-weighted mean ice cloud extinction coefficient uncertainty derived from the CloudSat and CALIPSO combined algorithm from CloudSat 2B-ICE.

CCCM-73 CloudSat cloud type histogram

Cloud type histogram derived from CloudSat 2B-CLDCLASS mask; that is, cloud type counts in a CERES footprint divided by the total number of counts multiplied by 10000. In the extreme case, one CloudSat column can provide up to 125 cloud types and typically about 34 columns in a CERES footprint. If all eight cloud types are added, the sum should be 10000 (i.e., 100 times percentage). CloudSat cloud types are:

- 1 = Cirrus
- 2 = Altostratus
- 3 = Altocumulus
- 4 = Stratus
- 5 = Stratocumulus
- 6 = Cumulus
- 7 = Nimbostratus
- 8 = Deep Convection

2.6 Vertical Model Input Profile

This parameter group contains information about the atmospheric and cloud properties used in the model for the irradiance computations.

2.6.1 Cloud Data Sources for Irradiance Computations

Irradiance vertical profiles are computed for each cloud profile group described in the Cloud and Aerosol Mask section as well as for the clear area and averaged, weighted by the area covered by the cloud group and the clear area. The FLUX model for CERES with k -distribution and correlated- k for Radiation (FLCKKR) radiative transfer model (with a 2-stream approximation) is used. First, cloud phase is assigned for each cloudy vertical bin. If temperature < 253.15 K, ice phase is assumed. If temperature > 273.15 K, liquid phase is assumed. For temperature between 253.15 K and 273.15 K, the CALIPSO phase with medium or high confidence is used to

determine the phase of each bin. If the CALIPSO phase is not available, the MODIS column-integrated phase is used for assigning vertical bins between 253.15 K and 273.15 K. Second, depending on the determined phase, different hierarchy is used. For the ice-phase cloud bin, the hierarchy of the cloud parameters is:

1. CloudSat 2C-ICE ice cloud extinction and effective radius.
2. If 1) is not available, CALIPSO-derived extinction (532 nm) coefficient is used. Since CALIPSO does not provide particle size, the ice particle effective radius comes from 2B-CWC cloud profile if it is available. If the 2B-CWC ice effective radius is not available, MODIS column ice effective radius is used. If MODIS ice effective radius is not available, the default value for the ice effective radius is used.
3. If 1) and 2) are not available, 2B-CWC ice particle effective radius and ice extinction coefficient are used. The ice cloud extinction coefficient is computed from CloudSat 2B-CWC IWC and ice particle effective radius.
4. If 1), 2), and 3) are not available, MODIS ice effective radius along with the cloud extinction coefficient are used. The MODIS cloud extinction coefficient is computed from MODIS-derived optical thickness with vertically homogeneous assumption with CALIPSO-CloudSat cloud top and base boundaries.

For the liquid-phase bin, similar steps to 2), 3), and 4) are performed using liquid-phase cloud extinction coefficient, LWC, and liquid effective radius. If the 2B-CWC liquid water cloud particle radius is out of range (less than 4 or greater than 30 microns) in steps 2 or 3, MODIS liquid particle effective radius replaces it. If the MODIS liquid particle size is not available, a default value of liquid particle effective radius (13 micron) is used. In a similar way, if the ice cloud particle diameter is out of range (less than 10 or greater than 300 microns), MODIS ice cloud effective radius or a default value of ice particle effective radius (30 micron) is used.

In step 3, CloudSat 2B-CWC IWC or LWC and cloud effective radius allow us to compute the extinction coefficient β by

$$IWC = \frac{4 \rho_I \beta r_I}{3 Q_{ext}} \quad \text{or}$$

$$LWC = \frac{4 \rho_L \beta r_L}{3 Q_{ext}}$$

where ρ_I (0.917 g cm^{-3}) and ρ_L (1 g cm^{-3}) are the density of ice and liquid cloud particles, respectively, r_I and r_L are the effective radius of ice- and liquid-phase cloud particles, respectively, and Q_{ext} is the visible extinction efficiency (extinction cross section divided by the geometrical cross section).

Once the profiles of cloud extinction coefficient and particle effective radius are constructed using steps 1–4 (steps 2–4 for liquid phase), the cloud extinction profile is normalized by MODIS information. For solar zenith angle $< 82^\circ$, column-scaled optical thickness integrated from the extinction profile is normalized by the MODIS-derived scaled optical thickness, $\tau_{MODIS}(1 - g_{MODIS}) = \alpha \sum \beta \Delta z (1 - g)$, where α is a free parameter to scale CALIPSO and CloudSat-derived scaled optical thickness by MODIS-derived scaled cloud optical thickness by

the enhanced cloud algorithm (if not available, then by the standard cloud algorithm). Where g is the asymmetry parameter, β is the extinction profile (km^{-1}). For solar zenith angle $\geq 82^\circ$, IR emission from the vertical extinction profile is normalized by the MODIS-derived IR emission term, $F_{IR}(\tau_{MODIS}, T_{MODIS}, r_{MODIS}) = \alpha F_{IR}(\beta(z), r(z))$, where r_{MODIS} is a MODIS cloud effective radius and $r(z)$ is a cloud effective radius profile from steps 1-4.

2.6.2 Aerosol Data Sources for Irradiance Computations

CALIPSO

There are sixteen aerosol layers per FOV with a top and a bottom height in km.

There are optical depths at 532 and 1064 nm for each of the 16 layers.

The horizontal averaging length in km is associated with each of the 16 layers.

MODIS

Total column AOT at multiple wavelengths.

-Ocean: 0.47, 0.55, 0.66, 0.87, 1.2, 1.6, and 2.1 microns

-Land: 0.47, 0.55, and 0.66 microns

Only if there is clear sky in the FOV.

MATCH (Model for Atmospheric Transport and Chemistry)

Daily data is on a coarse grid that is much larger than MODIS FOV size.

There are aerosol optical depths and profiles for seven types:

DustSmall (0.1 μm), DustLarge(2.5 μm), SO₄, Sea Salt, Soot, Soluble, and Insoluble

These seven types are tied to spectral (extinction, asymmetry parameter and single scatter albedo) within the CERES radiative transfer code FLCKKR. When CALIPSO detects dust layers, dust aerosols are used in the computations. Other aerosol types are determined by MATCH.

Radiative Transfer (RT) Model Use of Aerosol

The RT model accepts multiple wavelength AOT to override the spectral extinction shapes that are implicit of an aerosol type over the wavelength range given. Outside of the multi-wavelength AOT range the spectral extinction is tied to the 500 nm extinction according to the spectral extinction shape of the aerosol type.

In practice, a $\log(\text{AOT})$ vs. $\log(\text{wavelength})$ fit is done over the input wavelengths to avoid extreme slopes in the spectral extinction shape used.

The RT model accepts a profile for each aerosol type used that is the percent of aerosol AOT at 500nm within a computational layer.

The hierarchy of using aerosol properties is given by the following. Initial guess of AOTs of six aerosol types [DustSmall (0.1 μm), DustLarge (2.5 μm), SO₄, Sea Salt, Soot, Soluble, and Insoluble] are described by MATCH hourly product. If the CALIPSO-derived 532 nm AOT is

available, we use it for constraining total AOT of the six aerosol compositions. When CALIPSO detects dust aerosols, the CALIPSO dust fraction is further used to modify MATCH aerosol compositions.

If MODIS-derived AOTs available, they overwrites CALIPSO information in constraining total AOT of the six aerosol compositions. This is because MODIS AOTs are available at multiple wavelengths. MODIS ocean algorithm provides AOTs at 0.47, 0.55, 0.66, 0.87, 1.2, 1.6, and 2.1 μm , MODIS deep blue algorithm provides AOTs at 0.41, 0.47, 0.55, 0.66 μm , and MODIS land algorithm provides AOTs at 0.47, 0.55, and 0.66 μm .

The aerosol type determines the spectral shape of the optical property of aerosols. Optical properties from OPAC (Hess 1998) and A. Lacis (2004, personal communication) are used to compute single scattering albedo and the asymmetry parameter based on the MATCH-derived aerosol type, except for dust aerosols.

One aerosol extinction vertical profile (i.e. same for clear and cloudy areas) is used for a CERES footprint.

2.6.3 Temperature and Humidity Profiles for Irradiance Computations

Temperature and humidity profiles from MOA-5.4.1, which was produced from GMAO GEOS-5.4.1. Surface skin temperature derived from MODIS is used when surface skin temperature derived from MODIS with the Ed5 beta1 algorithm over the CALIPSO and CloudSat ground track is available. If the imager-derived skin temperature is not available, skin temperature from GEOS is used for the computation.

CCCM-74 Modeled aerosol type

Aerosol type used for flux computations: 1=DustSmall(0.1 μm), 2=DustLarge(2.5 μm), 3=SO₄, 4=Sea Salt, 5=Soot, 6=Soluble, and 7=Insoluble.

Values are percentage of the aerosol type contributing to the aerosol optical thickness. When values from all seven aerosol types are added, the sum is 100 with some round off error. Note, near polar regions when the MATCH-derived aerosol optical thickness is extremely small (~ 0.0001), all values can be 100, so that the sum is 7 times 100.

CCCM-75 Aerosol source flag

Source of modeled aerosol:

- 0 = MATCH (No CALIPSO, No MODIS)
- 1 = MATCH aerosol normalized to CALIPSO column AOT
- 2 = MATCH aerosol normalized to the sum of CALIPSO feature AOTs
- 3 = MATCH aerosol normalized to MOD04 MODIS deep blue algorithm @4 wavelengths
- 4 = MATCH aerosol normalized to MOD04 MODIS land algorithm @3 wavelengths
- 5 = MATCH aerosol normalized to MOD04 MODIS ocean algorithm @7 wavelengths

CALIPSO-derived optical thickness (if it is available) or MODIS-derived aerosol optical thickness (if CALIPSO optical thickness is not available) are used. If neither optical thickness is available, the aerosol optical thickness from MATCH is used. Aerosol type is either from CALIPSO (if it is available) or from MATCH.

CCCM-75a Surface albedo source

Source of the surface albedo used for computations.

0: Climatological surface albedo depending on IGBP type

1: Jin's ocean surface albedo model

2: MODIS spectral albedo

3: surface albedo history (SAH) for sea/ice

CCCM-76 Pressure profile

Atmospheric pressure at computational levels from the CERES Meteorological, Ozone, and Aerosol (MOA) analysis. It comes from GMAO GEOS-5.4.1.

CCCM-77 Temperature profile

Atmospheric temperature at computational levels from the CERES Meteorological, Ozone, and Aerosol (MOA) analysis. It comes from GMAO GEOS-5.4.1.

CCCM-78 Water vapor mixing ratio profile

Water vapor mixing ratio at computational levels from the CERES Meteorological, Ozone, and Aerosol (MOA) analysis. It comes from GMAO GEOS-5.4.1.

CCCM-79 Ozone mixing ratio profile

Ozone mixing ratio at computational levels from the CERES Meteorological, Ozone, and Aerosol (MOA) analysis. It comes from GMAO GEOS-5.4.1.

CCCM-80 Surface geopotential height

Height of the surface above sea level in geopotential meters derived from GMAO GEOS-5.4.1.

CCCM-81 Lifting condensation level

Lifting condensation level computed from thermodynamic variables from the CERES Meteorological, Ozone, Aerosol (MOA) analysis. It comes from GMAO GEOS-5.4.1.

CCCM-81a Cloud area untuned

Percent cloud cover derived from MODIS radiances by the standard CERES-MODIS cloud mask.

CCCM-81b Cloud area enhanced

Percent cloud cover derived from MODIS radiances by the enhanced cloud mask.

CCCM-81c Cloud optical depth weight untuned

FOV-mean (weighted by pixel-level frequency of occurrence) cloud optical depth derived from MODIS radiances by the standard cloud algorithm. Averaging method is log(τ).

CCCM-81d Cloud optical depth weight enhanced

FOV-mean (weighted by pixel-level frequency of occurrence) cloud optical depth derived from MODIS radiances by the enhanced cloud algorithm. Averaging method is $\log(\tau)$.

CCCM-82 Aerosol extinction coefficient profile used

Aerosol extinction coefficient (at 550 nm) vertical profile used for flux computations in both clear-sky and all-sky conditions.

CCCM-83 Aerosol single scattering albedo profile used

Aerosol single scattering albedo (at 550 nm) vertical profile used for flux computations.

CCCM-84a Cloud ice extinction coefficient profile used

Ice-phase cloud extinction coefficient (at the 600 to 700 nm band) used for flux computations from 16 cloud groups averaged by weighting by their cloud fraction.

CCCM-84b Cloud liquid extinction coefficient profile used

Liquid-phase cloud extinction coefficient (at the 600 to 700 nm band) used for flux computations from 16 cloud groups averaged by weighting by their cloud fraction.

Therefore, total cloud extinction coefficient = $\text{CCCM-84a} + \text{CCCM-84b}$ [km^{-1}].

CCCM-85 Liquid water content profile used

Liquid water content [mg m^{-3}] vertical profile used for flux computations. The profile is an average profile for the cloudy part of the CERES footprint. The profiles for up to 16 cloud groups are averaged weighted by their cloud fraction.

CCCM-86 Ice water content profile used

Ice water content [mg m^{-3}] vertical profile used for flux computations. The profile is an average profile for the cloudy part of the CERES footprint. The profiles for up to 16 cloud groups are averaged by their cloud fraction.

Ice effective radius used for flux computations [μm] = $3/4/0.917 \text{ g cm}^{-3} \times 2 \times \text{CCCM-86} / (\text{CCCM-84a}) \times 1000$

Liquid effective radius used for flux computations [μm]
= $3/4/1 \text{ g cm}^{-3} \times 2 \times \text{CCCM-85} / (\text{CCCM-84b}) \times 1000$

2.7 Vertical Irradiance Profile

Fluxes are computed for each cloud group and cloud-less columns separately and are averaged, weighted by their respective area coverage. All flux profiles have four components that are computed with 1) clouds and aerosols, 2) clouds only 3) clear-sky with aerosols, and 4) clear-sky with no aerosol.

Important note for Window flux and radiance: Modeled window (800 – 1250 cm^{-1}) irradiance profiles (CCCM-91,92,100-102) have a different spectral band than the CERES window channel. The CERES-emulated window radiance and irradiance are kept only for TOA (CCCM-111-113, 115-117).

The following CCCM SDSs (87 through 92) contain flux profiles at 134 levels (+ up to 4 levels below MSL if the altitude of the surface is below MSL).

CCCM-87 SW downward flux profile enhanced MODIS (CALIPSO CloudSat)

Shortwave downward irradiance profile at 134+4 levels computed with MODIS-derived cloud properties from the enhanced CERES cloud algorithm applied to the MODIS pixels along the CALIPSO and CloudSat ground track.

CCCM-88 SW upward flux profile enhanced MODIS (CALIPSO CloudSat)

Shortwave upward irradiance profile at 134+4 levels computed with MODIS-derived cloud properties from the enhanced CERES cloud algorithm applied to the MODIS pixels along the CALIPSO and CloudSat ground track. The MODIS spectral albedo over land and Jin's ocean and snow spectral albedos are used.

CCCM-89 LW downward flux profile enhanced MODIS (CALIPSO CloudSat)

CCCM-90 LW upward flux profile enhanced MODIS (CALIPSO CloudSat)

Longwave irradiance profiles at 134+4 levels are computed in the same way that the shortwave irradiances (CCCM-87, 88) are computed.

CCCM-91 WN downward flux profile enhanced MODIS (CALIPSO CloudSat)

CCCM-92 WN upward flux profile enhanced MODIS (CALIPSO CloudSat)

Window channel irradiance profiles at 134+4 levels are computed in the way that shortwave irradiances (CCCM-87, 88) are computed.

The following CCCM SDSs (93 through 102) only contain TOA and surface fluxes.

CCCM-93 SW downward flux TOA standard MODIS (CALIPSO CloudSat)

CCCM-94 SW upward flux TOA standard MODIS (CALIPSO CloudSat)

CCCM-95 SW downward flux surface standard MODIS (CALIPSO CloudSat)

CCCM-96 SW upward flux surface standard MODIS (CALIPSO CloudSat)

Shortwave upward and downward irradiances at TOA and surface computed with MODIS cloud properties derived by the standard CERES cloud algorithm applied to the MODIS pixels along the CALIPSO and CloudSat ground track.

CCCM-97 LW downward flux surface standard MODIS (CALIPSO CloudSat)

CCCM-98 LW upward flux TOA standard MODIS (CALIPSO CloudSat)

CCCM-99 LW upward flux surface standard MODIS (CALIPSO CloudSat)

Longwave upward and downward irradiances at TOA and surface computed with MODIS cloud properties derived by the standard CERES cloud algorithm applied to the MODIS pixels along the CALIPSO and CloudSat ground track.

CCCM-100 WN downward flux surface standard MODIS (CALIPSO CloudSat)

CCCM-101 WN upward flux TOA standard MODIS (CALIPSO CloudSat)

CCCM-102 WN upward flux surface standard MODIS (CALIPSO CloudSat)

Window channel upward and downward irradiances at TOA and surface computed with MODIS cloud properties derived by the standard CERES cloud algorithm applied to the MODIS pixels along the CALIPSO and CloudSat ground track.

- CCCM-103 SW all-sky up TOA spectral flux enh MODIS (CALIPSO CloudSat)**
CCCM-104 SW all-sky down TOA spectral flux enh MODIS (CALIPSO CloudSat)
CCCM-105 SW all-sky up surface spectral flux enh MODIS (CALIPSO CloudSat)
CCCM-106 SW all-sky down surface spectral flux enh MODIS (CALIPSO CldSat)

Shortwave all-sky upward and downward spectral irradiances at TOA and surface computed with MODIS-derived cloud properties from the enhanced CERES cloud algorithm applied to the MODIS pixels along the CALIPSO and CloudSat ground track. Wavelength information is given by CCCM-127. The sum of the irradiances over wavelength should equal the TOA or surface all-sky irradiances from CCCM-87 and CCCM-88.

- CCCM-107 LW all-sky up TOA spectral flux enh MODIS (CALIPSO CloudSat)**
CCCM-108 LW all-sky up surface spectral flux enh MODIS (CALIPSO CldSat)
CCCM-109 LW all-sky down surface spectral flux enh MODIS (CALIPSO CldSat)

Longwave all-sky upward and downward spectral irradiances at TOA and surface computed with MODIS-derived cloud properties from the enhanced CERES cloud algorithm applied to the MODIS pixels along the CALIPSO and CloudSat ground track. Wavelength information is given by CCCM-128. The sum of the irradiances over wavelength should equal the TOA or surface all-sky irradiances from CCCM-89 and CCCM-90.

- CCCM-110 LW TOA modeled unfiltered radiance enhanced (CALIPSO CloudSat)**
 Longwave upward unfiltered radiance at TOA computed with MODIS-derived cloud properties from the enhanced CERES cloud algorithm applied to the MODIS pixels along the CALIPSO and CloudSat ground track. The modeled radiance should be compared with the CERES LW unfiltered radiance (SSF-36).

- CCCM-111 WN TOA modeled unfiltered radiance enhanced (CALIPSO CloudSat)**
 Window channel upward unfiltered radiance at TOA computed with MODIS-derived cloud properties from the enhanced CERES cloud algorithm applied to the MODIS pixels along the CALIPSO and CloudSat ground track. The modeled radiance should be compared with the CERES WN unfiltered radiance (SSF-37).

- CCCM-112 WN TOA modeled filtered radiance enhanced (CALIPSO CloudSat)**
 Window channel upward filtered radiance at TOA computed with MODIS-derived cloud properties from the enhanced CERES cloud algorithm applied to the MODIS pixels along the CALIPSO and CloudSat ground track. The modeled radiance should be compared with the CERES WN filtered radiance (SSF-33).

- CCCM-113 WN TOA upward flux enhanced (CALIPSO CloudSat)**
 Window channel upward flux at TOA for which the spectral range matches that of the CERES window channel. The flux is computed with MODIS-derived cloud properties from the

enhanced CERES cloud algorithm applied to the MODIS pixels along the CALIPSO and CloudSat ground track.

CCCM-114 LW TOA modeled unfiltered radiance standard (CALIPSO CloudSat)

Longwave upward unfiltered radiance at TOA computed with MODIS-derived cloud properties from the standard CERES cloud algorithm applied to the MODIS pixels along the CALIPSO and CloudSat ground track. The modeled radiance should be compared with the CERES LW unfiltered radiance (SSF-36).

CCCM-115 WN TOA modeled unfiltered radiance standard (CALIPSO CloudSat)

Window channel upward unfiltered radiance at TOA computed with MODIS-derived cloud properties from the standard CERES cloud algorithm applied to the MODIS pixels along the CALIPSO and CloudSat ground track. The modeled radiance should be compared with the CERES WN unfiltered radiance (SSF-37).

CCCM-116 WN TOA modeled filtered radiance standard (CALIPSO CloudSat)

Window channel upward filtered radiance at TOA computed with MODIS-derived cloud properties from the standard CERES cloud algorithm applied to the MODIS pixels along the CALIPSO and CloudSat ground track. The modeled radiance should be compared with the CERES WN filtered radiance (SSF-33).

CCCM-117 WN TOA upward flux standard (CALIPSO CloudSat)

Window channel upward flux at TOA for which the spectral range matches that of the CERES window channel. The flux is computed with MODIS-derived cloud properties from the standard CERES cloud algorithm applied to the MODIS pixels along the CALIPSO and CloudSat ground track.

CCCM-118a Cloud extinction normalization flag

This flag includes the information about which normalization method used for standard (y_1) and enhanced (y_2) algorithms. The variable is reported as y , combining y_1 and y_2 :

$$\text{CCCM-118a} = y = y_1 + 100 y_2$$

The value of y_1 or y_2 is defined from the ternary scale (base 3), consisting of three digits:

$$y_1 = \text{ABC}_{(3)} = A \times 3^2 + B \times 3 + C$$

A: Visible reflectance normalization flag whether a scaled cloud optical depth ($g(1-\tau)$) is used for normalizing a merged cloud extinction profile. 0=default, 1=succeed, 2=failed

B: IR emittance normalization flag whether a MODIS cloud effective temperature is used for normalizing a merged cloud extinction profile. 0=default, 1=succeed, 2=failed

C: The flag whether a desperate option is used at least one of 16 cloud groups in a given FOV. The desperate option is when CALIPSO, CloudSat, or climatological values are used to assign MODIS-like cloud optical depth. 0=default, 1=desperate option used

For example, if $y_1 = 100_{(3)} = 9_{(10)}$, it means that the MODIS scaled cloud optical depth is successfully used for normalizing the cloud extinction profile for the standard algorithm.

CCCM-118b Irradiance modeling source flag

The flag indicates information of cloud data source (y_{cloud}), aerosol type source (y_{atype}), aerosol profile source (y_{aprof}), and AOT source (y_{aot}) as

$$\text{CCCM-118b} = y_{\text{cloud}} \times 1000 + y_{\text{atype}} \times 100 + y_{\text{aprof}} \times 10 + y_{\text{aot}}$$

In other words, the five DIGITS include following information

[Ten thousand & Thousands: Hundreds: Tens: Ones]
[CLOUD: AOTTYPE: APROFILE: AOT]

CLOUD Data Source (y_{cloud}) (provided as two digits in ten thousands and thousands) is defined from the binary system:

$$y_{\text{cloud}} = ABCDE_{(2)} = A \times 2^4 + B \times 2^3 + C \times 2^2 + D \times 2^1 + E$$

- A: SSF cloud properties (0=not used, 1=used)
- B: CALIPSO cloud properties (0=not used, 1=used)
- C: CloudSat 2B-CWC liquid properties (0=not used, 1=used)
- D: CloudSat 2B-CWC ice properties (0=not used, 1=used)
- E: CloudSat 2C-ICE ice properties (0=not used, 1=used)

For example,

- $y_{\text{cloud}} = 16_{(10)} = 10000_{(2)}$; SSF cloud properties are used
- $y_{\text{cloud}} = 12_{(10)} = 01100_{(2)}$; CALIPSO and 2B-CWC liquid properties are used
- $y_{\text{cloud}} = 5_{(10)} = 00101_{(2)}$; CloudSat 2B-CWC liquid and CloudSat 2C-ICE ice properties are used
- $y_{\text{cloud}} = 14_{(10)} = 01110_{(2)}$; CALIPSO, CloudSat 2B-CWC liquid/ice properties are used

Aerosol type Source (provided in hundreds digit; y_{atype})

- $y_{\text{atype}} = 0$; MATCH constituent TYPES: DustSm, DustLg, SO₄, SeaSalt, Soot, Soluble, Insoluble
- $y_{\text{atype}} = 1$; CALIPSO (dust and polluted dust)

Aerosol PROFILE Source (provided in tens digit; y_{aprof})

- $y_{\text{aprof}} = 0$; MATCH PROFILE: No CALIPSO layer bounds and no CALIPSO extinction are used.
- $y_{\text{aprof}} = 1$; CALIPSO-derived aerosol layer bounds exist, but no CALIPSO extinction is available.
- $y_{\text{aprof}} = 2$; Both CALIPSO-derived aerosol layer bounds and extinctions are present.

For the $y_{\text{aprof}} = 1$ case:

One aerosol layer overlapping with each cloud group and one aerosol layer in the clear-sky part are used. One clear-sky aerosol layer is derived taking the highest aerosol layer top and the lowest aerosol layer base both derived from CALIPSO. The extinction coefficient is vertically constant within an aerosol layer. The aerosol optical thickness is derived from either MODIS or MATCH.

For the $y_{\text{aprof}} = 2$ case:

The number of aerosol layers treated in this case is the same as 10 case above: one overlapping aerosol layer with each cloud group and one aerosol layer in the clear-sky part. The vertical extinction coefficient profile for each layer is derived from the CALIPSO-derived extinction coefficient. Vertical extinction profiles of dust (dust and polluted dust identified by CALIPSO) aerosols and non-dust aerosols are treated separately. If both dust and non-dust aerosols are present, two vertical profiles are used. For both profiles, when multiple extinction coefficients for a given height are available, they are averaged, weighted by the horizontal averaging length given by CALIPSO. The total aerosol optical thickness (sum of all the overlapping aerosol layers) is normalized by the integrated value of the CALIPSO-derived extinction coefficient. Note that 20 cases become 10 cases when there is no clear-sky over the ground track of CALIPSO/CloudSat available because CCCM-49 (mean CALIPSO 532 nm aerosol optical thickness over clear-area) is used in 20 cases.

Aerosol OPTICAL DEPTH Source (provided in ones digit; y_{aot}): Identical to CCCM-75

$y_{\text{aot}} = 0$; MATCH (No CALIPSO, No MODIS)

$y_{\text{aot}} = 1$; MATCH aerosol normalized to CALIPSO column AOT

$y_{\text{aot}} = 2$; MATCH aerosol normalized to the sum of CALIPSO feature AOTs

$y_{\text{aot}} = 3$; MATCH aerosol normalized to MOD04 MODIS deep blue algorithm @4 wavelengths

$y_{\text{aot}} = 4$; MATCH aerosol normalized to MOD04 MODIS land algorithm @3 wavelengths

$y_{\text{aot}} = 5$; MATCH aerosol normalized to MOD04 MODIS ocean algorithm @7 wavelengths

CCCM-119 Flux confidence flag

This flag should be zero to indicate a valid model computation. There are two values given for each FOV: the first for the “standard” computation and the second for the “enhanced” computation.

CCCM-120 Irradiance surface level

Index of the surface height found in the irradiance level height profile (CCCM-124) used for the irradiance computation.

2.8 Vertical Height Profile

CCCM-121 Layer center height profile (clouds and aerosol)

The layer center height for the layer mean cloud properties derived from CloudSat (found in CCCM-51, -52, and -61 through -72).

CCCM-122 Level height profile (clouds and aerosol)

The edge height of the layers in CCCM-121.

CCCM-123 Irradiance layer center height profile

The layer center height for the model input profiles from CCCM-82 through CCCM-86.

CCCM-124 Irradiance level height profile

The edge height of the layers in CCCM-123 for which the irradiance profiles are computed (CCCM-87 through CCCM-92) and for the atmospheric input profiles (CCCM-76 through CCCM-79).

CCCM-125 CALIPSO cloud layer center height profile

The layer center height for the CALIPSO layer products from CCCM-53 through CCCM-60.

CCCM-126 CALIPSO cloud level height profile

The edge height of the layers in CCCM-125.

CCCM-127 Shortwave spectral wave number bounds

The edges of the shortwave spectral bands used for the irradiance computations.

CCCM-128 Longwave spectral wave number bounds

The edges of the longwave spectral bands used for the irradiance computations.

3.0 SSF Variable Descriptions

The variable descriptions for many of the SSF variables can be obtained from the SSF Collection Guide at http://ceres.larc.nasa.gov/documents/collect_guide/pdf/SSF_CG_R2V1.pdf.

This section describes **additional** SSF variables that are not yet documented in the SSF Collection Guide; these variables are listed in subsections that correspond to the Vgroup names in the CCCM HDF file. Also, some Ed2 SSF variables are eliminated in the Ed4 SSF product and are not included in the CCCM product.

3.1 Scene Type Definitions

SSF-29 Cloud Classification

This parameter contains a cloud classification based on surface type, number of cloud layers, cloud fraction, effective pressure, and optical depth.

The five digits, from right to left, correspond to a one digit surface code as determined in [Table 3-1](#), a two-digit upper cloud layer code as determined from [Table 3-2](#), and a two-digit lower cloud layer code as determined from [Table 3-2](#). If either cloud layer is not present, 00 is used for the code. (N/A) [0..27279)

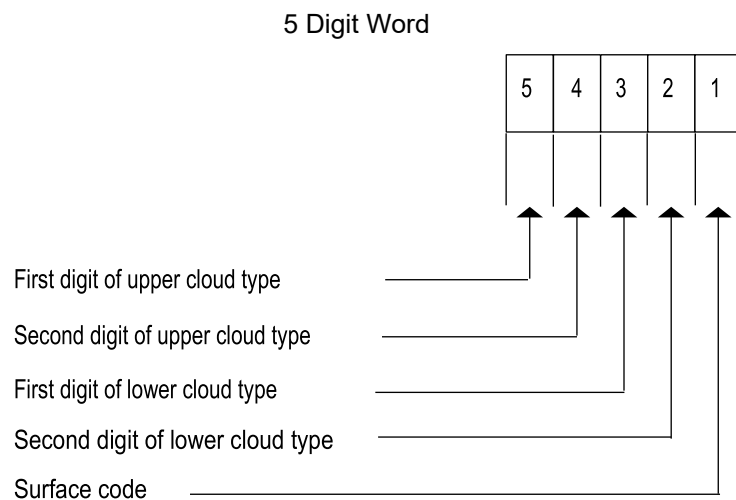

Figure 3-1. Cloud classification.

The surface code is derived from the ADM type using SW if available otherwise LW is used (see SSF-27 or SSF-28) and then further refined for land using the surface type index (see SSF-25). If a given surface code does not provide complete coverage, the surface code with the highest coverage is used.

Table 3-1. Surface Code Definition

Surface Code	Surface Name	ADM Type Range	Surface Type Index
1	Water	0-99; 400-499	Water (17)
2	Forest	100-199	Evergreen Needleleaf Forest(1); Evergreen Broadleaf Forest(2); Deciduous Needleleaf Forest(3); Deciduous Broadleaf Forest(4); Mixed Forest (5)
3	Savanna	100-199	Woody Savannas (8); Savannas (9)
4	Grassland/Cropland	100-199	Closed Shrublands (6); Grasslands (10); Permanent Wetlands (11); Croplands (12); Urban and Built-up (13); Cropland Mossaics (14)
5	Open Shrub	100-199	Open Shrublands (7); Tundra (18)
6	Barren Desert	100-199	Bare Soil and Rocks (16)
7	Permanent Snow	200-299; 600-699	Snow and Ice (permanent) (15)
8	Fresh Snow	200-299; 600-699	Fresh Snow (19)
9	Sea Ice	200-299; 600-699	Sea Ice (20)

The available cloud codes are the same for the lower and upper layer. They are based on cloud fraction, effective pressure, and optical thickness. A zero is used if a cloud layer is not present.

Table 3-2. Cloud Layer Code Definition

Effective Pressure (hPa)	Partly Cloudy (0.1 - 40%)			Mostly Cloudy (40 – 99%)			Overcast (99 – 100%)		
	Thin	Moderate	Thick	Thin	Moderate	Thick	Thin	Moderate	Thick
High (< 440 hPa)	19	20	21	22	23	24	25	26	27
Middle (440 > p > 680 hPa)	10	11	12	13	14	15	16	17	18
Low (> 680 hPa)	01	02	03	04	05	06	07	08	09

SSF-30 Snow/Ice percent coverage clear-sky overhead-sun vis albedo

This parameter is the PSF-weighted percent of snow/ice within the CERES FOV. The percent coverage is reported as an integer. A thousand (1000) is added to the value if the FOV is within 50 km of a coast. This snow/ice coverage is different from the snow and ice surface types discussed in SSF-25 and the cloud-mask snow/ice percent coverage discussed in SSF-69. This snow/ice percent coverage is based upon the MODIS Clear-sky overhead-sun albedo history maps (using 0.6 micron) that is part of the process in determining the CERES cloud mask and properties. Every two days, the albedo maps are updated. For each 10-minute grid box over the polar region, if the overhead-sun albedo is greater than a given threshold, it is then flagged as

covered by snow/ice. Here polar region includes 60 degree poleward, any snow/ice covered regions between 50° and 60° N(S), and any permanent snow regions. This pixel level snow/ice information weighted with point spread function. This calculation is done only when more than half of the pixels within the FOV have valid snow/ice information, otherwise it is set as default.

3.2 CERES-derived TOA and Surface Irradiances (Vgroup: TOA and Surface Fluxes)

SSF-38 CERES SW TOA flux – upwards

This parameter is an estimate of the instantaneous reflected solar flux from the Earth-atmosphere at the colatitude and longitude position of the CERES footprint. (Note that colatitude and longitude are defined at the surface.) The TOA flux is obtained by applying the CERES angular distribution models to the CERES shortwave radiance. The scene I.D. is based on MODIS-derived cloud properties over the entire CERES footprint by the revised CERES-MODIS cloud algorithm.

SSF-38a TOA Incoming Solar Radiation

TOA Incoming Solar Radiation computed with the solar zenith angle at the surface for the location and time of the CERES radiance observation.

SSF-39 CERES LW TOA flux – upwards

This parameter is an estimate of the instantaneous thermal flux emitted from the Earth-atmosphere at the colatitude and longitude position of the CERES footprint. (Note that colatitude and longitude are defined at the surface.) The TOA flux is obtained by applying the CERES angular distribution models to the CERES longwave radiance.

SSF-40 CERES WN TOA flux – upwards

This parameter is an estimate of the instantaneous thermal flux emitted in the 8.0 to 12.0 μm window from the Earth-atmosphere at the colatitude and longitude position of the CERES footprint. (Note that colatitude and longitude are defined at the surface.) The TOA flux is obtained by applying the CERES angular distribution models to the CERES window radiance.

SSF-40a CERES SW Anisotropic Factor

The SW anisotropic factor at nadir and the CERES view zenith angle.

SSF-46a CERES downward SW surface flux - Model B, clearsky

This parameter is the estimated clear-sky downward shortwave flux at the surface based on the Langley Parameterized Shortwave Algorithm (LPSA). The downward Model B flux is based on the LPSA net with LPSA surface albedo models.

SSF-47a CERES downward LW surface flux - Model B, clearsky

This parameter is the estimated clear-sky downward longwave flux at the surface based on the Langley Parameterized Longwave Algorithm (LPLA).

SSF-49a CERES downward LW surface flux - Model C

This parameter is the estimated downward longwave flux at the surface based on the Zhou-Cess model.

SSF-49b CERES downward LW surface flux - Model C, clearsky

This parameter is the estimated downward longwave flux at the surface based on the Zhou-Cess model.

SSF-49c CERES net LW surface flux - Model C

This parameter is the estimated net shortwave flux at the surface based on the Zhou-Cess model. Net flux is defined as downwelling flux minus upwelling flux.

3.3 Full Footprint Area Definitions**SSF-59a Surface pressure**

This parameter is the MOA surface pressure. The surface pressure value is obtained from the one-degree equal-angle MOA region containing the colatitude and longitude of CERES FOV at the surface. A linear interpolation in the temporal domain produces the hourly MOA values from the six-hourly input data samples.

SSF-59b Constrained near-surface air temperature for DLF calculations

This parameter is a correction to the near-surface air temperature used in the downward longwave surface flux model calculation.

SSF-60a Surface minus 750 mb air temperature difference

This parameter is computed by subtracting the air temperature at the pressure level 750 hPa from the surface temperature obtained from MOA.

SSF-60b Estimated Inversion Stability

This parameter is the Estimated Inversion Stability as given by Robert Wood and Christopher S. Bretherton, Journal of Climate, Volume 19, Issue 24 (December 2006) pp. 6425-6432 DOI: 10.1175/JCLI3988.1. It is based on the Lower Tropospheric Stability, potential temperature difference between 700 mb and the surface reduced by the moist adiabatic lapse rate times the height between the 700 mb potential height and the Lifted Condensation Level (LCL).

SSF-60c 750 mb minus surface air potential temperature difference

This parameter is computed by subtracting the surface air potential temperature from the air potential temperature at the pressure level 750 hPa obtained from reanalysis.

SSF-65a Additional notes on cloud algorithms

This parameter is a collection of cloud parameters which are defined by single digits. The five digits, from right to left, correspond to reserved, reserved, use of CO2 SIST (see SSF-65a-C), mixed-phase clouds (see SSF-65a-D), and polar pixels (see SSF-65a-E). All are referenced to the full FOV, and most are derived from pixel level flags set by the cloud retrieval. (N/A) [0 .. 32766]

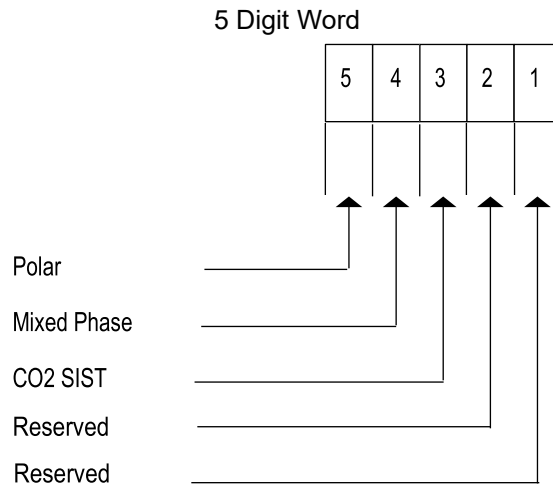

Figure 3-2. Additional notes on cloud algorithms.

SSF-65a-A Reserved

Digit is set to 0.

SSF-65a-B Reserved

Digit is set to 0.

SSF-65a-C CO2 SIST

CO2 SIST indicates what percentage range of the full FOV contains cloudy imager pixels for which the CO2 slicing algorithm was used to make the cloud determination. Alternately stated, this digit represents the CO2 slicing coverage normalized by the imager percent coverage area. CO2 SIST coverage is computed and recorded as

$$f_k^i = \frac{n_k^i}{n^i}$$

$$\text{Percent Coverage} = \left(\frac{\sum_{S_i} \omega_i f_k^i}{\sum_{S_i} \omega_i} \right) \times 100$$

where:

n^i is the number of pixels in angular bin i

n_k^i is the number of pixels identified as CO2 SIST cloud ($k=3$) or mixed phase ($k=4$)

ω_i is the integral of the PSF over bin i

S_i is the set of indices for clear/cloudy observed bins

SSF-65a-D Mixed Phase

Mixed phase indicates what percentage range of the full FOV contains cloudy imager for which contain both water droplets and ice crystals. Alternately stated, this digit represents the mixed phase cloud coverage normalized by the imager percent coverage area.

Mixed phase coverage is computed and recorded similar to CO2 SIST above (see SSF-65a-C).

SSF-65a-E Polar

Polar is set to 2 to indicate that the FOV contains all imager pixels within the polar region. If there is a mixture of polar and nonpolar imager pixel, it is set to 1. Otherwise, polar is set to 0. Here polar region includes 60 degree poleward, any snow/ice covered regions between 50° and 60° N(S), and any permanent snow regions.

SSF-65b Notes on cloud multilayer

This parameter is a collection of cloud parameters which are defined by single digits. The five digits, from right to left, correspond to reserved, reserved, the multilayer algorithm did not reach a solution (see SSF-65b-C), the upper level cloud was too thick to determine a lower layer (see SSF-65b-D), and reserved. All are referenced to the full FOV, and most are derived from pixel level flags set by Cloud retrieval. (N/A) [0 .. 32766]

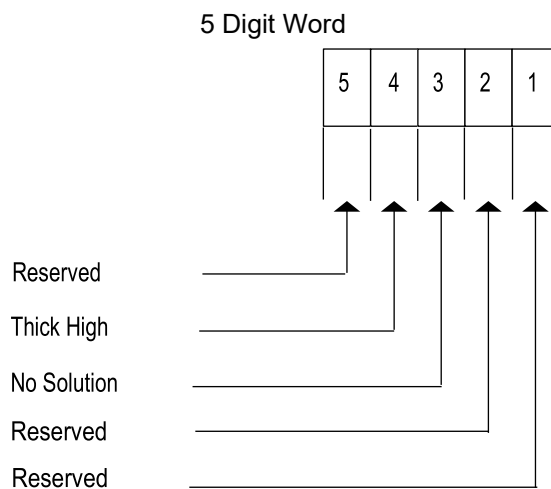

Figure 3-3. Notes on cloud multilayer.

SSF-65b-A Reserved

Digit is set to 0.

SSF-65b-B Reserved

Digit is set to 0.

SSF-65b-C No Solution

No Solution indicates what percentage range of the full FOV contains cloudy imager pixels for which the multilayer algorithm could not make a determination. Alternately stated, this digit represents the no solution multilayer algorithm coverage normalized by the imager percent coverage area no solution coverage is computed and recorded as

$$f_k^i = \frac{n_k^i}{n^i}$$

$$\text{Percent Coverage} = \left(\frac{\sum_{S_i} \omega_i f_k^i}{\sum_{S_i} \omega_i} \right) \times 100$$

where:

n^i is the number of pixels in angular bin i

n_k^i is the number of pixels identified as no solution from the multilayer algorithm ($k=3$) or thick high cloud ($k=4$)

ω_i is the integral of the PSF over bin i

S_i is the set of indices for clear/cloudy observed bins

SSF-65b-D Thick High

Thick high indicates what percentage range of the full FOV contains cloudy imager for which a high cloud was too thick to allow a determination of the lower layer cloud.

Alternately stated, this digit represents the thick high cloud coverage normalized by the imager percent coverage area.

Thick high coverage is computed and recorded similar to no solution above (see SSF-65b-C).

SSF-65b-E Reserved

Digit is set to 0.

3.4 Clear Footprint Area Definitions

SSF-79a CWG precipitable water

This parameter is the column water vapor amount in cm or, equivalently, g/cm^2 after adjustments during the cloud retrieval algorithm.

3.5 Cloudy Footprint Area Definitions

SSF-94a Mean cloud top temperature for cloud layer

This parameter is a PSF-weighted mean of the cloud top temperature values associated with imager pixels that fall within the current CERES FOV and have a cloud at the corresponding height layer.

SSF-94b Mean cloud top height for cloud layer

This parameter is a PSF-weighted mean of the cloud top height values associated with imager pixels that fall within the current CERES FOV and have a cloud at the corresponding height layer.

SSF-102 Mean cloud base height for cloud layer

This parameter is a PSF-weighted mean of the cloud base height values associated with imager pixels that fall within the current CERES FOV and have a cloud at the corresponding height layer.

SSF-102a Mean cloud base temperature for cloud layer

This parameter is a PSF-weighted mean of the cloud base temperature values associated with imager pixels that fall within the current CERES FOV and have a cloud at the corresponding height layer.

SSF-105 Mean ice particle gen effective radius for cloud layer (3.7)

This parameter is a PSF-weighted mean of the generalized effective particle radius values based on the 0.6/3.7 μm retrieval. It is associated with imager pixels that fall within the current CERES FOV and have a cloud with ice particle phase at the corresponding height layer.

SSF-108 Mean water particle radius for cloud layer (1.2)

This parameter is a PSF-weighted mean of bin-averaged spherical water droplet model particle radius values based on the 0.6/1.24 μm retrieval. It is associated with the imager pixels that fall within the current CERES FOV and have a cloud with water particle phase at the corresponding height layer.

SSF-109 Mean ice particle gen effective radius for cloud layer (1.2)

This parameter is a PSF-weighted mean of the generalized effective particle radius values based on the 0.6/1.24 μm retrieval. It is associated with imager pixels that fall within the current CERES FOV and have a cloud with ice particle phase at the corresponding height layer.

SSF-110 Mean logarithm of visible optical depth for cloud layer (1.2)

This parameter is the PSF-weighted mean of the bin-averaged natural logarithms of the visible optical depth values based on the 0.6/1.6 μm retrieval. It is associated with imager pixels that fall within the current CERES FOV and have a cloud at the corresponding height layer.

SSF-110a Mean water particle radius for cloud layer (2.1)

This parameter is a PSF-weighted mean of bin-averaged spherical water droplet model particle radius values based on the 0.6/2.1 μm retrieval. It is associated with the imager pixels that fall within the current CERES FOV and have a cloud with water particle phase at the corresponding height layer.

SSF-110b Mean ice particle gen effective radius for cloud layer (2.1)

This parameter is a PSF-weighted mean of the generalized effective particle radius values based on the 0.6/2.1 μm retrieval. It is associated with imager pixels that fall within the current CERES FOV and have a cloud with ice particle phase at the corresponding height layer.

SSF-110c Mean logarithm of visible optical depth for cloud layer (2.1)

This parameter is the PSF-weighted mean of the bin-averaged natural logarithms of the visible optical depth values based on the 0.6/2.1 μm retrieval. It is associated with imager pixels that fall within the current CERES FOV and have a cloud at the corresponding height layer.

SSF-111 CO2 slicing percent coverages for cloud layer

The parameter is the PSF-weighted portion of the CERES FOV, at the imager resolution of the pixel that the CO2 slicing algorithm detected clouds. It is associated with imager pixels that fall within the current CERES FOV and have a cloud at the corresponding height layer. The CO2 slicing algorithm detects higher, thinner clouds than normally detected by the VISST algorithm.

SSF-111a Mean infrared emissivity for cloud layer - CO2 slicing

This parameter is the PSF-weighted mean of the infrared emittance determined using the CO2 slicing channels' values associated with imager pixels that fall within the current CERES FOV and have a cloud at the corresponding height layer.

SSF-111b Mean effective pressure for cloud layer - CO2 slicing

This parameter is the PSF-weighted mean of the effective pressure determined using the CO2 slicing channels' values associated with imager pixels that fall within the current CERES FOV and have a cloud at the corresponding height layer.

Cloud retrieval determines the pixel cloud effective pressure after obtaining the cloud effective height. A linear interpolation of the natural logarithm of pressures from the MOA profile levels that bracket the cloud effective height is performed. The logarithm of pressure is then converted back. A linear regression for each layer of the MOA profile is performed producing a slope and intercept.

SSF-111c Mean effective temperature for cloud layer - CO2 slicing

This parameter is the PSF-weighted mean of the effective temperature determined using the CO2 slicing channels' values associated with imager pixels that fall within the current CERES FOV and have a cloud at the corresponding height layer.

SSF-112 Mean effective height for cloud layer - CO2 slicing

This parameter is the PSF-weighted mean of the effective height determined using the CO2 slicing channels' values associated with imager pixels that fall within the current CERES FOV and have a cloud at the corresponding height layer.

Cloud retrieval assigns cloud effective height to each cloudy imager pixels by linearly interpolating to the calculated cloud effective temperature using the MOA profiles of temperature and height.

3.6 Multilayer Cloud Footprint Area Definitions

In the CCCM product, the cloud variables SSF-81 through SSF-113 are obtained using the revised version of the CERES clouds algorithm used in Ed2 SSF. The multilayer cloud algorithm is also applied to MODIS pixels to derive the multilayer cloud variables SSF-114a through SSF-114k, described below. An ability to relate changes in cloud coverage and variables between the revised cloud algorithm and the multilayer algorithm was implemented.

The parameters in this group describe cloud coverages and properties from the multilayer cloud algorithm (new in RelB1) for the cloudy portion of the CERES footprint. The first parameter contains coverage for each of the four sets of MODIS-derived cloud properties (indicated by the second dimension) and for each set, the four types of cloud coverage classifications (indicated by the third dimension). The remaining parameters describe cloud properties for the four sets and classifications based on the four cloud coverage classifications.

The MODIS-derived cloud property sets are:

1. Cloud and aerosol properties derived from MODIS radiances by the standard CERES cloud algorithms and averaged over the entire CERES footprint
2. Cloud and aerosol properties derived from MODIS radiances by the standard CERES cloud algorithms and averaged only along the ground track
3. Cloud and aerosol properties derived from MODIS radiances by the enhanced CERES cloud algorithms and averaged only along the ground track
4. Cloud and aerosol properties derived from MODIS radiances by the enhanced CERES cloud algorithms and averaged over the entire CERES footprint (currently filled with default values)

The four types of cloud coverage classifications are:

1. single lower cloud layer from the revised cloud algorithm that is not multilayer,
2. single upper cloud layer from the revised cloud algorithm that is not multilayer, including optically thick clouds,
3. multilayer cloud that is assigned to lower cloud layer in the revised cloud algorithm,
4. multilayer cloud that is assigned to upper cloud layer in the revised cloud algorithm.

Figure 3-4 shows a representation of how the cloud coverage is correlated between the revised cloud algorithm (SSF-81) and the new multilayer algorithm (SSF-114a). The lower layer cloud detected by the revised cloud algorithm in SSF-81 will remain a single lower layer in SSF-114a or be identified as a multilayer cloud with coverage in multilayer lower. Similarly, this process is repeated for the upper layer cloud in SSF-81, if it exists in a CERES footprint. An upper layer pixel will remain a single upper layer or be identified as a multilayer cloud with coverage in multilayer upper.

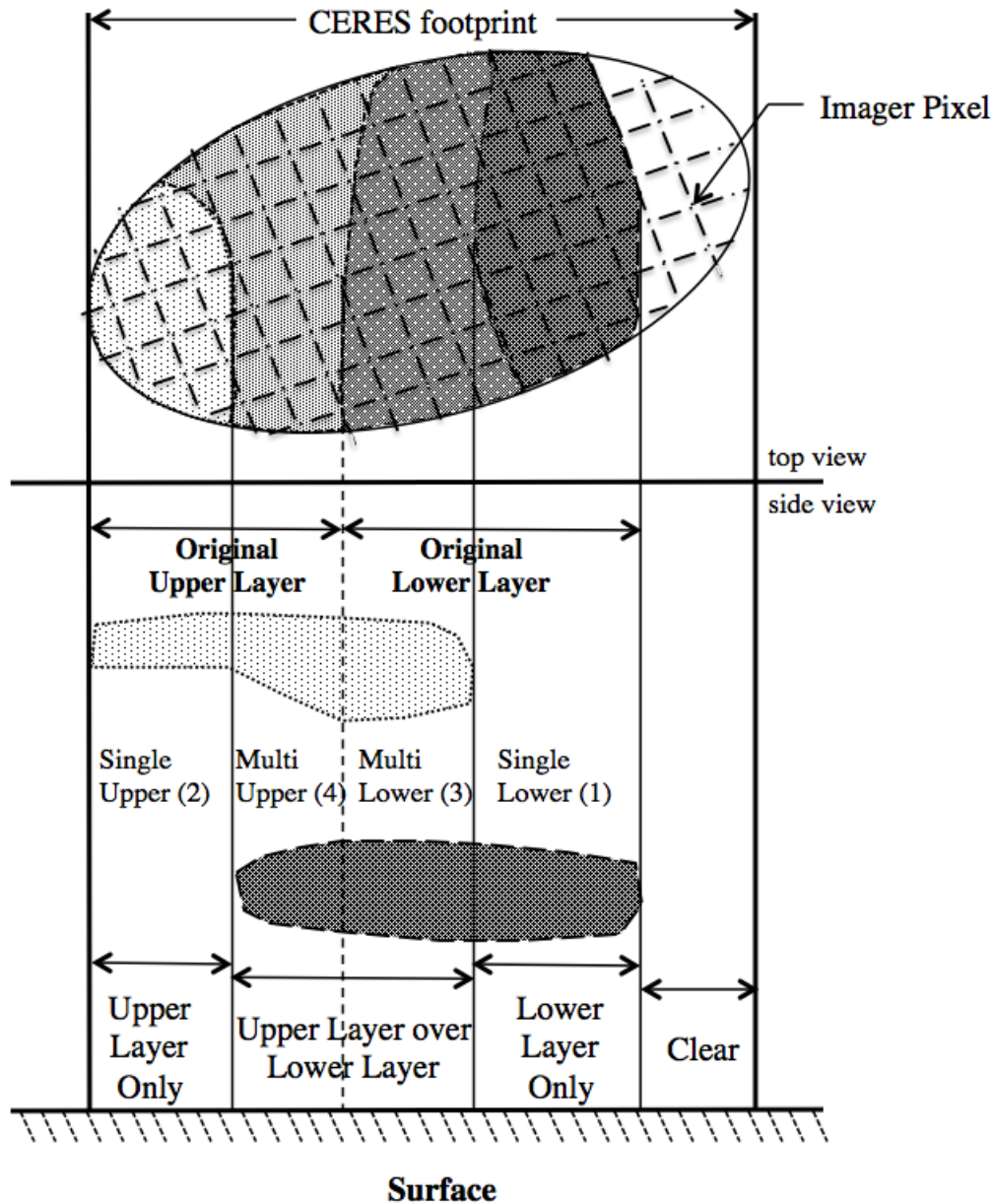

Figure 3-4. Illustration of the CERES single layer/multilayer cloud coverage classification. (1) single lower layer, (2) single upper layer, (3) lower multilayer, and (4) upper multilayer in Ed4 SSF. Note that if the revised cloud algorithm were used, the sum of (1) and (3) would be classified as a lower layer and the sum of (2) and (4) would be classified as an upper layer because cloud overlap is not treated in the revised algorithm. Clouds classified as (3) would belong to (1) if the revised algorithm were applied. Similarly clouds classified as (4) would belong to (2).

The cloud layer properties SSF-114b through SSF-114k are based on the four multilayer cloud coverage classifications in SSF-114a. The four types of cloud classifications for cloud properties are (third dimension of the property variable):

1. Cloud property from single lower cloud layer from the revised cloud algorithm that have not been reclassified as multilayer,
2. Cloud property from single upper cloud layer from the revised cloud algorithm that have not been reclassified as multilayer, including optically thick clouds,
3. Cloud property from the lower multilayer cloud layer from all pixels reclassified as multilayer (those included in the coverage of SSF-114a (3) and (4)),
4. Cloud property from the upper multilayer cloud layer from all pixels reclassified as multilayer (those included in coverage of SSF-114a (3) and (4)).

As long as there are multilayer pixel properties in a footprint, SSF-114b through k will have values for both (3) and (4) in the third dimension even though SSF-114a (3) or (4) could be zero.

We show two examples of how cloud top pressures (SSF-114e) are assigned when the multilayer cloud algorithm detects multilayer clouds. In [Figure 3-4](#), the revised cloud algorithm reports two cloud layers within a CERES footprint; therefore, the multilayer algorithm will report four cloud top pressures as described in the paragraph above. However, in [Figure 3-5](#), the revised cloud algorithm reports only one cloud layer within a footprint; therefore, a cloud top pressure will be assigned to single lower layer (1). Since there are no upper layer pixels from the revised cloud algorithm, a cloud top pressure cannot be calculated for the single upper layer classification from the multilayer algorithm, and (2) is set to default. Since some of the pixels from the lower layer of the revised cloud algorithm are actually multilayer, both (3) and (4) will have pressures assigned.

If there are no imager pixels with valid cloud layer parameter values, the multilayer cloud parameters will be set to CERES default. If a single layer area percent coverage is set to 0 or CERES default, the corresponding array value (1 for single lower, 2 for single upper) in the cloud layer parameters is set to CERES default. If both multilayer area percent coverages are set to 0 or CERES default, the corresponding array values (both 3 and 4) are set to CERES default.

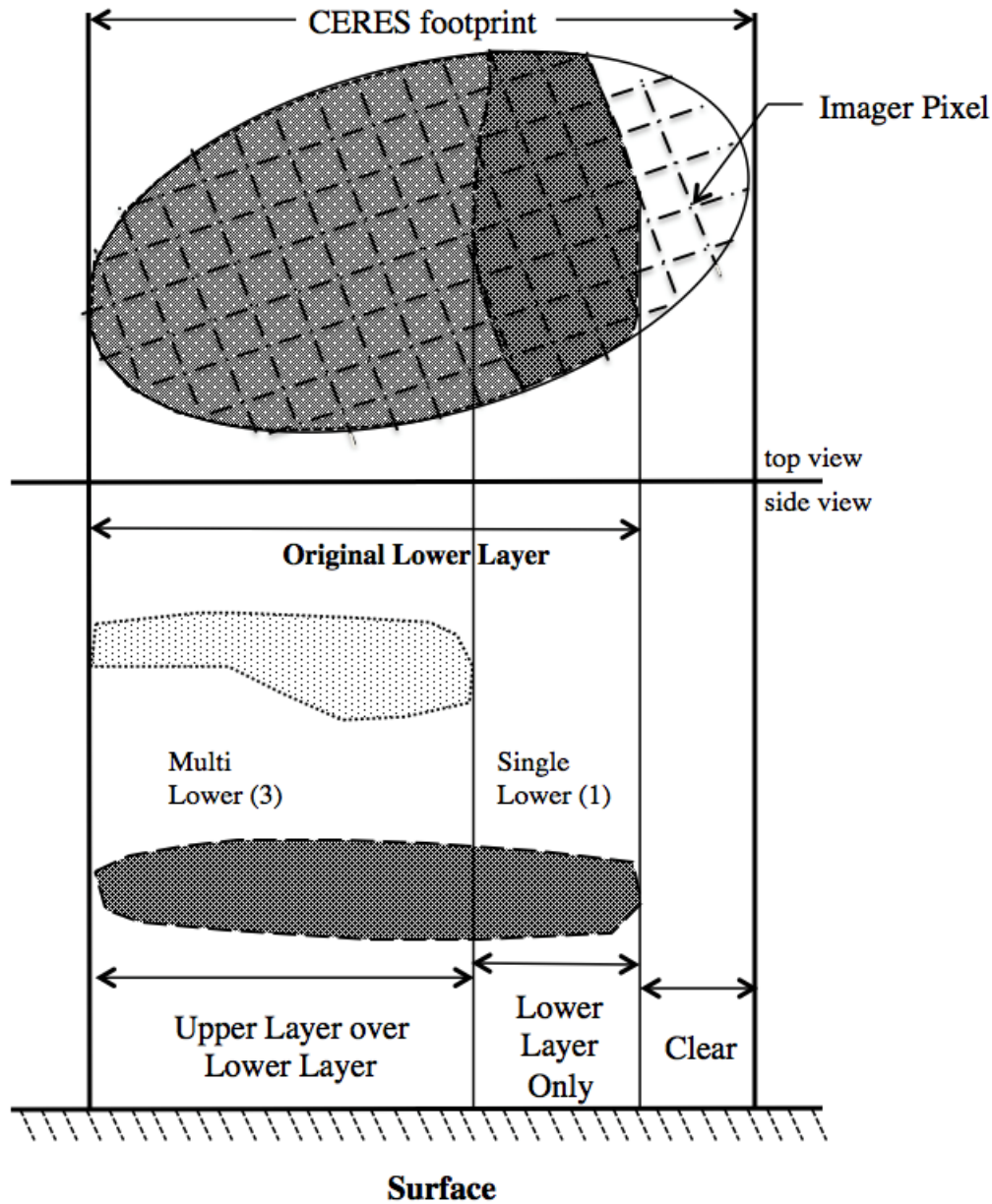

Figure 3-5. Illustration of the CERES single layer/multilayer cloud coverage classification in Ed4 SSF, but when the revised cloud algorithm had only one layer. The single layer/multilayer cloud coverage will be reported in (1) single lower layer and (3) lower multilayer. Since there was not an upper cloud in the revised algorithm, (2) single upper layer and (4) upper multilayer coverages are not present and are set to zero. In the revised algorithm, the sum of (1) and (3) would be classified as a lower layer because cloud overlap is not treated. Clouds classified as (3) would belong to (1) if the revised algorithm were applied. The revised cloud algorithm reports only one cloud layer within a footprint; therefore, a cloud layer property will be assigned to single lower layer (1). Cloud layer properties for the single upper layer (2) would be set to default because there are no upper layer pixels from the revised cloud algorithm. Since some of the pixels from the lower layer of the revised cloud algorithm are actually multilayer, both (3) and (4) will have cloud layer properties assigned.

SSF-114a Single layer/multilayer percent coverages

This parameter is the PSF-weighted portion of the CERES FOV, at the imager resolution of the pixel for up to four cloud layer combinations (See [Figure 3-4](#)). (percent) [0 .. 100]

The 4 coverages (See [Figure 3-4](#)) are:

1. Single lower layer
2. Single upper layer
3. Lower multilayer cloud
4. Upper multilayer cloud.

These four coverages are related to SSF-81 (which contains percent coverages of clear sky, lower cloud layer, upper cloud layer, and overlap) as follows. Pixels that are assigned to the lower cloud layer in SSF-81 (i.e. the second percentage of the third dimension of that variable) will either remain a single lower layer (1) or be identified as a multilayer cloud with coverage reported in multilayer lower (3), i.e. $SSF-81(2) = SSF-114a(1) + SSF-114a(3)$. In [Figure 3-4](#), note that the portion of the upper layer that extends over (3) is not detected by the revised cloud algorithm. The lower layer of the multilayer cloud (3) is detected by the revised cloud algorithm as a low cloud, but probably at a higher height than in the multilayer algorithm. Similarly, this process is repeated for the upper layer cloud in SSF-81 (i.e. the third percentage of the third dimension of the variable), if it exists in a CERES footprint. An upper layer pixel will either remain a single upper layer (2) or be identified as a multilayer cloud with coverage in multilayer upper (4), i.e. $SSF-81(3) = SSF-114a(2) + SSF-114a(4)$. In [Figure 3-4](#), note that the portion of the lower layer that extends under (4) is not detected by the revised cloud algorithm. To determine the total coverage of multilayer clouds, the coverages in (3) and (4) need to be summed. If the single layer/multilayer percent coverages (SSF-114a) for a given FOV are not set to CERES default, their sum is equal to 100 minus the clear coverage (SSF-81, the first percentage of the third dimension), plus or minus a round-off error. The percent coverages provided in SSF-114a are relative to the entire CERES footprint. To determine the percentages in each category of total cloud coverage, divide by the sum of the cloudy area (i.e. the area given by $SSF-114a(1+2+3+4)$).

There are several special cases that can occur. The first is if there is not an upper layer in SSF-81 (i.e. the third percentage of the third dimension of the variable is zero), then the single layer/multilayer percent coverage of SSF-114a(2) and SSF-114a(4) will also be zero. Additionally, if none of the pixels assigned to the lower layer cloud in SSF-81 are identified as multilayer, coverage of SSF-114a(3) will be zero. Likewise, if the upper layer cloud in SSF-81 is too thick to identify any lower clouds below it, SSF-114a(4) will be zero. Therefore, the multilayer cloud coverages of SSF-114a(3) and SSF-114a(4) usually contain different values. In the extreme case above, either SSF-114a(3) or SSF-114a(4) is zero. Another possibility is that if all pixels associated with the lower cloud layer in SSF-81 are identified as multilayer, the coverage of SSF-114a(1) will be 0. If this happens with the upper cloud layer, coverage of SSF-114a(2) will be zero. If no multilayer clouds are found, the coverages of SSF-114a(1) and SSF-114a(2) are the same as in SSF-81(2) and SSF-81(3), and SSF-114a(3) and SSF-114a(4) are zero.

There are cases where the cloud mask identifies clouds, but cloud properties cannot be assigned. If enough known cloud properties exist, the known properties are assumed to be the same for the unknown pixels. The percent of pixels for which this occurs is reported in “Cloud property extrapolation over cloudy area” (see SSF-63). However, if this percentage is too large, SSF-63, SSF-81(2-4), and SSF-114a are all set to CERES default.

SSF-114b Mean visible optical depth for multilayer

PSF-weighted mean visible optical depth derived from imager radiances that fall within the CERES FOV, over single layer and multilayer clouds. (N/A) [0 .. 400], i.e. (1) and (2) for this variable correspond to the areas of (1) and (2) in SSF-114a respectively. (3) and (4) for this variable correspond to the total area covered by multilayer clouds (sum of area (3) and (4) discussed in SSF-114a).

The optical thickness of (1) through (4) is averaged by weighting by the respective fractional coverage in addition to the PSF. This value is set to the CERES default value if one of following three cases occurs: 1) there are no imager pixels with valid optical depth values, 2) the corresponding single layer area percent coverage is zero, or 3) both multilayer area percent coverages are 0 or CERES default. This variable is always set to the CERES default value when the solar zenith angle is greater than 90 degrees.

SSF-114c Mean logarithm of visible optical depth for multilayer

PSF-weighted mean of the natural logarithm of visible optical depth derived from imager radiances that fall within the CERES FOV and over single layer and multilayer clouds. (N/A) [-6 .. 6], i.e. (1) and (2) for this variable correspond to the areas of (1) and (2) in SSF-114a respectively. (3) and (4) for this variable correspond to the total area covered by multilayer clouds (sum of area (3) and (4) discussed in SSF-114a).

The natural logarithm of optical thickness of (1) through (4) is averaged by weighting by the respective fractional coverage in addition to the PSF. This value is set to the CERES default value if one of following three cases occurs: 1) there are no imager pixels with valid optical depth values, 2) the corresponding single layer area percent coverage is zero, or 3) both multilayer area percent coverages are 0 or CERES default. This variable is always set to the CERES default value when the solar zenith angle is greater than 90 degrees.

SSF-114d Mean cloud infrared emissivity for multilayer

PSF-weighted mean cloud infrared emissivity derived from imager radiances that fall within the CERES FOV and over single layer and multilayer clouds. (N/A) [0 .. 2]], i.e. (1) and (2) for this variable correspond to the areas of (1) and (2) in SSF-114a respectively. (3) and (4) for this variable correspond to the total area covered by multilayer clouds (sum of area (3) and (4) discussed in SSF-114a).

The averaged values are weighted by the imager pixel fraction of corresponding cloud area coverage to total cloud cover in addition to PSF. If there are no imager pixels with valid cloud top pressure values or if the corresponding single layer or both multilayer area percent coverage is set to 0 or CERES default, this variable is set to CERES default. Effective emissivity is defined as the ratio of the difference between the observed and clear-sky radiance to the

difference between the cloud emission radiance and the clear-sky radiance. Both infrared scattering and emission are included in this parameter. Because scattering tends to block radiation from the warmer, lower portions of the cloud, the observed radiance can be less than cloud emission radiance (i.e., the cloud appears colder than it really is). By definition, the effective emissivity in these cases will be greater than one. This condition occurs most often for optically thick clouds at large imager viewing zenith angles, and for FOVs containing optically thick clouds that have an equivalent blackbody temperature that is within a few degrees of the clear-sky temperature.

SSF-114e Mean cloud top pressure for multilayer

PSF-weighted mean top pressure derived from imager radiances that fall within the CERES FOV and over single layer and multilayer clouds. (hPa) [0 .. 1100]], i.e. (1) and (2) for this variable correspond to the areas of (1) and (2) in SSF-114a respectively. (3) and (4) for this variable correspond to the total area covered by multilayer clouds (sum of area (3) and (4) discussed in SSF-114a).

The averaged values are weighted by the imager pixel fraction of corresponding cloud area coverage to total cloud cover in addition to PSF.

The derived cloud phase, effective cloud temperature, and the cloud emissivity are used in a set of empirical formulae to compute the cloud top emissivity and physical cloud top height. This cloud-top emissivity is used to compute an estimate of cloud-top radiance using the clear-sky and observed radiances. Cloud-top radiance is converted to cloud-top brightness temperature. The temperature and height profiles from reanalysis are linearly interpolated, and the height value that corresponds to the cloud-top temperature is determined. The cloud top height of clouds with large emissivities (> 0.99) are assumed to be the same as the cloud effective height. The cloud-top pressure is obtained from the cloud height using the vertical pressure profile from reanalysis. Cloud top pressure is only calculated for daytime; therefore nighttime values are set to CERES default.

SSF-114f Mean cloud top temperature for multilayer

PSF-weighted mean cloud top temperature derived from imager radiances that fall within the CERES FOV and over single and multilayer clouds. (K) [100 .. 350]], i.e. (1) and (2) for this variable correspond to the areas of (1) and (2) in SSF-114a respectively. (3) and (4) for this variable correspond to the total area covered by multilayer clouds (sum of area (3) and (4) discussed in SSF-114a).

The bin-averaged values are weighted by the imager pixel fraction of corresponding layer imager pixels to total imager pixels and PSF. If there are no imager pixels with valid cloud top temperature values or if the corresponding single layer or both multilayer area percent coverage is set to 0 or CERES default, this variable is set to CERES default.

Based on the phase, effective cloud temperature, and the cloud emissivity, the cloud retrieval uses a set of empirical formulae to compute the emissivity relative to the physical top of the cloud rather than to the effective height of the cloud. This cloud-top emissivity is used to compute an estimate of cloud-top radiance using the clear-sky and observed radiances. Cloud-

top radiance is converted to cloud-top temperature using the inverse Planck function. The tops of clouds with large emissivities (> 0.99) are assumed to be the same as the cloud effective height. Cloud top temperature is not calculated at night; the values are set to CERES default.

SSF-114g Mean cloud top height for multilayer

PSF-weighted mean cloud top height derived from imager radiances that fall within the CERES FOV and over single and multilayer clouds. (km) [0 .. 20]], i.e. (1) and (2) for this variable correspond to the areas of (1) and (2) in SSF-114a respectively. (3) and (4) for this variable correspond to the total area covered by multilayer clouds (sum of area (3) and (4) discussed in SSF-114a).

The bin-averaged values are weighted by the imager pixel fraction of corresponding layer imager pixels to total imager pixels and PSF. If there are no imager pixels with valid cloud top pressure values or if the corresponding single layer or both multilayer area percent coverage is set to 0 or CERES default, this variable is set to CERES default.

Based on the phase, effective cloud temperature, and the cloud emissivity, the cloud retrieval uses a set of empirical formulae to compute the emissivity relative to the physical top of the cloud rather than to the effective height of the cloud. This cloud-top emissivity is used to compute an estimate of cloud-top radiance using the clear-sky and observed radiances. Cloud-top radiance is converted to cloud-top temperature using the inverse Planck function. The temperature and height profiles from reanalysis (MOA) are linearly interpolated, and the height value that corresponds to the cloud-top temperature is selected. The tops of clouds with large emissivities (> 0.99) are assumed to be the same as the cloud effective height. Cloud top height is not calculated at night; the values are set to CERES default.

SSF-114h Mean cloud effective pressure for multilayer

PSF-weighted mean cloud effective pressure derived from imager radiances that fall within the CERES FOV and over single and multilayer clouds. (km) [0 .. 1100]], i.e. (1) and (2) for this variable correspond to the areas of (1) and (2) in SSF-114a respectively. (3) and (4) for this variable correspond to the total area covered by multilayer clouds (sum of area (3) and (4) discussed in SSF-114a).

The bin-averaged values are weighted by the imager pixel fraction of corresponding layer imager pixels to total imager pixels and PSF. If there are no imager pixels with valid cloud top temperature values or if the corresponding single layer or both multilayer area percent coverage is set to 0 or CERES default, this variable is set to CERES default.

The temperature and height profiles from reanalysis are linearly interpolated, and the height value that corresponds to the cloud effective temperature is determined. The cloud effective pressure is obtained from the cloud height using the vertical pressure profile from reanalysis.

SSF-114i Mean cloud effective temperature for multilayer

PSF-weighted mean effective temperature derived from imager radiances that fall within the CERES FOV and over single and multilayer clouds. (K) [100 .. 350]], i.e. (1) and (2) for this variable correspond to the areas of (1) and (2) in SSF-114a respectively. (3) and (4) for this

variable correspond to the total area covered by multilayer clouds (sum of area (3) and (4) discussed in SSF-114a).

The bin-averaged values are weighted by the imager pixel fraction of corresponding layer imager pixels to total imager pixels and PSF. If there are no imager pixels with valid cloud effective temperature values or if the corresponding single layer or both multilayer area percent coverage is set to 0 or CERES default, this variable is set to CERES default.

Cloud effective temperature is the equivalent blackbody temperature of the cloud as seen from above. The temperature of the cloud generally decreases with increasing height (decreasing pressure). Thus, the radiation intensity from different layers of a cloud varies with temperature. An integration of that radiation over the cloud thickness, including the attenuation of radiation from lower parts of the cloud by the upper layers, defines the effective temperature. That temperature corresponds to some location between the cloud base and top. The cloud retrieval obtains cloud effective temperature for each pixel first by removing the effects of the atmosphere and any contribution of the surface to the observed window channel radiance and then using the inverse Planck function to convert the adjusted radiance to temperature.

SSF-114j Mean cloud effective height for multilayer

PSF-weighted mean effective height derived from imager radiances that fall within the CERES FOV and over single and multilayer clouds. (km) [0 .. 20]], i.e. (1) and (2) for this variable correspond to the areas of (1) and (2) in SSF-114a respectively. (3) and (4) for this variable correspond to the total area covered by multilayer clouds (sum of area (3) and (4) discussed in SSF-114a).

The bin-averaged values are weighted by the imager pixel fraction of corresponding layer imager pixels to total imager pixels and PSF. If there are no imager pixels with valid cloud effective height values or if the corresponding single layer or both multilayer area percent coverage is set to 0 or CERES default, this variable is set to CERES default.

Cloud retrieval assigns cloud effective height to each cloudy imager pixels by linearly interpolating to the calculated cloud effective temperature for multilayer (See SSF-114i) using the temperature and height vertical profiles from reanalysis (MOA).

SSF-114k Mean cloud base pressure for multilayer

PSF-weighted mean cloud base pressure empirically derived imager radiances that fall within the CERES FOV and over single and multilayer clouds. (hPa) [0 .. 1100]], i.e. (1) and (2) for this variable correspond to the areas of (1) and (2) in SSF-114a respectively. (3) and (4) for this variable correspond to the total area covered by multilayer clouds (sum of area (3) and (4) discussed in SSF-114a).

The bin-averaged values are weighted by the imager pixel fraction of corresponding layer imager pixels to total imager pixels and PSF. If there are no imager pixels with valid cloud base pressure values or if the corresponding single layer or both multilayer area percent coverage is set to 0 or CERES default, this variable is set to CERES default.

Cloud retrieval obtains cloud thickness from the effective temperature and the logarithm of the optical depth for clouds colder than 245 K. For warm clouds (temperature greater than 275 K), the thickness is related to the square root of the optical depth. For clouds between these temperatures, a linear interpolation between the thickness at the two extremes is performed. The minimum cloud thickness is 100 meters. The thickest cloud is limited by the maximum cloud height. Clouds must be a minimum of 100 meters above the surface. The cloud base height is obtained by subtracting the cloud thickness from the cloud top height. The cloud bottom pressure is obtained from the cloud base height. Cloud base pressure is not calculated at night; the values are set to CERES default.

3.7 Additional Footprint Imager Radiance Statistics Definitions

SSF-131a Additional imager channel central wavelength

This parameter is an array of the seven additional imager channel central wavelengths, in the order in which the footprint imager radiance statistics are recorded.

The imager channel wavelengths for which radiance statistics are recorded can vary between footprints. The array location where the radiance statistics for a particular imager channel are recorded can also vary between footprints.

On an imager pixel level, radiance values for all imager channels of possible interest are saved. Convolution then determines which 5 imager channels are of interest for this CERES FOV and records those imager channel central wavelengths, in order, in this array.

SSF-131b Additional mean imager radiances over clear area

This parameter is a PSF-weighted mean of the radiance associated with all subpixel clear area imager pixels for each of the seven additional channels used in processing the footprint. The order in which the radiances are stored is specified in SSF-131a.

SSF-131c Additional stddev imager radiances over clear area

This parameter is a PSF-weighted standard deviation of the radiance associated with clear imager pixels for each of the seven additional channels used in processing the footprint. The order in which the radiances are stored is specified in SSF-131a.

SSF-131d Additional mean imager radiances over full CERES FOV

This parameter is a PSF-weighted mean of the radiance associated with all imager pixels convolved in the current CERES FOV for each of the seven additional channels used in processing the footprint. The order in which the radiances are stored is specified in SSF-131a.

SSF-131e Additional stddev imager radiances over full CERES FOV

This parameter is a PSF-weighted standard deviation of the radiance associated with all imager pixels convolved in the current CERES FOV for each of the seven additional channels used in processing the footprint. The order in which the radiances are stored is specified in SSF-131a.

3.8 MODIS Ocean Aerosols Definitions

SSF-161 PSF-wtd MOD04 mean reflectance ocean (0.470)

This parameter is the PSF-weighted mean of the MODIS Mean_Reflectance_Ocean at 0.470 μm associated with all imager pixels convolved in the current CERES FOV.

SSF-162 PSF-wtd MOD04 mean reflectance ocean (0.555)

This parameter is the PSF-weighted mean of the MODIS Mean_Reflectance_Ocean at 0.550 μm associated with all imager pixels convolved in the current CERES FOV.

SSF-163 PSF-wtd MOD04 mean reflectance ocean (0.659)

This parameter is the PSF-weighted mean of the MODIS Mean_Reflectance_Ocean at 0.659 μm associated with all imager pixels convolved in the current CERES FOV.

SSF-164 PSF-wtd MOD04 mean reflectance ocean (0.865)

This parameter is the PSF-weighted mean of the MODIS Mean_Reflectance_Ocean at 0.865 μm associated with all imager pixels convolved in the current CERES FOV.

SSF-165 PSF-wtd MOD04 mean reflectance ocean (1.240)

This parameter is the PSF-weighted mean of the MODIS Mean_Reflectance_Ocean at 1.240 μm associated with all imager pixels convolved in the current CERES FOV.

SSF-166 PSF-wtd MOD04 mean reflectance ocean (1.640)

This parameter is the PSF-weighted mean of the MODIS Mean_Reflectance_Ocean at 1.640 μm associated with all imager pixels convolved in the current CERES FOV.

SSF-167 PSF-wtd MOD04 mean reflectance ocean (2.130)

This parameter is the PSF-weighted mean of the MODIS Mean_Reflectance_Ocean at 2.130 μm associated with all imager pixels convolved in the current CERES FOV.

4.0 CRS Variable Descriptions

The CRS variables are not yet documented in a collection guide. The CCCM Data Products Catalog lists the variable names and provides information on units, ranges, and dimensions.

5.0 References

- Hess, M., P. Koepke, and I. Schult, 1998: Optical Properties of Aerosols and Clouds: The software package OPAC. *Bull. Amer. Meteor. Soc.*, **79**, 831-844.
- Kato, S., S. Sun-Mack, W. F. Miller, F. G. Rose, Y. Chen, P. Minnis, and B. A. Wielicki, 2010: Relationships among cloud occurrence frequency, overlap, and effective thickness derived from CALIPSO and CloudSat merged cloud vertical profiles. *J. Geophys. Res.*, **115**, D00H28, doi:10.1029/2009JD012277.
- Kato, S., F. G. Rose, S. Sun-Mack, W. F. Miller, Y. Chen, D. A. Rutan, G. L. Stephens, N. G. Loeb, P. Minnis, B. A. Wielicki, D. M. Winker, T. P. Charlock, P. W. Stackhouse, K.-M. Xu, and W. Collins, 2011: Computation of top-of-atmosphere and surface irradiances with CALIPSO, CloudSat, and MODIS derived cloud and aerosol properties. *J. Geophys. Res.*, **116**, D19209, doi:10.1029/s011JD16050.