

Information Model of the Tendering System for Large Projects

Lyubomyr Chyrun^[0000-0002-9448-1751]¹, Iurii Turok², Ivan Dyyak^[0000-0001-5841-2604]³

^{1,3}Ivan Franko National University of Lviv, Lviv, Ukraine

²Talentry, Munich, Germany

Lyubomyr.Chyrun@lnu.edu.ua, ivan.dyyak@lnu.edu.ua

Abstract. The task of creating an information system for tendering large projects is considered. Determined by a number of functions that the system is designed to perform. Based on the tasks, the requirements to the interface and functionality are formed. The article proposes a model of decision tree according to which the system will provide the advice. Significant attention is given to the description of information model in general and data streams

Keywords. Tender, Big Project, Information System

1 Introduction

At the moment there is a large number of both public and private orders, which is an integral part of market relations on which the economy is built by most countries of the world and our country in particular [1-3]. The trend of creating large-scale projects that are always accompanied by tenders is growing in the world. Tenders always require troublesome work with documentation necessary for their carrying out, systematization of all necessary data and comparison of characteristics and peculiarities of participants for determination of Leader. Therefore, the need for information systems capable to organize such tenders every day grows in proportion with the growth of the population and its needs. It is especially necessary to have such systems after the implementation of the Law of Ukraine on the necessity to post information on tenders for information resources [4-6].

2 The Statement of the Problem as a General

Information technologies are developing at a rapid pace, so their use should optimize existing tendering processes, develop new methods for gathering information, the interface of work with clients, as well as to design a system of such In order to minimize human costs, the support of the tendering system is aimed. In the analysis of each process, it is necessary to consider the optimality factor as the main one, so that

Copyright © 2020 for this paper by its authors.
Use permitted under Creative Commons License Attribution 4.0 International (CC BY 4.0).

the system performance is at the highest level. This will help to create a competitive tendering system and give an opportunity to occupy a suitable niche among existing systems. Integrating new information features should be accompanied at every stage of the system design.

3 Analysis of Researches and Publications

The general system of public tenders is defined by the provisions of the legislative acts of Ukraine and its main points are prescribed in the "Law of Ukraine on the conditions and procedure of tenders (contests) for the definition of specialized organizations" [5-9]. As for the organization of commercial non-governmental tenders, there are many studies and publications regarding the organization of the tender (PR, organization Number of Parties...). However, publications in the field of information systems for control, automation or tendering are not found. There are several commercial projects that are functioning successfully at the moment: Ua-tenders, Tender.ua, uatender.com, e-tenders.com.ua. One of the largest and most popular such systems is the information web system Ua-Tenders. It is certified by the Ministry of Economy, entered in the State Register of public procurement specialists in Ukraine, the database dimension of over 200000 tenders updated each day. However, this is a process automation system that does not provide advice or generates any of its own evaluation. And also, it is not possible to consider tenders as a major project. For the success of such New tender that is not available on existing systems.

4 Highlighting the Problem

In contrast to the already existing systems of this type, the projected system should consider a tender as a large project, consisting of several tenders, and effectively work with it, as with a simple one-component tender. It is cooperation with information systems that operate at the time to exchange experiences, knowledge base and data, which will significantly improve the productivity of our system. The intellectual system (IS) should organize tendering process without the supervision of a tender expert, provide advice and draw conclusions [10-17].

A number of tasks that an intelligent system should perform [18-26]:

- Process control of tender;
- Collection and systematization of customer data;
- Formation and announcement of tenders;
- Possibility of accepting applications and determining their compliance;
- Analyzing and processing data needed to determine the outcome;
- Defining leader and evaluating the remaining members
- Notification of the Parties about tender results;
- Tips and advice on each stage of the tendering process.

Since this industry is currently quite actively investigated by analysts and experts, it is necessary to provide prospects for future improvements and reorganizations. My vision of improving capabilities and functions is as follows [27-36]:

- Functioning of the system in the Internet space, providing web. Interface.
- Possibility of notification of clients existing in the DATABASE on tender in their field through communication means;
- Organization of different methods of customer notifications about tender process and results using modern means of communication;
- The ability to automatically fill the database with clients, who may be potential participants of a particular tender;
- Ensuring cooperation with the information systems of similar type to exchange data and opportunities.

So it is possible with confidence to say these and several other tasks, the system is able to satisfy the wishes and needs of clients, as those representing public property and private.

5 Objectives and Tasks of the Article

The purpose of this article is to solve the following tasks:

1. Define functional requirements for the projected information system;
2. Based on the outlined functional needs, determine the appearance of the nucleus of the information system, how will be stored processed data and accrued result;
3. Offer practical solutions on specific tasks that rely on the information system.
4. Describe the expected effects of the implementation of the system.

6 Main Material of Research

6.1 Defining Functional Requirements

To design such a system, you need to do the following steps:

1. Analyze and describe the system
2. Develop a conceptual model
3. Develop data logical model
4. Development of convenient interface and information input and output
5. Development of architecture and combination of all modules.

Let' depict the system's functioning requirements with SYSML Diagram (Fig.1) [3].

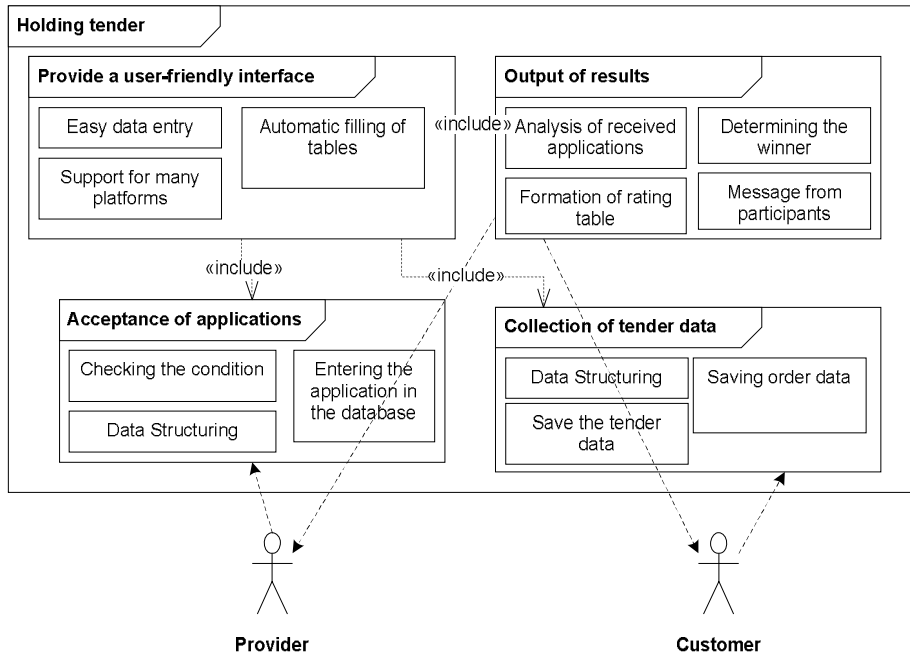

Fig. 1. SYSML Tendering System Requirements Chart

6.2 Information System Kernel View Definition

The information system should be adapted for organizing tenders of large projects. A large project (tender) can consist of several tenders that divide the main order into multiple orders. This is due to the fact that large projects often set themselves to perform tasks from different industries, which makes it impossible the task of a single supplier. Each tender consists of a proposal (sub-order), which has its own conditions and several applications that satisfy these terms (Fig. 2).

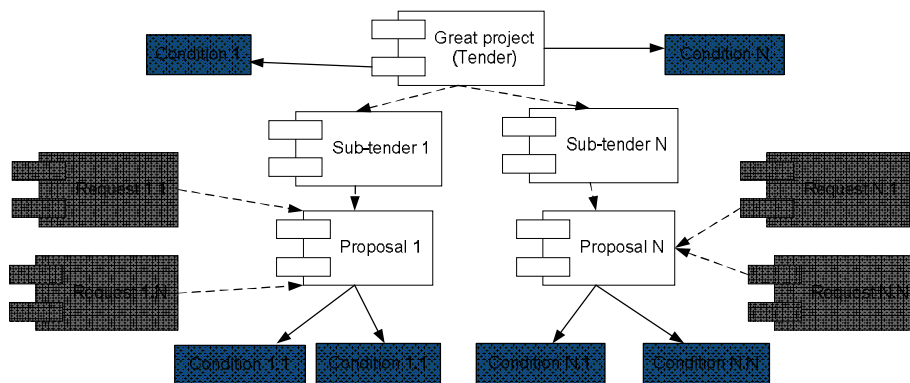

Fig. 2. UML Component Diagram – A diagram of a system for tendering of large projects

We will analyze the activity of the system of tenders according to the general tendering process. Information about the system (as a user) the sequence of actions that it must perform to achieve the purpose and for the developer, who is implementing the software part of the system. Show what processes can be performed simultaneously, and which require a preliminary assessment of other parts or processes of the system (Fig. 3) [4].

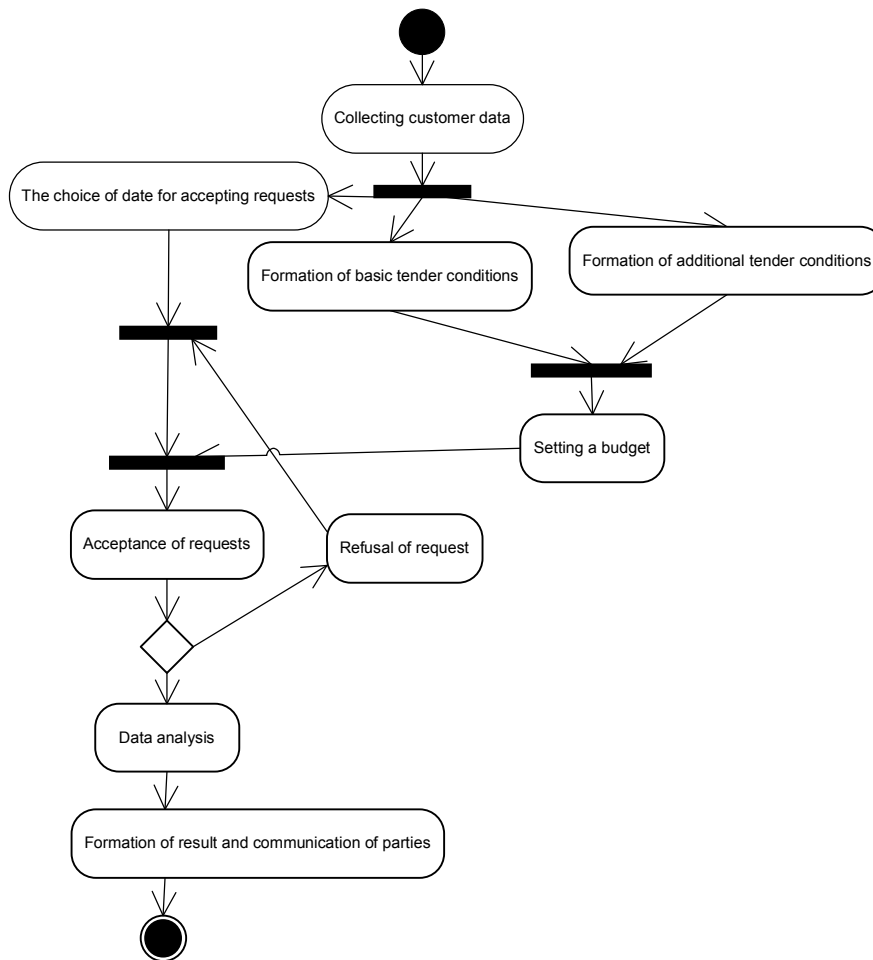

Fig. 3. UML Activity Diagram of the tendering system for large projects

The system interface with the outside world, namely, the information flows between the system and the external entities with which it should be connected consists of information flows between the customers and suppliers, and the IS itself, as it processes and stores information in Database. Let's identify these external entities as well as the only process that reflects the main purpose or nature of system (Fig. 4-5) [1].

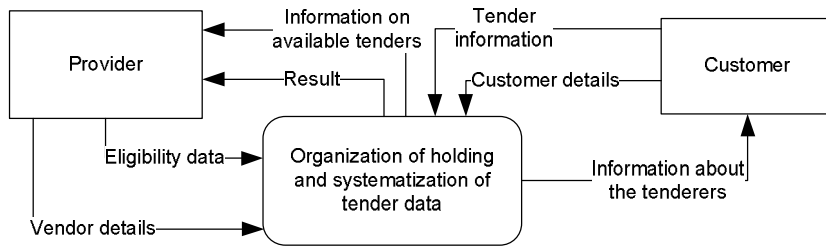

Fig. 4. DF Diagram of the tendering system for large projects

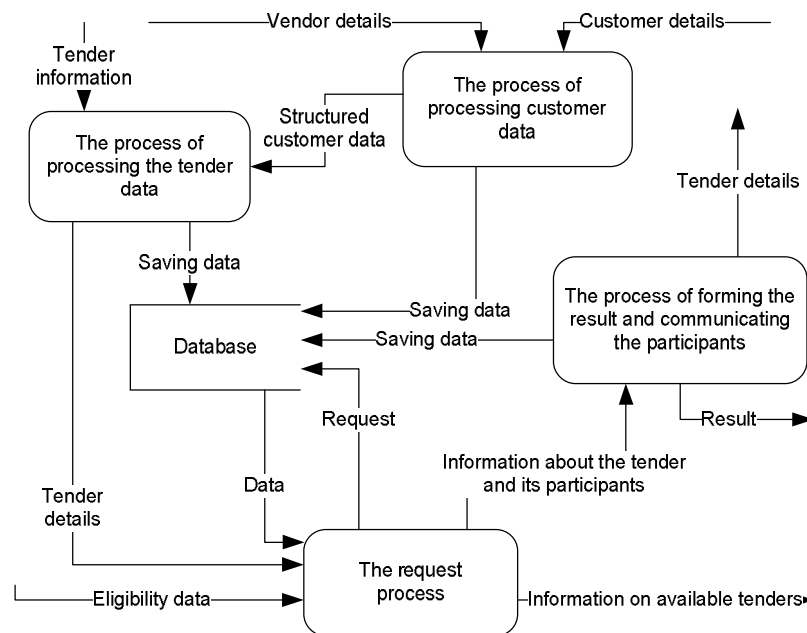

Fig. 5. DF Diagram of system of tenders for large level 1 projects

Information streams of incoming and outgoing data contain information about tender, order, customer, supplier, application, and system management. The initial data is the outcome of the tendering process, structured customer information and tender (Fig. 6). For proper collection of knowledge and processing of incoming information necessary for the design and operation of the tendering system for large projects, a certain model should be selected with the help they will be shown for further processing and Save.vOne of the most user-friendly unified Data View Tools is the "Essence-Link" (Entity-RELATIONSHIP model, ER-model) model [2]. The "entity-relationship" model is based on some important semantic information about the real world and is intended for logical representation of the data. In our case, information is about tenders of their participants, elements of objects and subjects of their holding. It defines

the values of data in the context of their relationship with other data. The fact that from the "Essence-link" model can be generated by all existing data models (hierarchical, network, relational, object), so it is the most common.

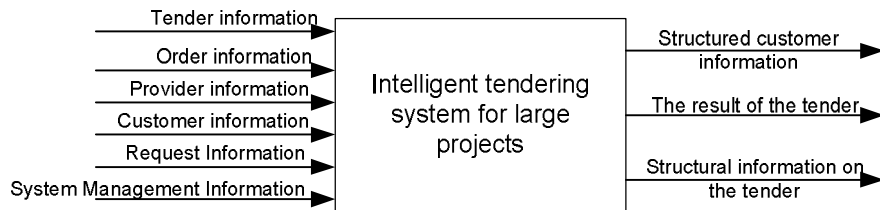

Fig. 6. General model of tendering system

Any fragment of the projected system can be represented as a set of entities between which there is a set of links. It is possible to allocate the following main entities: Supplier, application, hanged person, tender, customer, and offer.

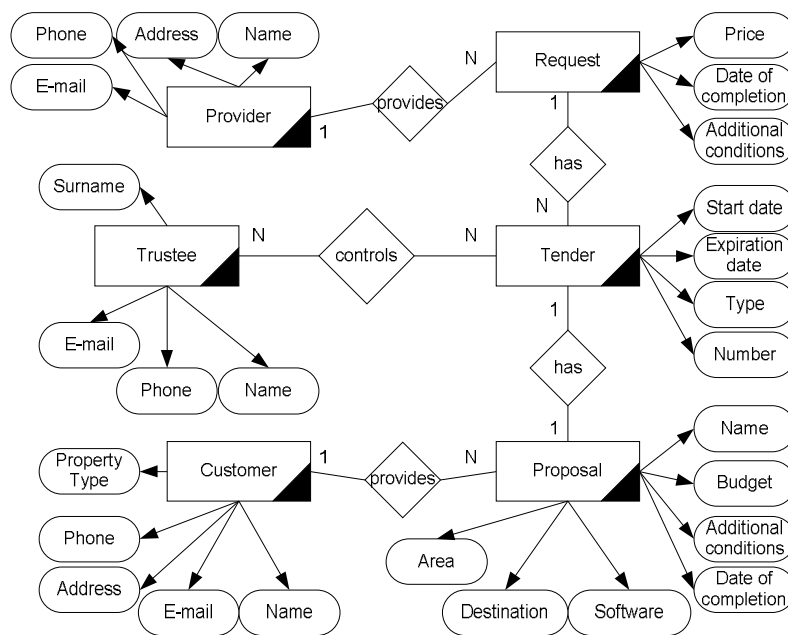

Fig. 7. Knowledge representation with the help of the entity-relationship model in a notation marked

To design the database structure, use the method of semantic modeling. Semantic modeling is the modeling of data structure, relying on the meaning of this data. Various chart variations are used as a semantic modeling tool (ER - Entity-Relationship).

In developing ER-models, it is necessary to obtain the following information about tender and objects and subjects involved in its conduct:

1. List of tender entities.
2. List of entity attributes.
3. Description of relationships between entities.

ER charts are convenient because the process of allocating entities, attributes, and relationships is iterative. Having developed the first approximate version of the diagrams, we specify them, with the decomposition analysis of the system. This documentation, which records the results of the analysis, is the ER charts. [2]

We will describe the work with ER-diagrams close to the Barker's notation, as quite easy in understanding of the basic ideas. This section is rather illustration semantic modeling methods, than complete introduction into this area.

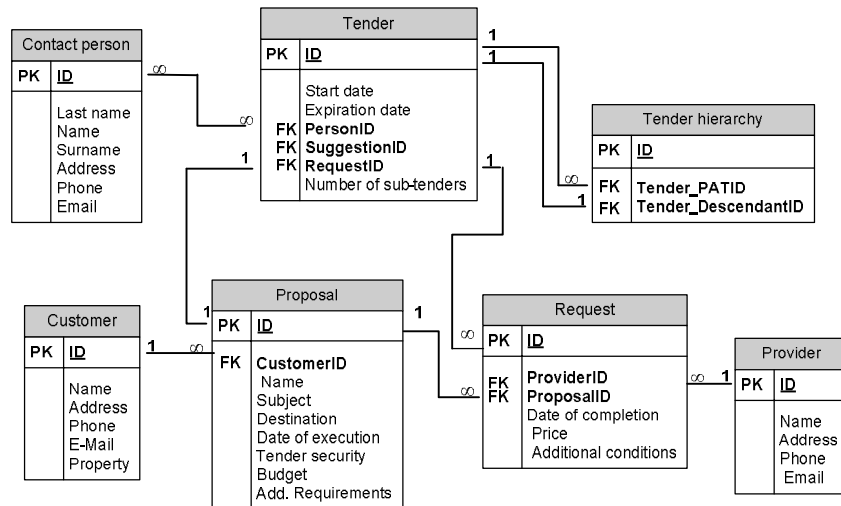

Fig. 8. ER – the IS chart for holding tenders of large projects.

Each entity has its own number (ID), which basically is the connection between the entities. Most relationships between entities are type one-to-many. Let's depict the verbal with each of these links:

- **One** *Tender* contains **one** *Proposal*;
- **One** *Tender* can contain **one** *Tender Father* (Hierarchy of tenders);
- **One** *Tender* can contain **many** *Tender descendants* (Hierarchy of tenders);
- **One** *Customer* can provide **many** *Proposals*;
- **One** *Provider* can provide **many** *Request*;
- **Many** *Requests* can be provided for **one** *Tender*;
- **Many** *Requests* satisfy **one** *proposal*;

- **Many Contact persons control many Tenders**
- **(One Contact person can control many Tenders i One tender can control many Contact persons);**

Association between the entity the contact and tender entity should be done in many-to-many relationships, but given that it is difficult to implement this relationship in practice, it will apply one to many links. Each developed block and model of developed information system must interact and exchange data among themselves. This happens as follows (Fig 9):

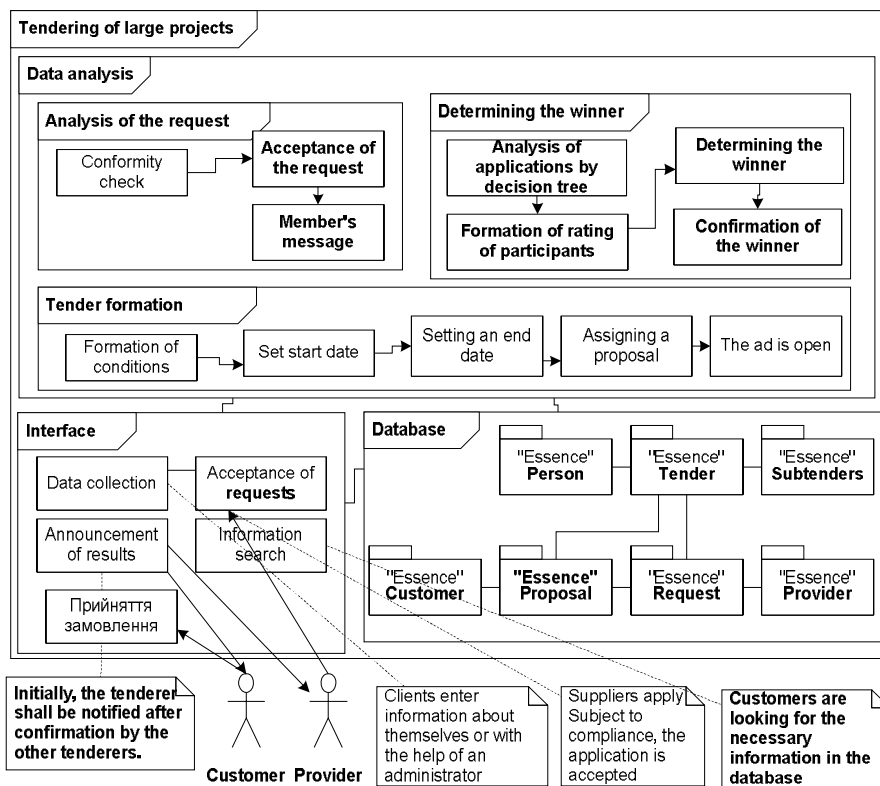

Fig. 9. SYSML Block diagram systems for tenders

6.3 Practical Solutions for Specific Problems

In order to present knowledge in the system of tenders for large projects, it is recommended to use two basic methods: by using a database designed using Microsoft SQL Server tools, as well as the designer design of an ADO database .NET in an environment in Microsoft Visual Studio 2008 programming Languages C#. The following rules are used to represent the code, in the form of logical operators and selector operators, which are represented using classes-objects. This is due to the use of object-

oriented programming. This ensures that all the necessary requirements for submitting the rules are fulfilled in the system. This type of data image corresponds to a modern vision of knowledge preservation, and provides an opportunity for quick, alteration, addition or removal of specific knowledge. In addition, it provides substantial benefits in considering the use of time and human costs necessary to create design and maintain operation. The methods of logical derivation of decisions in the system are performed either directly through the graphical intelligent interface or there is a possibility through the peripheral device type printer. The intelligent graphical interface will combine the interface with the database, with the knowledge and apparatus of decision making and formation of conclusions and analyses. Decisions in the system are made in accordance with the conditions of tendering and action of the user, the system is built in object-oriented style, so the reaction to each user action is a certain method, a specific object necessary to satisfy the execution of actions of the user. Data storage is implemented by using a relational database model.

6.4 Expected Effects from System Implementation

The use of the system is quite wide, ranging from different institutions or organizations, even legal entities who individually want to hold a tender, and for mass use, where everyone has the opportunity to submit an offer for the organization Tender or apply for participation in the already established tender. The main consumer and client are public institutions, as most of all tenders that are conducted on the territory of Ukraine is state order. Therefore, users will be employees of this type of institutions or organizations that specialize in tendering, experts in the field of tender documentation, procurement markets for a certain analysis through the system.

The use of information communication technologies should optimize the tendering process and create an effective organizational structure.

Each information system should foresee an element of economic effect, so that the system can ensure the possibility of further functioning and provide developers with the impact of time and economic resources on its creation. This effect is provided by the system due to various methods. The main sources are customers who want to tender, those who want to apply for tenders, and those who simply need information about available tenders, suppliers or customers. Another potential source of similar systems may be to use a database of a projected system of tenders for large projects. Therefore, the following ways of obtaining the economic effect are envisaged:

1. By registering clients in the system for receiving information concerning tenders, suppliers, customers and available tender experts. This type of foreclosure may be urgent in nature, one-off or relatively amount of information.
2. By obtaining tender documents for tenders that are conducted. This type uses most of the information systems of this type.
3. Due to the percentage from economic success of the tender.
4. By granting access to other systems to the database.

Thus, we can say with confidence that the system is able to provide not only economic resources its functioning but also their accumulation for further development and improvement of the system. In addition to the economic effect, such a system contains an organizational effect that will reduce the loading of personnel, for example, in the organization of tenders, engaged in troublesome work related to collecting, analyzing data and various types of work with Documents. Also, the existence of such a system in each institution that is the permanent initiator of tenders, eliminates the need to use the services of agencies or organizations engaged in tendering, which in turn will be the authority of the institution and Morale of the workers.

7 Conclusions

For the projected information system the necessary functions were defined, on the basis of which the functional requirements of the core system were formed and the question: in what form and structure the data should be stored, so that the system effectively Solve the necessary tasks. Also predictable effects of the implementation of the system are considered. The main problems that had not been touched by this time were: Intellect ability of the system when choosing the winner of the tender, organization of tender of large projects and how to keep information about the hierarchical structure of this data? During the writing of the article, these questions were resolved and described. Thus, it can be concluded that the information system is described in the article in general and can be technically implemented with the help of arbitrary platforms and technologies and it can be used from different institutions or organizations, even legal entities that individually want to hold a tender and for mass use, where everyone has the opportunity to submit an offer for the organization of a tender or apply for participation in the already established tender

References

1. Brook, M.: Estimating and tendering for construction work. Taylor & Francis. (2016)
2. Ajam, M., Alshawi, M., Mezher, T.: Augmented process model for e-tendering: Towards integrating object models with document management systems. In: Automation in Construction, 19(6), 762-778. (2010)
3. Object Management Group., OMG SYSML Specification, www.omg.org. (2019)
4. Object Management Group. OMG Unified Modeling Language Specification. (2019)
5. Ma, Z., Wei, Z., Zhang, X.: Semi-automatic and specification-compliant cost estimation for tendering of building projects based on IFC data of design model. In: Automation in Construction, 30, 126-135. (2013)
6. Zhiliang, M., Zhenhua, W., Wu, S., Zhe, L.: Application and extension of the IFC standard in construction cost estimating for tendering in China. In: Automation in Construction, 20(2), 196-204. (2011)
7. Hu, Z. Z., Zhang, J. P., Yu, F. Q., Tian, P. L., Xiang, X. S.: Construction and facility management of large MEP projects using a multi-Scale building information model. In: Advances in Engineering Software, 100, 215-230. (2016)

8. Van Der Meer, J., Hartmann, A., Van Der Horst, A., Dewulf, G.: Challenges of using systems engineering for design decisions in large infrastructure tenders. In: *Engineering project organization journal*, 5(4), 133-145. (2015)
9. Vysotska, V., Hasko, R., Kuchkovskiy, V.: Process analysis in electronic content commerce system. In: *Proceedings of the International Conference on Computer Sciences and Information Technologies, CSIT 2015*, 120-123 (2015)
10. Lytvyn, V., Vysotska, V.: Designing architecture of electronic content commerce system. In: *Computer Science and Information Technologies, Proc. of the X-th Int. Conf. CSIT'2015*, 115-119 (2015)
11. Lytvyn, V., Vysotska, V., Veres, O., Rishnyak, I., Rishnyak, H.: The Risk Management Modelling in Multi Project Environment. In: *Computer Science and Information Technologies, Proc. of the Int. Conf. CSIT*, 32-35 (2017)
12. Vysotska, V., Fernandes, V.B., Emmerich, M.: Web content support method in electronic business systems. In: *CEUR Workshop Proceedings, Vol-2136*, 20-41 (2018)
13. Gozhyj, A., Kalinina, I., Vysotska, V., Gozhyj, V.: The method of web-resources management under conditions of uncertainty based on fuzzy logic, 2018 IEEE 13th International Scientific and Technical Conference on Computer Sciences and Information Technologies, CSIT 2018 – Proceedings 1, 343-346 (2018)
14. Gozhyj, A., Vysotska, V., Yevseyeva, I., Kalinina, I., Gozhyj, V.: Web Resources Management Method Based on Intelligent Technologies, *Advances in Intelligent Systems and Computing*, 871, 206-221 (2019)
15. Vysotska, V., Chyrun, L.: Analysis features of information resources processing. In: *Computer Science and Information Technologies, Proc. of the Int. Conf. CSIT*, 124-128 (2015)
16. Lytvyn, V., Kuchkovskiy, V., Vysotska, V., Markiv, O., Pabyrivskyy, V.: Architecture of system for content integration and formation based on cryptographic consumer needs, 2018 IEEE 13th International Scientific and Technical Conference on Computer Sciences and Information Technologies, CSIT 2018 – Proceedings 1, 391-395 (2018)
17. Chyrun, L., Vysotska, V., Kis, I., Chyrun, L.: Content Analysis Method for Cut Formation of Human Psychological State, *Proceedings of the 2018 IEEE 2nd International Conference on Data Stream Mining and Processing, DSMP 2018*, 139-144 (2018)
18. Vysotska, V., Chyrun, L., Chyrun, L.: Information Technology of Processing Information Resources in Electronic Content Commerce Systems. In: *Computer Science and Information Technologies, CSIT'2016*, 212-222 (2016)
19. Vysotska, V., Rishnyak, I., Chyrun L.: Analysis and evaluation of risks in electronic commerce, *CAD Systems in Microelectronics, 9th International Conference*, 332-333 (2007).
20. Lytvyn, V., Vysotska, V., Demchuk, A., Demkiv, I., Ukhanska, O., Hladun, V., Kovalchuk, R., Petruchenko, O., Dzyubyk, L., Sokulska, N.: Design of the architecture of an intelligent system for distributing commercial content in the internet space based on SEO-technologies, neural networks, and Machine Learning. In: *Eastern-European Journal of Enterprise Technologies*, 2(2-98), 15-34. (2019)
21. Lytvyn, V., Vysotska, V., Kuchkovskiy, V., Bobyk, I., Malanchuk, O., Ryshkovets, Y., Pelekh, I., Brodyak, O., Bobrivetc, V., Panasyuk, V.: Development of the system to integrate and generate content considering the cryptocurrent needs of users, *Eastern-European Journal of Enterprise Technologies* 1(2-97), pp. 18-39 (2019)
22. Lytvyn, V., Vysotska, V., Rzhеuskyi, A.: Technology for the Psychological Portraits Formation of Social Networks Users for the IT Specialists Recruitment Based on Big Five, NLP and Big Data Analysis. In: *CEUR Workshop Proceedings*, 2392, 147-171. (2019)

23. Lytvyn, V., Vysotska, V., Shakhovska, N., Mykhailyshyn, V., Medykovskyy, M., Peleshchak, I., Fernandes, V. B., Peleshchak, R., Shcherbak, S.: A Smart Home System Development. In: *Advances in Intelligent Systems and Computing IV*, 1080, 804-830. (2020)
24. Lytvyn, V., Kowalska-Styczen, A., Peleshko, D., Rak, T., Voloshyn, V., Noennig, J. R., Vysotska, V., Nykolyshyn, L., Pryshchepa, H.: Aviation Aircraft Planning System Project Development. In: *Advances in Intelligent Systems and Computing*, 1080, 315-348. (2020)
25. Lytvyn, V., Vysotska, V., Shatskykh, V., Kohut, I., Petruchenko, O., Dzyubyk, L., Bobrivets, V., Panasyuk, V., Sachenko, S., Komar, M.: Design of a recommendation system based on Collaborative Filtering and machine learning considering personal needs of the user. In: *Eastern-European Journal of Enterprise Technologies*, 4(2-100), 6-28. (2019)
26. Babichev, S.: An Evaluation of the Information Technology of Gene Expression Profiles Processing Stability for Different Levels of Noise Components. In: *Data*, 3 (4-18). (2018)
27. Babichev, S., Durnyak, B., Pikh, I., Senkivskyy, V.: An Evaluation of the Objective Clustering Inductive Technology Effectiveness Implemented Using Density-Based and Agglomerative Hierarchical Clustering Algorithms. In: *Advances in Intelligent Systems and Computing*, 1020, 532-553. (2020)
28. Vysotska, V., Chyrun, L.: Methods of information resources processing in electronic content commerce systems. In: *Proceedings of 13th International Conference: The Experience of Designing and Application of CAD Systems in Microelectronics, CADSM*. (2015)
29. Andrunyk, V., Chyrun, L., Vysotska, V.: Electronic content commerce system development. In: *Proceedings of 13th International Conference: The Experience of Designing and Application of CAD Systems in Microelectronics, CADSM 2015-February*. (2015)
30. Alieksieieva, K., Berko, A., Vysotska, V.: Technology of commercial web-resource processing. In: *Proceedings of 13th International Conference: The Experience of Designing and Application of CAD Systems in Microelectronics, CADSM 2015-February*. (2015)
31. Emmerich, M., Lytvyn, V., Yevseyeva, I., Fernandes, V. B., Dosyn, D., Vysotska, V.: Preface: Modern Machine Learning Technologies and Data Science (MoML&T&DS-2019). In: *CEUR Workshop Proceedings*, Vol-2386. (2019)
32. Lytvyn, V., Vysotska, V., Mykhailyshyn, V., Peleshchak, I., Peleshchak, R., Kohut, I.: Intelligent system of a smart house. In: *3rd International Conference on Advanced Information and Communications Technologies, AICT*, 282-287. (2019)
33. Gozhyj, A., Kalinina, I., Gozhyj, V., Vysotska, V.: Web service interaction modeling with colored petri nets. In: *Proceedings of the 2019 10th IEEE International Conference on Intelligent Data Acquisition and Advanced Computing Systems: Technology and Applications, IDAACS 2019*, 1,8924400, pp. 319-323 (2019)
34. Antonyuk, N., Medykovskyy, M., Chyrun, L., Dverii, M., Oborska, O., Krylyshyn, M., Vysotsky, A., Tsiura, N., Naum, O.: Online Tourism System Development for Searching and Planning Trips with User's Requirements. In: *Advances in Intelligent Systems and Computing IV*, Springer Nature Switzerland AG 2020, 1080, 831-863. (2020)
35. Rzheuskyi, A., Kutyuk, O., Voloshyn, O., Kowalska-Styczen, A., Voloshyn, V., Chyrun, L., Chyrun, S., Peleshko, D., Rak, T.: The Intellectual System Development of Distant Competencies Analyzing for IT Recruitment. In: *Advances in Intelligent Systems and Computing IV*, Springer, Cham, 1080, 696-720. (2020)
36. Rusyn, B., Pohreliuk, L., Rzheuskyi, A., Kubik, R., Ryshkovets Y., Chyrun, L., Chyrun, S., Vysotskyi, A., Fernandes, V. B.: The Mobile Application Development Based on Online Music Library for Socializing in the World of Bard Songs and Scouts' Bonfires. In: *Advances in Intelligent Systems and Computing IV*, Springer, 1080, 734-756. (2020)