

Graphene Aided Rectangular DRA For 5G Application: A Comparative Analysis

Arun Kumar^a, Arun Singh^a, Ayush Mittal^a, Atul Kumar^a, Saurabh Katiyar^a

^a Galgotia's College of Engineering and Technology, Knowledge Park II, Greater Noida-201306, India

Abstract.

A graphene aided rectangular dielectric resonator antenna is designed for 5G application and results are measured with different parameters. Silicon made dielectric resonator is containing four graphene rectangular layers is made for measuring the changes in the frequency response. By changing the chemical potential of graphene rectangular plates placed on the silicon rectangular dielectric resonator antenna the resonance THz frequency can be changed accordingly. The measured results for an RDRA show an impedance bandwidth of 69.81% between the frequency range 3.89 THz to 8.062 THz, and the gain of 5.082 dB.

Keywords 1

Graphene rectangular layer, Antenna, silicon, Dielectric resonator

1. Introduction

For many years, continuous research is done to study the dielectric resonator antenna (DRA), because of its various attractive characteristics, like lightweight, low profile, and greater radiation efficiency. For the wireless communication application in the last few years, a DRA (dielectric resonator antenna) is used. As compared to various different antenna DRA has a very much smaller number of losses, and this is because of as DRA doesn't contain any metal structure for radiation of signal. DRA can be designed in various different shapes like triangular, cylindrical, rectangular, and hemisphere. The DRA provides high radiation efficiency, flexibility in feeding arrangements, simple shape, and closeness. Various techniques is used for the excitation of DRA such as by microstrip line and microstrip slot and also by a coaxial probe and co-planar waveguide [1]. The THz band frequency has the capability of providing a broad bandwidth and due to this, the data transfer rate is also high. Rectangular DRA has three independent geometrical dimensions and therefore it provides us the freedom in the designing flexibility as compared to the other shape DRAs.

DRA designs for THz frequency range with the use of silicon made dielectric resonator. The silicon material has a high permittivity due to which the radiation properties like gain and radiation efficiency can be improved. Silicon is easily available therefore provide ease in the fabrication process [1]. In DRA by changing the chemical potential of four graphene rectangular layers we can obtain the changes in the frequency response of the DRA. The problem of low gain and low radiation efficiency can be solved by the use of graphene material on the sides of the rectangular dielectric resonator.

Accordingly, in the present paper, the designing of a simple RDRA (rectangular dielectric resonator antenna) that can be operated at the Terahertz frequency range is done. The comparison is done between RDRA with graphene layer and without graphene layer, and performance of both antennas is represented in terms of return losses, radiation pattern, gain, and efficiency.

WCNC-2021: Workshop on Computer Networks & Communications, May 01, 2021, Chennai, India.

EMAIL: arunsingh17719@gmail.com (Arun Singh)

ORCID: 0000-0002-3102-3059 (Arun Singh)



© 2021 Copyright for this paper by its authors.

Use permitted under Creative Commons License Attribution 4.0 International (CC BY 4.0).



CEUR Workshop Proceedings (CEUR-WS.org)

2. Design of Proposed RDRA

The Sample model of RDRA is shown in Figure 1. Which is involving a silicon dioxide substrate with dielectric constant ($\epsilon_s=4$) with the dimensions $42(L_{SUB}) \times 42(W_{SUB}) \times 8(H_{SUB}) \text{ um}^3$ which is kept on top of the ground plane. The ground plane made of silver with dielectric constant ($\epsilon_s=1$) has dimension $42(L_G) \times 42(W_G) \times 8(H_G) \text{ um}^3$. A silicon dielectric resonator ($\epsilon_r=11.9$) having dimensions $3.5(L_R) \times 3.5(B_R) \times 3(H_R) \text{ um}^3$ is placed on top of the substrate.

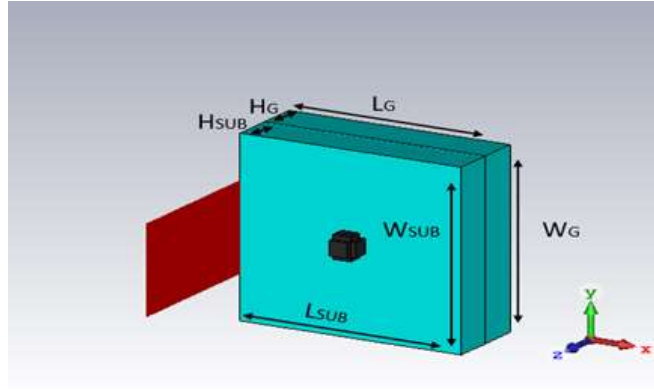

Figure.1: Configuration of Proposed Resonator Antenna Resonator

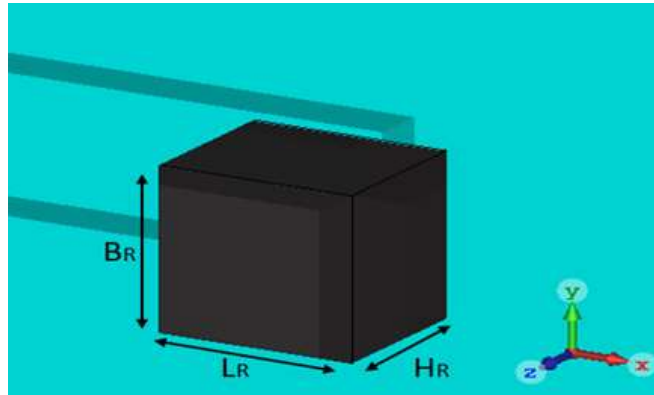

Figure 2: Perspective View of Rectangular Resonator

Silicon distributing profile is constant over the band of guiding frequency. Afterward, the size of the antenna has been optimized for getting the desired result. The mode of excitation of the dielectric resonator depends upon the value feeding technique and aspect ratio of the antenna. The rectangular resonator provides the distribution of field at 5.535 THz resonance frequency. The dielectric resonator is mounted above the slot of width $3.4 \mu\text{m}$ and length of $3.4 \mu\text{m}$ and it is located on the backside of the dielectric resonator. Figure 2 shows the dielectric resonator. The excitation applied to the dielectric resonator by microstrip feedline made of silver material ($\epsilon_f=1$) having a thickness of $1 \mu\text{m}$ shown in Figure 3, for the lower frequency range, the constructive and dispersive properties of silver material used as antenna parameter. For getting the tunability in result of antenna, The graphene layer having properties define by parameters like relaxation time, chemical potential at temperature=300k is deposited on the dielectric resonator clarified in Figure 4. The structure of the antenna is implemented by the CST microwave studio.

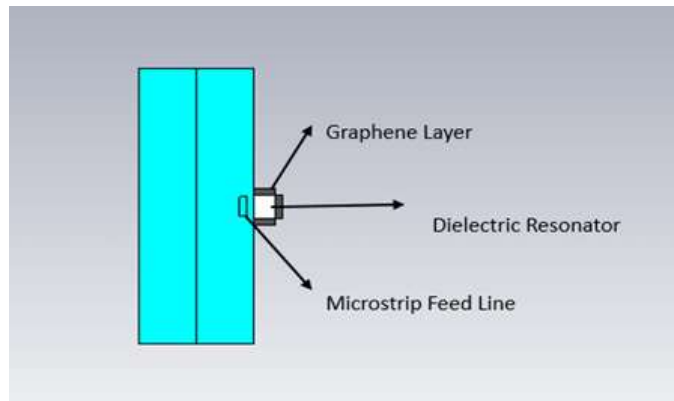

Figure 3: Side View of RDRA

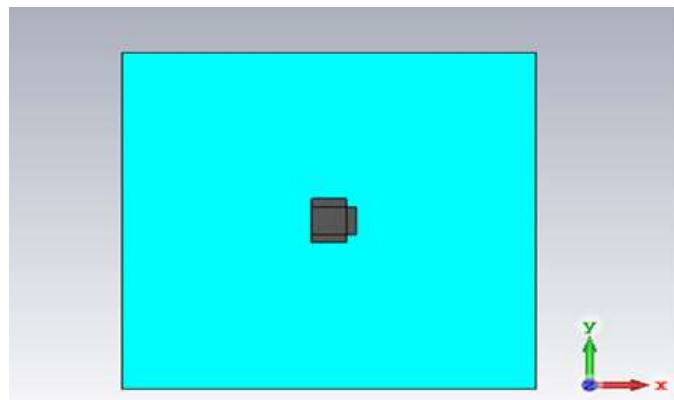
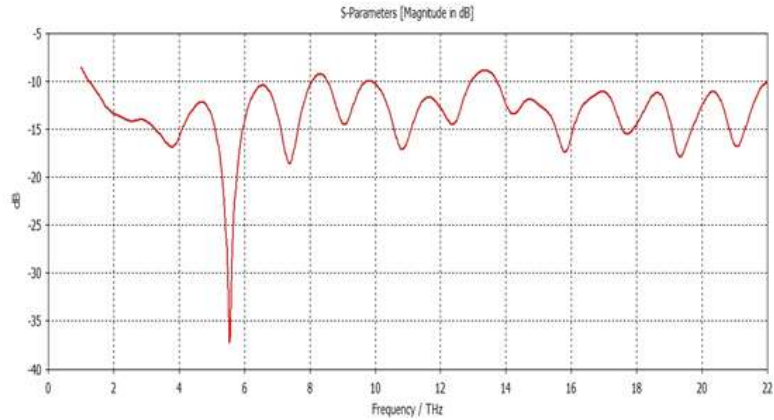

Figure 4: Top View of RDRA

3. Result and Discussion

For understanding antenna operation, the authors analyzed the result of two structures, one is implemented without the graphene layers and another is implemented with graphene layers. Figure 5 indicating the result of S11 for both the antenna at a resonance frequency. The graphene rectangular layer is placed on three sides and top of the dielectric resonator. The impedance of the antenna is non-reactive and its real parts lie in the resonance frequency. The graphene layer having properties i.e., chemical potential ($\mu_c = 0$ eV) and relaxation time ($\tau=1$ ps) at temperature (300 K) causes frequency response and resonant frequency to shift in the forward direction. The new resonant frequency of the antenna becomes 5.535 THz after the graphene layer is being placed on the top of the dielectric resonator. The displacement in the resonant frequency is responsible for the changes in the medium and material properties at the linking of silicon dielectric resonator and graphene boundaries placed on resonator's outer surface. Also, it denotes that changing the electrical properties of materials placed on the dielectric resonator can tune the antenna response. The rectangular graphene layer remains non-resonator over the frequency range. The impedance bandwidth of the antenna is observed to be approximately the same in both cases. A rectangular cut on a dielectric resonator gives the desired result of the antenna.



(a)

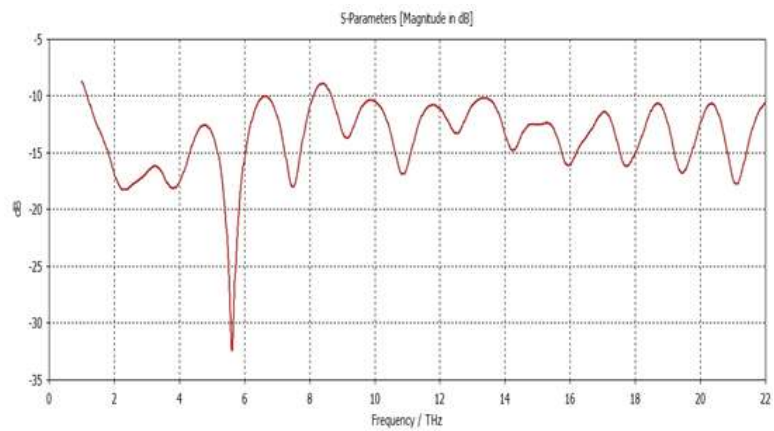

(b)

Figure 5: Return loss versus Frequency plot for RDRA (a) with graphene layer (b) without graphene layer

The comparison of the S11 parameter is shown in Figure 5 with and without the graphene layer. S11 represents how much power is reflected from the antenna. It is observed that the DR with graphene layer has return loss (S11) of -37.29 dB at frequency 5.53 THz, and the DR without graphene layer has return loss (S11) of -32.475 dB at frequency 5.62 THz. Hence the RDRA with graphene layer has a better S11 parameter as compare to the RDRA without graphene layer.

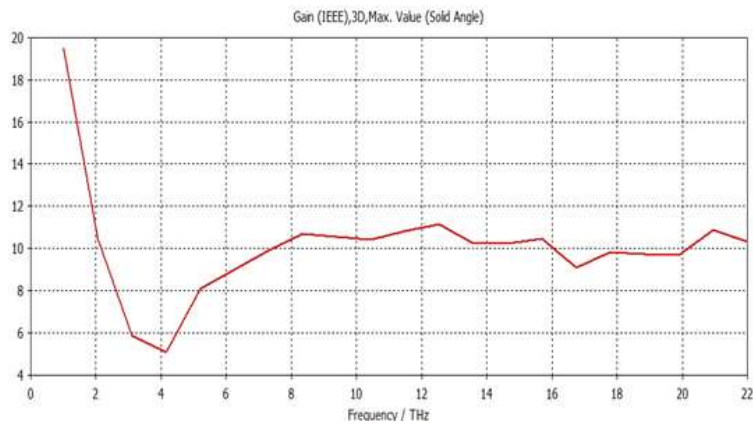

(a)

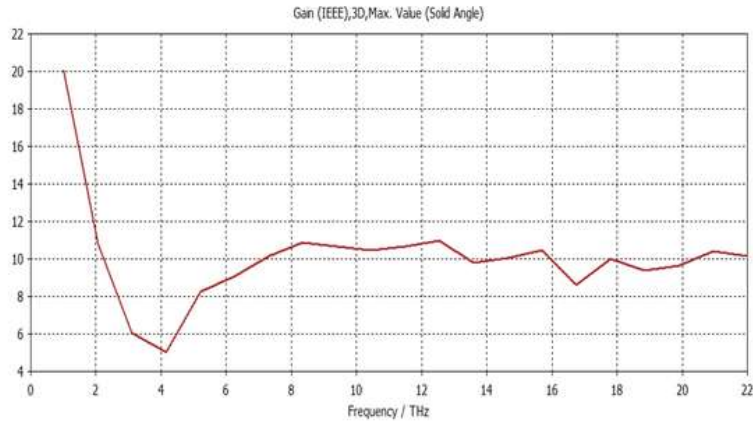

(b)

Figure 6: Gain versus frequency plot (a) with graphene layer (b) without graphene layer

Figure 6 shows a comparison of the Gain versus frequency plot of RDRA with and without graphene layer. It is observed that the DR with graphene layer has a Gain of 5.082 dB shown in Figure 6(a) and the DR without graphene layer has a Gain of 4.998 dB shown in Figure 6(b). In gain also the RDRA with graphene layers has better result as compare to RDRA without graphene layer.

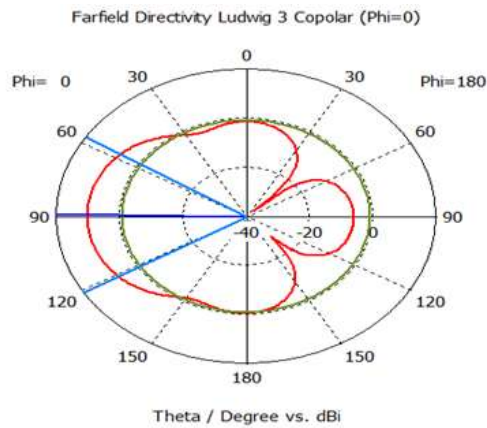

(a)

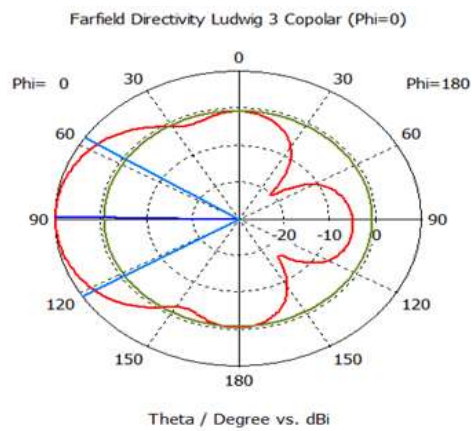

(b)

Figure.7 Co-Polar plot of RDRA (a) with graphene layer (b) without graphene layer

Figure 7 illustrates the Co-polar plot of RDRA with graphene layer and without graphene layer. Co-polar means when the polarization of both the transmitting and receiving antenna (reference horn antenna) is the same. The Co-Polar and Cross-polar plot gives the information about information transmitted and received by the antenna. The separation between the co-polarized and cross-polarized components of the radiated far-field is more than 60 dB which shows a good signal detection capability of antenna at receiver with the graphene and without the graphene in both. Figure 7 (a) shows the Co-polar plot of the RDRA with the graphene layers and Figure 7(b) shows the Co-polar plot of RDRA without the graphene layers. The result of the Co-polar and Cross-polar shows the good signal detection capability of antenna. The main lobe magnitude is 9.79 dB in the RDRA with graphene layer and 9.99 dB in the RDRA without graphene layer.

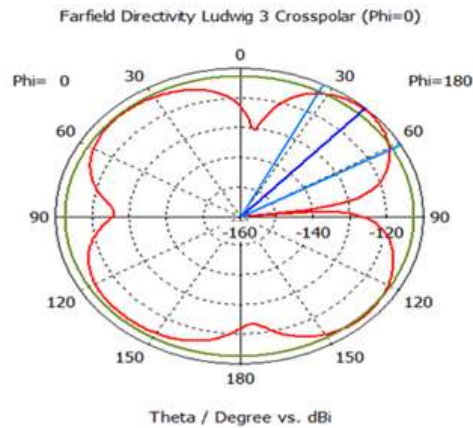
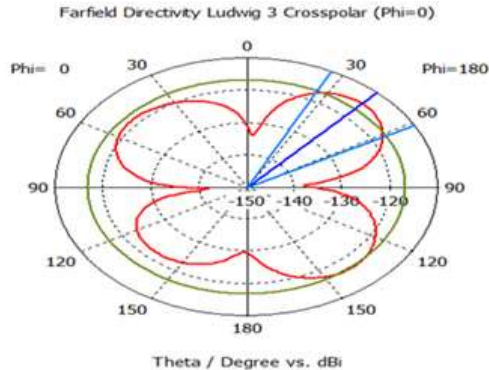
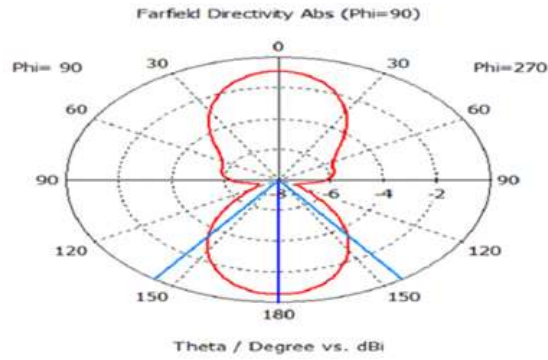
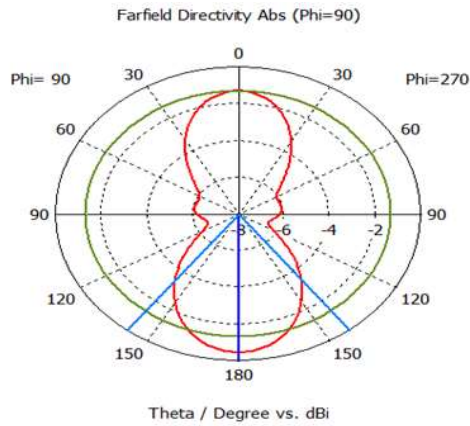

Figure 8: Cross-Polar Plot of RDRA (a) with graphene layer (b) without graphene layer

Figure 8 illustrates the Cross-polar plot of the RDRA with the graphene layers and without the graphene layers. Figure 8(a) shows the Cross-polar plot of RDRA with the graphene layers and Figure 8(b) shows the Cross-polar plot of RDRA without the graphene layers. Cross polarization means when the polarization of both the antennas is different. The angular width is 35.5 degree in the RDRA with graphene layer and 33.7 degree in the RDRA without graphene layer.



(a)



(b)

Figure 9: Directivity at H-plane (a) with graphene layer (b) without graphene layer

The Directivity at H-plane is shown in Figure 9. Directivity of an antenna is defined as the ratio of the radiation intensity in a given direction from the antenna to the radiation intensity averaged over all directions. The observation of H-field and E-field distribution helps in recognizing the tunability of the antenna. The H-plane containing magnetic field vector and the direction of maximum radiation. In the H-field parameter, the angular width of directivity at H-plane with the graphene layer is 73.2 degree as shown in Figure 9(a), and directivity in the RDRA without graphene layer is 75.1 degree as shown in Figure 9(b).

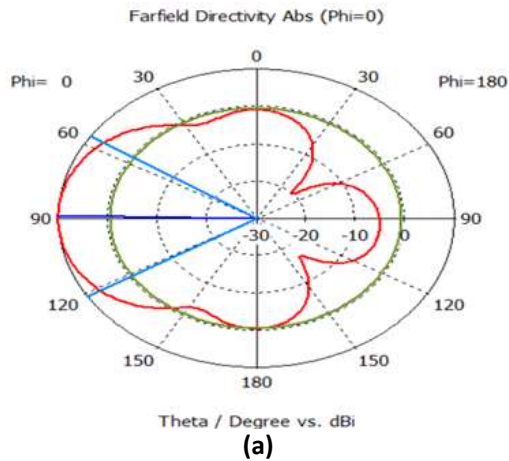

(a)

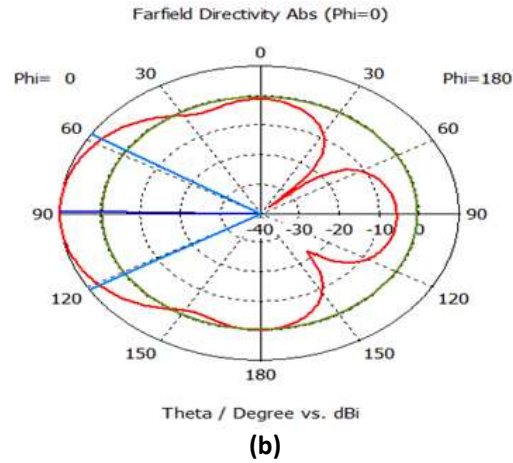

Figure 10: Directivity at E-plane (a) with graphene layer (b) without graphene layer

The Directivity at E-plane is shown in Figure 10. Directivity of an antenna is defined as the ratio of the radiation intensity in a given direction from the antenna to the radiation intensity averaged over all directions. The E-plane is defined as the plane containing the electric field vector and the direction of maximum radiation. The observation of H-field and E-field distribution helps in recognizing the tunability of the antenna the value of main lobe magnitude of directivity at E-plane with the graphene layer is 9.86dB shows in Figure 10(a), and 9.95dB in the RDRA without graphene layer as shows in Figure 10(b).

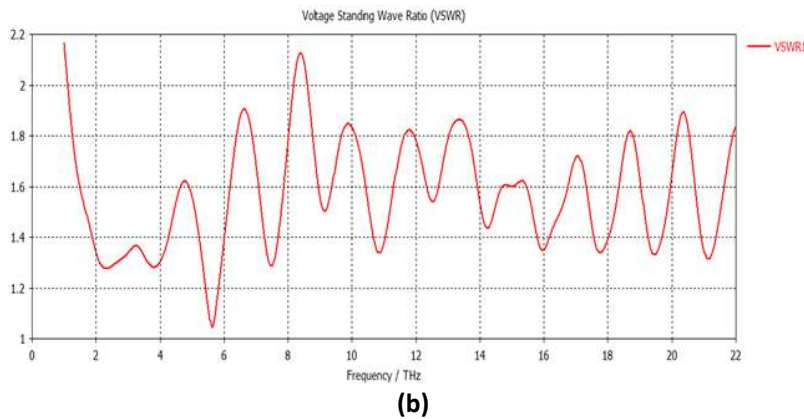
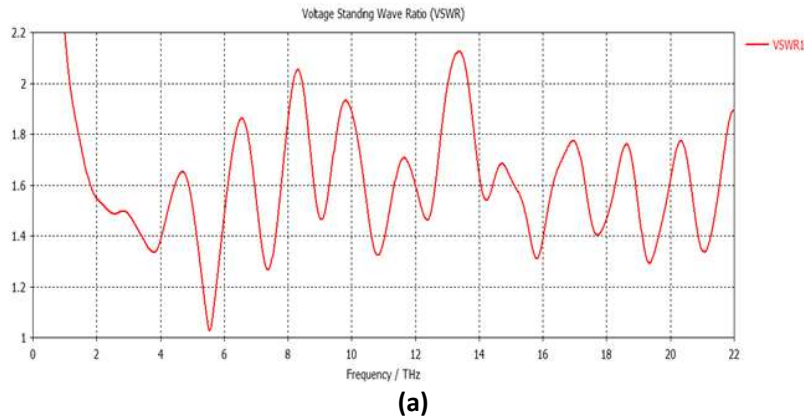

Figure 11: VSWR Vs Frequency plot (a) with graphene layer (b) without graphene layer

Figure.11 illustrates the VSWR (voltage standing wave ratio) and also refers to the standing wave ratio. VSWR is the function of the reflection coefficient, which describes the power reflected from the antenna. VSWR depends on the reflection coefficient (return loss) of the RDRA means the higher the reflection coefficient better the VSWR.

Figure 11(a) clearly shows the VSWR value as 1.027 at 5.535 THz frequency for the rectangular dielectric resonator antenna with rectangular graphene layer, and Figure 11 (b) shows the VSWR value as 1.047 at 5.62 THz for the rectangular dielectric resonator antenna without rectangular graphene layer. VSWR shows that the antenna perfectly matches with desired result and the desired application.

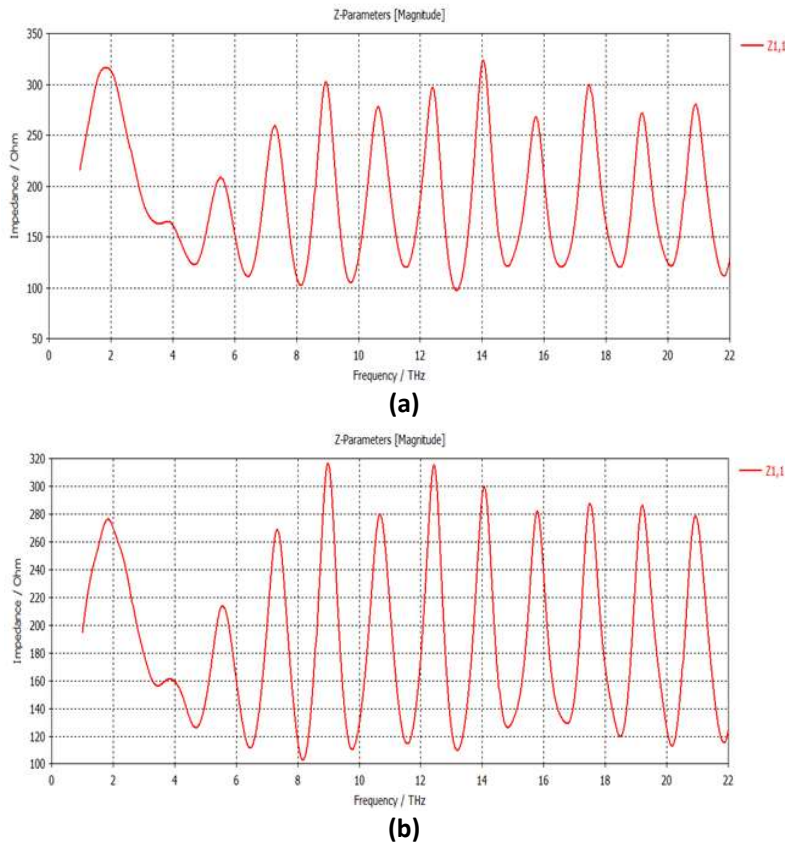
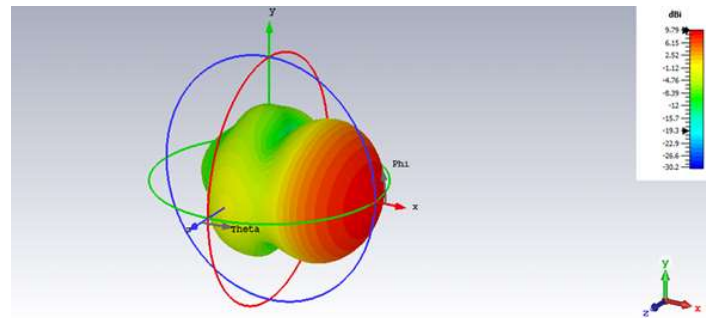
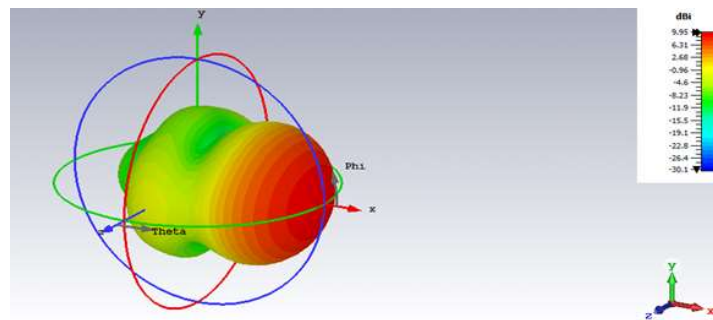

Figure 12: Z11 parameter of RDRA (a) with graphene layer (b) without graphene layer

Figure 12 shows the Z11 parameter of RDRA, Figure 12 (a) shows the Z11 parameter for RDRA with rectangular graphene layer, Fig.12 (b) shows the Z11 parameter for RDRA without graphene layer. Z11 is input impedance at a particular frequency which is defined as voltage and the current ratio of antenna. The Z11 parameter with the graphene layer is 209 Ohm and the Z11 parameter without the graphene layer is 212 Ohm. Which shows near to similar result in both the cases and providing desired input impedance for RDRA.



(a)



(b)

Figure 13: 3D Radiation Pattern of RDRA (a) with graphene layer (b) without graphene layer

Figure 13 shows the 3D radiation pattern of the rectangular dielectric resonator antenna. Figure 13(a) shows the 3D radiation pattern of the rectangular dielectric resonator antenna with a rectangular graphene layer, Figure 13(b) shows the 3D radiation pattern of the rectangular dielectric resonator antenna without a rectangular graphene layer.

3-D radiation pattern plot with and without the graphene layer is showing in Figure 13. Directivity of the antenna with graphene layer is 9.79 dB and without the graphene layer is 9.95 dB. This shows that the antenna transmits and receives information from all directions. The top shows the mandate example of a horn radio antenna, the base shows the omnidirectional example of a basic vertical receiving antenna. Radiation pattern are diagrammatical portrayals of the circulation of emanated energy into space, as an element of bearing.

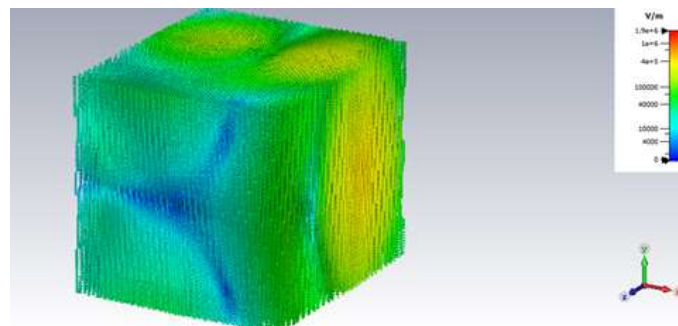

(a)

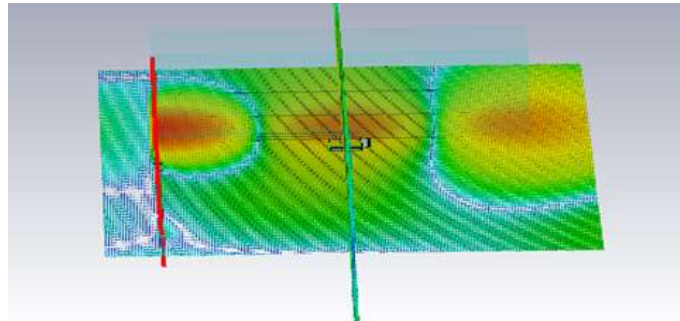

(b)

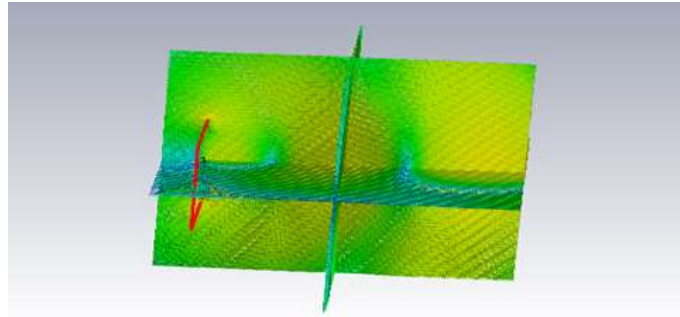

(c)

Figure 14: E-field distribution of RDRA

The E-field and H-field distribution is shown in Figure 14 and Figure 15 which shows the radiation mechanism of DRA can be obtained by observing the E-Field and H-Field distribution. Generation of hybrid modes is also obtained by observing it. E-field distribution show there are eight quadruple of E-field in the RDRA. H-Field distribution shows vertical electrical quadruple surrounded by the horizontal rectangular layer. After observing it is concluded that there are four vertical electrical dipoles is generated which shows that antenna operates in desire mode (HEM_{41δ}).

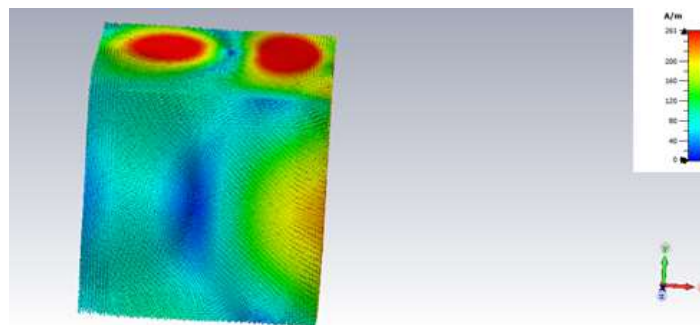

(a)

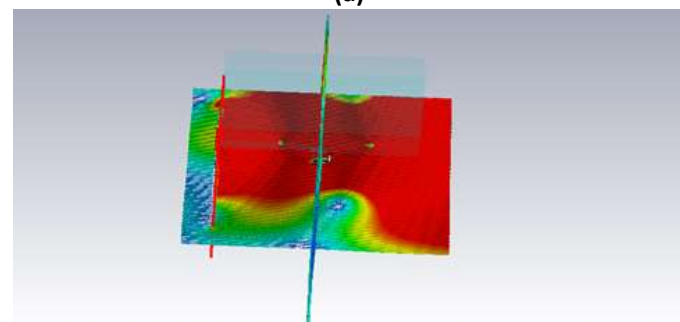

(b)

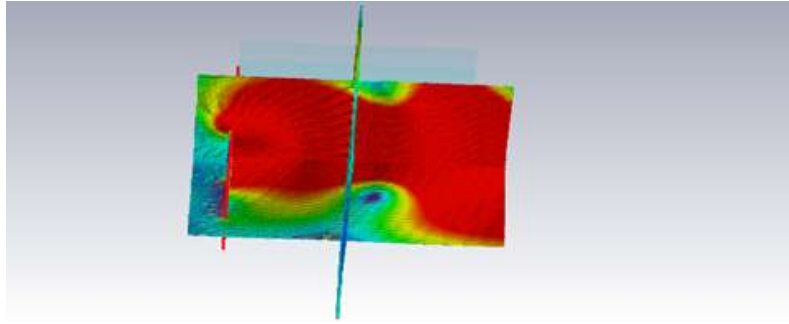

(c)

Figure 15: H-Field Distribution of RDRA

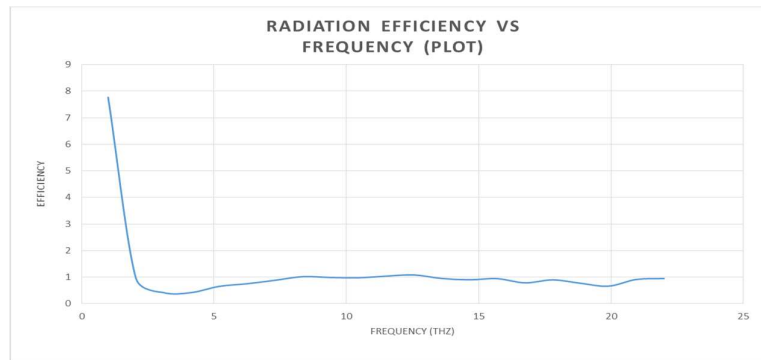

(a)

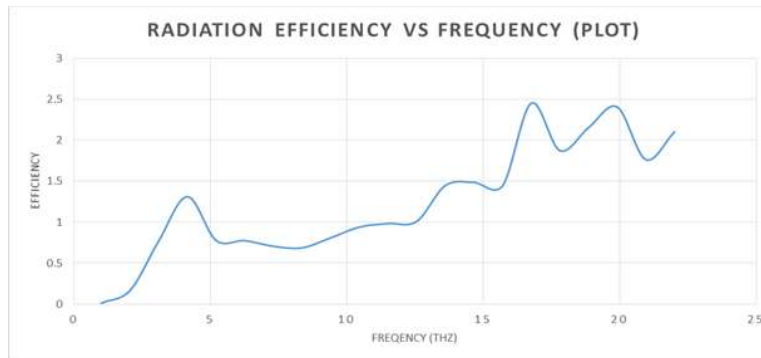

(b)

Figure 16: Radiation efficiency (a) with graphene layer (b) without graphene layer

Figure 16 shows the efficiency versus frequency plot for the RDRA. Figure 16 (a) shows the RDRA with graphene layer provides Efficiency of 78.3% on operating frequency band. The Figure 16 (b) shows the 75% efficiency of the rectangular dielectric resonator antenna without rectangular graphene layer.

4. Conclusion

In this paper, the authors analyze and simulate RDRA (rectangular dielectric resonator antenna) for 5G application. The Frequency response of RDRA is improved by changing the chemical potential of the rectangular graphene layer placed on the sides of the rectangular dielectric resonator. THz rectangular dielectric resonator antenna without rectangular graphene layer has 4.998 dB gain 75%

radiation efficiency. The performance parameter is increased in the RDRA with graphene layer, it provides 5.082 dB gain and radiation efficiency up to 78% -89% with the tunable THz frequency response.

5. Acknowledgements

The authors are thankful to Galgotia's College of Engineering and Technology for supporting this work. And also like to thank Mr. Atul Kumar, under whose guidance this work is done, they taught us the new concepts related to our work and various methods of improving the parameters .and also thank Mr. Saurabh katiyar for suggesting various improvement in our work.

6. References

- [1] Gaurav Varshney. "Tunable Terahertz Dielectric Resonator Antenna" springer Nature B.V. 2020.
- [2] M. A. H. Ashaari., M. S. S. Hassan., H. Yon and R. A. Awang. "Dual Band Rectangular Dielectric Resonator Antenna for Wireless Communication", 2018 IEEE International RF and Microwave Conference (RFM), (2018).
- [3] Ankit Kumar Roy & Sukla Basu. "Broadband, High Gain, Narrow Width Rectangular Dielectric Resonator Antenna With Air Gap", Journal of Electronic Science And Technology, Vol.17, No.1, March (2019).
- [4] Anuj Kumar Sahoo., Ravi Dutta Gupta & Manoj Singh Parihar. "Dual Band Circularly Polarized Dielectric Resonator Antenna for X-Band Application", 2018 3rd International Conference on Microwave and Photonics (ICMAP 2018), 9-11 February, (2018).
- [5] Syeda Hiba Hussain Mashhadi., Muhammad Wasif Niaz.,Yong-Chang Jiao and Jingdong Chen. "Broadbeam Coplanar-Parasitic Rectangular Dielectric Resonator Antenna", Electromagnetics Research M, vol. 81, 55-66, (2019).
- [6] Gaurav varshney., Rakesh singh.,Vinay S. Pandey and Rajveer S.Yaduvanshi. "Circularly Polarized Two-Port MIMO Dielectric Resonator Antenna", Electromagnetic research M, vol.91 (2020).
- [7] Ladislau Matekovits., Homayoon Oraizi and Saeed Fakhte. "High Gain Rectangular Dielectric Resonator Antenna using Uniaxial Material at Fundamental Mode", IEEE Transactions on Antennas and Propagation, vol. 65, no.1, January 2017.
- [8] Harish Ravichandran., E. Vinodha. "An Aperture Coupled Rectangular Dielectric Resonator Antenna For Dual-Band Application", 2019 IEEE International Conference on Electric, Computer and Communication Technologies (ICECCT), (2019).
- [9] Md. Muzammil Sani., Rakesh Chowdhury., Raghvendra Kumar Chaudhary. "An Ultra-Wideband Rectangular Dielectric Resonator Antenna with MIMO Configuration", IEEE Access, (2020).
- [10] Prof. Kaushik Vipul., Dr. Jagruti R. Panchal. "Dielectric Resonator Antenna and its Design Parameters A Review", International Research Journal of Advanced Engineering and Science, vol.2, no.4, PP. 123-133 Nov (2017).