

Orbital Debris Quarterly News

Volume 21, Issue 4
November 2017

Inside...

Projected GEO Survey Capabilities of the Meter Class Eugene Stansbery Orbital Debris Telescope 2

Abstracts from the NASA Orbital Debris Program Office 5

Abstracts from the HVIT Group 7

Conference and Meeting Reports 8

ODQN Vol. 21 Updates and Errata 11

Space Missions and Satellite Box Score 12



A publication of the NASA Orbital Debris Program Office

Latest SOZ Breakup Occurs in September 2017

A SOZ (*Sistema Obespecheniya Zapuska*) ullage motor, or SL-12 auxiliary motor, from a Proton Block DM fourth stage fragmented at 2:37Z on 3 September 2017. These motors have a long history of fragmentations, this event being the 47th breakup of this class of object over its program history and the first since July 2016. A total of 380 SL-12 auxiliary motors have been cataloged between 1970 and 2012, of which 64 remain on orbit. Of these 64, 37 are now believed to be intact. The remaining 27 have fragmented and remain on-orbit while an additional 20 fragmented parent bodies are no longer on orbit.

Ullage motors, used to provide three-axis control to the Block DM during coast and to settle propellants prior to an engine restart, are routinely ejected after the Block DM stage ignites for the final time. This SOZ unit (International Designator 2010-041G, U.S. Strategic Command [USSTRATCOM] Space Surveillance Network [SSN] catalog number 37143) is associated with the launch of the Cosmos 2464-2466 spacecraft, members of the Russian global positioning

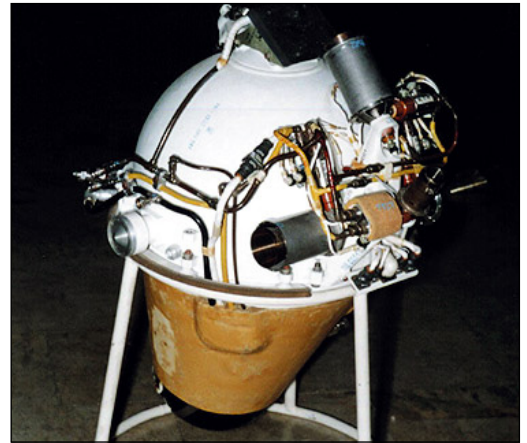

Figure 1. An 11D79 SOZ unit; nozzle assembly not installed. Photo credit: RKK Energia/Kosmonavtika.com.

navigation system (GLONASS) constellation.

The unit fragmented into multiple pieces, though none have entered the SSN catalog as of 5 October

continued on page 2

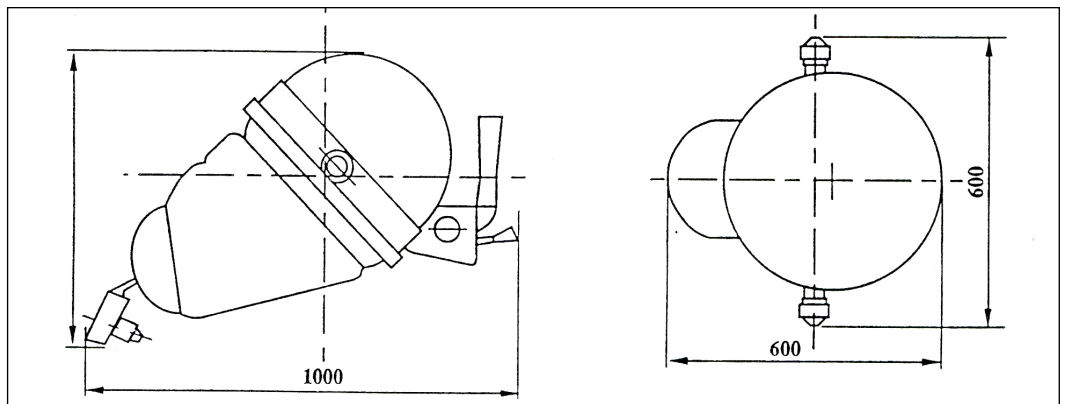

Figure 2. Plan views of a SOZ unit; all dimensions are in millimeters. Dry mass is 56 kg. Illustration from N. L. Johnson, "History of Soviet/Russian Satellite Fragmentations - A Joint US-Russian Investigation," Kaman Sciences Corporation, USA, October 1995, p. 19.

SOZ Breakup

continued from page 1

2017. The motor was in a highly elliptical 18684 x 756 km orbit at an inclination of 65.2° at the time of the breakup; the event is estimated to have occurred at an altitude of approximately 14836.6 km at a latitude of 55.1° South and longitude of 155.2° East. Due to difficulties in tracking objects in deep space elliptical orbits, this event may have produced many fragmentation debris.

Interestingly, this is the second SOZ unit whose fragmentation was predicted by analysts of the Air Force Space Command 18th Space Control Squadron [1]. Their analysis indicates that SOZ units experience outgassing prior to the fragmentation event; the main body of the SOZ can then exhibit the effects of outgassing for several days after the event. This new analytical technique is useful in prompting additional

surveillance of a SOZ unit prior to and post-fragmentation and assessing event time for modeling and risk assessment purposes.

Reference

1. Slatton, Z., and McKissock, D. "Methods of Predicting and Processing Breakups of Space Objects," presented at the 7th European Conference on Space Debris, Darmstadt, Germany, April 2017. ♦

PROJECT REVIEW

Projected GEO Survey Capabilities of the Meter Class Eugene Stansbery Orbital Debris Telescope

JAMES FRITH

Until recently, the NASA Orbital Debris Program Office's (ODPO) primary optical asset was the 0.6-m Michigan Orbital Debris Survey Telescope (MODEST), located at the Cerro Tololo Inter-American Observatory in Chile (see Fig. 1). MODEST regularly conducted surveys of the GEO environment to estimate the population and size of the debris near GEO. By imaging a field of view (FOV) placed at a Right Ascension (RA) and Declination (Dec) near the anti-solar point, illumination conditions were maximized such

that any object passing through the FOV would be fully illuminated by the Sun (similar to the full Moon). Throughout several years of observing, these FOVs were stacked on top of each other in Dec in order to more completely sample the GEO region and detect debris with various inclinations (INC) and Right Ascensions of Ascending Nodes (RAAN), as shown in Fig. 2.

To quantitatively determine the observational coverage of the INC/RAAN space, ODPO developed code that predicts the Expectation Value (EV) of coverage (formerly referred to

as "probability of coverage"). The EV is defined as the fraction of time during an orbit that the telescope system would observe a simulated target with a given INC and RAAN. The computer code predicts what INC/RAAN-space a telescope can observe given the telescope site and system, observational date, universal time (UT), RA, and geocentric latitude. A field center (FC) is generated for each INC/RAAN pointing.

An angular state vector (SV[FC]) to the field center from the telescope is calculated based on the given parameters. To sample the

INC/RAAN space, a series of simulated GEO orbits (mean motion = 1.0027 rev/day, $a=42,164.2$ km, eccentricity = 0) are calculated by varying the INC values from 0 to 30 degrees in steps of one degree for each value of RAAN between 0 and 360 degrees in steps of 0.25 degree. Target State Vectors (TSVs[INC/RAAN]) are then calculated for each telescope pointing and INC/RAAN pair.

The code compares the fields defined by the field center positions by using the FOV of the



Figure 1. The MODEST telescope located in Cerro Tololo Chile.

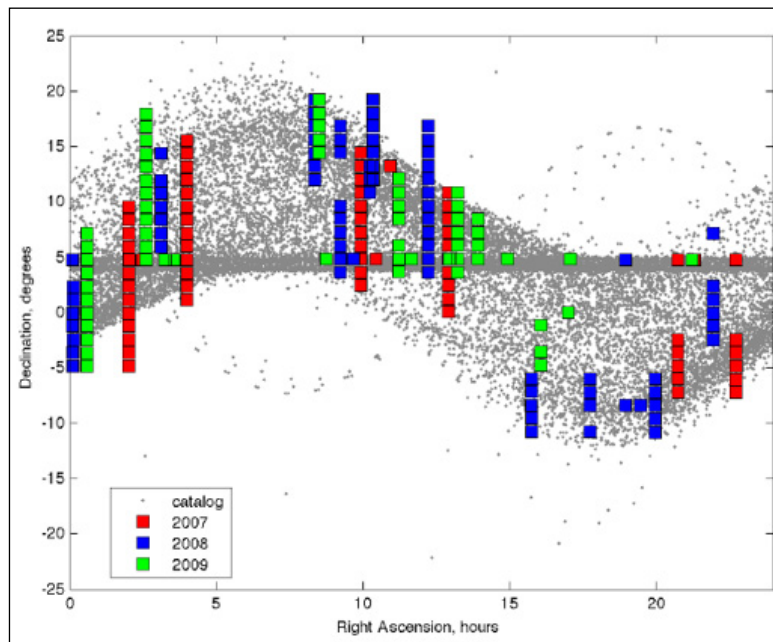

Figure 2. Fields of view (FOVs) covered by the MODEST telescope from 2007 to 2009.

continued on page 3

GEO Survey Capabilities

continued from page 2

camera system with the positions of the targets generated along the simulated orbits. The FOV is defined as the super-scribed circle for square CCD arrays or the super-scribed ellipse for rectangular CCDs using the average of the x, y dimensions. The criteria for detection of a simulated target is defined as four consecutive camera frames where the angular distances between SV(FC) and TSV(INC/RAAN) are smaller in both X (angular distance, ϕ) and Y (angular distance θ) as defined by the FOV. If both angles are less than their corresponding CCD dimension, the target is considered detected. If the target is found within four consecutive fields and within the rate box (± 5 arcsec in RA and ± 2 arcsec in DEC), then a detection is recorded.

The program calculates the EV that the telescope system observed for a particular INC/RAAN as defined by the simulated target. The EV of detection is quantitatively defined as the sum of detections divided by 1000 within a given FC. The EV is scaled to 1000, thus assuming there were 1000 possible detections along the ~ 24 -hour orbit defined by a mean motion of 1.0027 rev/day. This scaling number could be increased, but would very significantly increase the computational time.

Fig. 3 shows an example of the EV to define the observational coverage. If the EV is equal to 1.0, then the observational coverage is complete and all simulated orbits defined by an INC/RAAN pair have been detected. If EV is greater than 1.0 then the observational coverage is over sampled.

The EV value is color-coded and scaled to 1.0. The detections by MODEST are noted by black dots for objects correlated with the Space Surveillance Network (SSN) catalogue (correlated targets, or CTs) and open circles for targets that could not be correlated with a catalogued object (uncorrelated targets, or UCTs). These detections demonstrate the natural orbital oscillations experienced by UCTs, varying from 0 to 15 deg INC as seen in INC vs. RAAN space, as proposed by Friesen [1].

Due to the short orbital arc over which observations are made, the eccentricity of the object's orbit is extremely difficult to calculate accurately. Therefore, a circular orbit was assumed when calculating the orbital elements.

The NASA Eugene Stansbery Meter Class Autonomous Telescope (ES-MCAT) is scheduled to be fully operational by approximately October 2018, making it NASA's newest operational asset for orbital debris surveys. The goal of this exercise was to determine the amount of observational coverage required to reach $EV \geq 1.0$ across the GEO region of interest using the observational characteristics of ES-MCAT. To achieve this, a series of preliminary prediction simulations have been run for ES-MCAT's site and instrumentation to determine what observational coverage is needed to reach a value of $EV \geq 1$ for regions of interest in the INC vs. RAAN space. These simulations have been run using the same model described above.

The following assumptions were used for the

simulations:

- Observational campaigns consisted of 23 nights per month centered on the new moon (avoiding the week of full-moon);
- Two RA regions were observed each night: 1 hour east of the anti-solar point and 1 hour west of the anti-solar point;
- Each RA region was observed for 4 hours per night; and
- GEO DECs were chosen each night to cover the band of catalogued GEO objects.

Fig. 4 illustrates the cataloged GEO targets as dots and the ES-MCAT FOV (0.68°) as red squares. In general, 23 FOVs (or 23 GEO declinations) are necessary to cover the GEO band. Thus, the choice of 23 observing nights per month was accurate. In some cases near the maxima/minima of the GEO band, 26 FOVs were required and additional nights were added to the simulation for that month's period. It was assumed that the FOVs did not overlap.

Using the above assumptions and methods, several simulations were performed to determine the orbital coverage resulting from different observing strategies with the goal of producing a complete GEO belt survey. An initial 1-month simulation covered only a portion of the INC vs. RAAN space, thus additional months were added to increase the coverage, including surveys lasting 4, 5, and 6 months.

continued on page 4

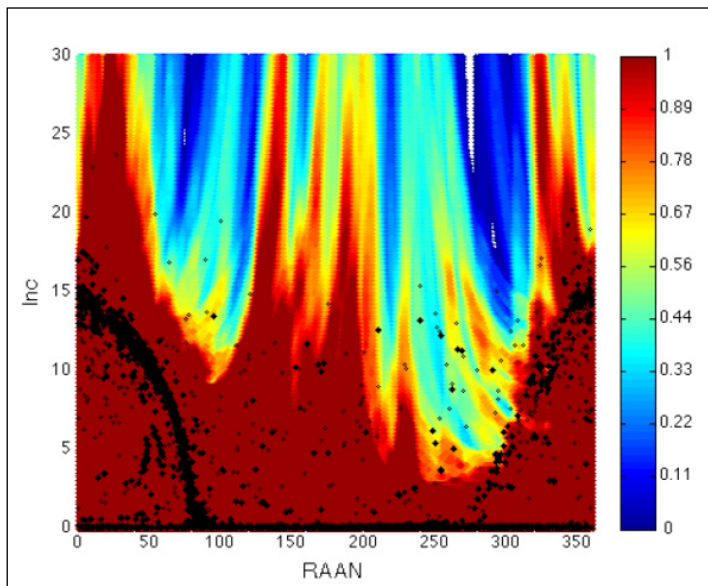

Figure 3. Expectation value (EV) of finding specific orbits (INC vs. RAAN, or Inclination vs. Right Ascension of Ascending Node pairs) based on field center (FC) location during the 2007-2009 MODEST observing.

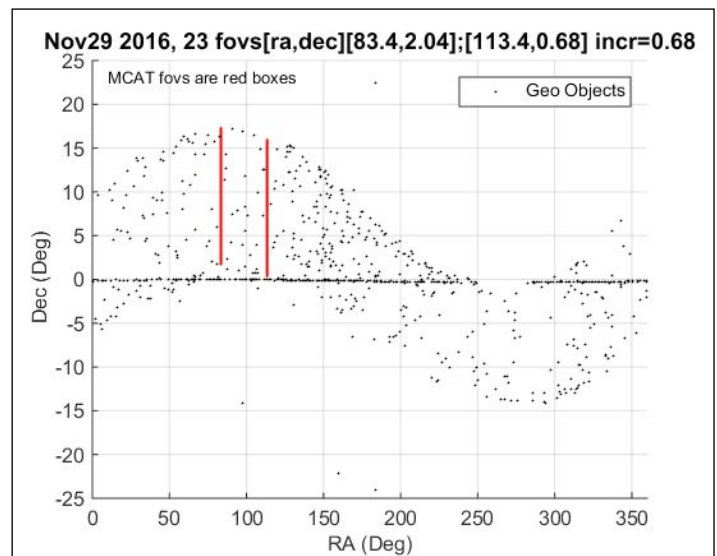

Figure 4. The distribution of cataloged GEO objects for 29 November 2016. Twenty-three FOVs are stacked (appearing as two red bars) representing the pointings in RA of the telescope on a given night, one preceding and the other following the anti-solar point. Up to 26 FOVs can be required for the regions that are wider in Dec space (e.g., RA $\sim 80^\circ$).

GEO Survey Capabilities

continued from page 3

Simulated observation campaigns described above were performed once per quarter during 2016 centered on the new moon dates of 8 March, 5 June, 1 September, and 29 November. A plot of the simulation results can be seen in Fig. 5. A color bar to the right of the main plot shows the EV value as it corresponds to a particular color. Significant gaps in the coverage, primarily above 100°, 225°, and 310°, are easily seen as white regions. These

regions represent the INC vs. RAAN locations that were not sampled using this observation strategy, which demonstrates this approach's shortcomings. The coverage between RAAN=90° and 270° is well below the desired value of EV = 1.0.

Another simulation was performed covering a 5-month period centered on the new moons in February, March, April, May, and June of 2016. These results can be seen in Fig. 6. This simulation

resulted in a more complete spatial coverage (no white gaps, which represent orbital regimes that were not observed). However, there are many regions where the EV value is less than one. This can be seen near the 150° to 200° RAAN values.

Adding an additional month (6-month total) to the simulated observations shown in Fig. 6 produced a very similar plot. To check for seasonal effects, a simulation was carried out for a time period of 6 months, covering the new moons in July, August, 1 September, 30 September, October,

and November. The resultant coverage can be seen in Fig. 7. Coverage is complete and very smooth and all densely populated regions of the GEO belt (see plotted data points in Fig. 2) are at or near an EV value of 1.0.

Based solely on the simulations described herein, a 5- to 6-month campaign will provide EV coverage ≥ 1.0 for nearly all regions of the INC vs. RAAN orbital space. However, these simulations have not considered important factors such as:

- Weather causing gaps in the 23 nights of continuous observational coverage;
- Effects of moonlight interference, which reduces the sensitivity of the camera system;
- Effects of observing within the galactic plane, which can add to the number of false detections; and
- Simulation assumptions that the anti-solar point was static from night to night instead of the actual slight movement in RA each night. This effect will broaden the coverage necessary in RAAN.

These effects are likely to increase the total time needed to produce a complete survey of the GEO region and will be the subject of future work.

Reference

Friesen, L., *et al.*, "Results in Orbital Evolution of Objects in the Geosynchronous Region," AIAA 90-1362, AIAA/NASA/DOD Orbital Debris Conference: Technical Issues and Future Directions, Baltimore, MD, 1990. ♦

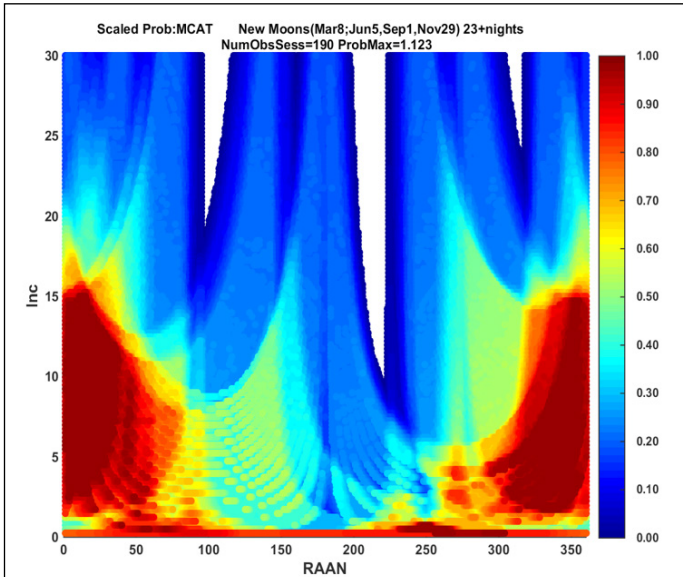

Figure 5. Four months sampled on a quarterly basis. The maximum EV here is 1.123. The white regions represent orbits that are not sampled using this method (EV=0). There are also highly populated orbits that are observed with this strategy, but not fully sampled (i.e., where the EV is less than 1.0), implying this simulation scenario is not sufficient.

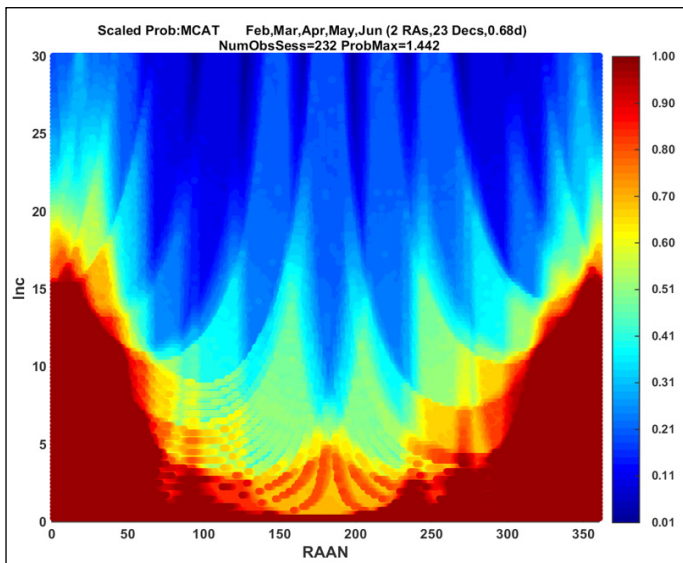

Figure 6. GEO orbits sampled and EV values for observations during a 5-month, consecutive period with an increased maximum EV of 1.442. The un-sampled white regions are no longer present, but there are still densely populated orbits that are under-sampled (have an EV < 1.0).

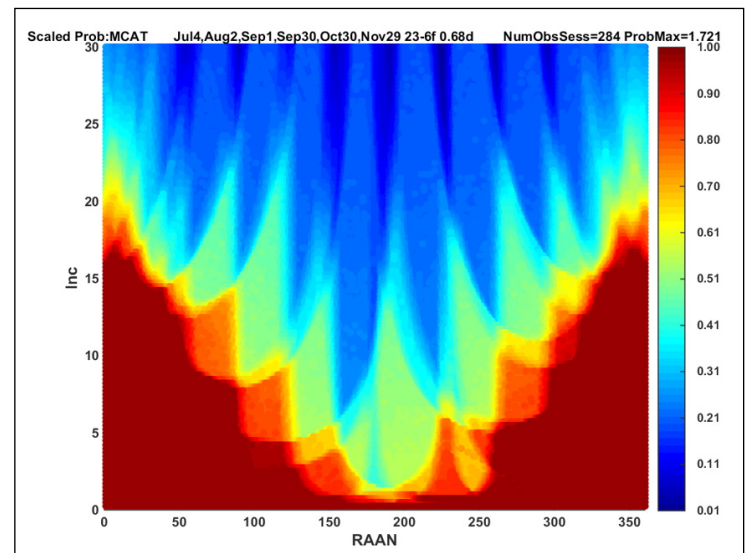

Figure 7. The GEO coverage as shown in the previous figures, but covering a 6-month consecutive period beginning in July 2016 and an expectation value increasing here to 1.7 (versus 1.123 in Fig 5, and 1.442 in the previous figures; this variation in maximum EV skews the color coding slightly for direct comparison from one plot to the next). Notably, there are no un-sampled regions and the coverage is more smoothly sampled than in Fig. 5 or 6.

ABSTRACTS FROM THE NASA ORBITAL DEBRIS PROGRAM OFFICE

The 18th Advanced Maui Optical and Space Surveillance Technologies Conference (AMOS),
19-22 September 2017, Maui, Hawaii

Characterizing GEOTitan IIICTranstage Fragmentations using Ground-based and Telescopic Measurements

H. COWARDIN, P. ANZ-MEADOR, AND
J. REYES

In a continued effort to better characterize the geosynchronous orbit (GEO) environment, NASA's Orbital Debris Program Office (ODPO) utilizes various ground-based optical assets to acquire photometric and spectral data of known debris associated with fragmentations in or near GEO. The Titan IIIC Transtage upper stage is known to have fragmented four times. Two of the four fragmentations were in GEO while the Transtage fragmented a third time in GEO transfer orbit. The fourth fragmentation occurred in low Earth orbit.

To better assess and characterize these

fragmentations, the NASA ODPO acquired a Titan Transtage test and display article previously in the custody of the 309th Aerospace Maintenance and Regeneration Group (AMARG) in Tucson, Arizona. After initial inspections at AMARG demonstrated that it was of sufficient fidelity to be of interest, the test article was brought to NASA Johnson Space Center (JSC) to continue material analysis and historical documentation. The Transtage has undergone two separate spectral measurement campaigns to characterize the reflectance spectroscopy of historical aerospace materials. These data have been incorporated into the NASA Spectral Database, with the goal of using

telescopic data comparisons for potential material identification. A Light Detection and Ranging (LIDAR) system scan also has been completed and a scale model has been created for use in the Optical Measurement Center (OMC) for photometric analysis of an intact Transtage, including bidirectional reflectance distribution function (BRDF) measurements.

An historical overview of the Titan IIIC Transtage, the current analysis that has been done to date, and the future work to be completed in support of characterizing the GEO and near GEO orbital debris environment will be discussed in the subsequent presentation. ♦

Space Weathering Experiments on Spacecraft Materials

D. ENGELHART, R. COOPER, H. COWARDIN,
J. MAXWELL, E. PLIS, D. FERGUSON,
D. BARTON, S. SCHIEFER, AND R. HOFFMANN

A project to investigate space environment effects on specific materials with interest to remote sensing was initiated in 2016. The goal of the project is to better characterize changes in the optical properties of polymers found in multi-layered spacecraft insulation (MLI) induced by electron bombardment. Previous analysis shows that chemical bonds break and potentially reform when exposed to high energy electrons like

those seen in orbit. These chemical changes have been shown to alter a material's optical reflectance, among other material properties. This paper presents the initial experimental results of MLI materials exposed to various fluences of high energy electrons, designed to simulate a portion of the geosynchronous Earth orbit (GEO) space environment. It is shown that the spectral reflectance of some of the tested materials changes as a function of electron dose. These results provide an experimental benchmark for analysis of aging effects on satellite systems which can

be used to improve remote sensing and space situational awareness. They also provide preliminary analysis on those materials that are most likely to comprise the high area-to-mass ratio (HAMR) population of space debris in the geosynchronous orbit environment. Finally, the results presented in this paper serve as a proof of concept for simulated environmental aging of spacecraft polymers that should lead to more experiments using a larger subset of spacecraft materials. ♦

Characterizing the Survey Strategy and Initial Orbit Determination Abilities of the NASA MCAT Telescope for Geosynchronous Orbital Debris Environmental Studies

J. FRITH, E. BARKER, H. COWARDIN,
B. BUCKALEW, P. ANZ-MEADOR, AND
S. LEDERER

The National Aeronautics and Space Administration (NASA) Orbital Debris Program Office (ODPO) recently commissioned the Meter Class Autonomous Telescope (MCAT) on Ascension Island with the primary goal of obtaining population statistics of the geosynchronous (GEO) orbital debris environment. To help facilitate this,

studies have been conducted using MCAT's known and projected capabilities to estimate the accuracy and timeliness in which it can survey the GEO environment, including collected weather data and the proposed observational data collection cadence. To optimize observing cadences and probability of detection, on-going work using a simulated GEO debris population sampled at various cadences are run through the Constrained Admissible Region Multi Hypotheses Filter

(CAR-MHF). The orbits computed from the results are then compared to the simulated data to assess MCAT's ability to determine accurately the orbits of debris at various sample rates. The goal of this work is to discriminate GEO and near-GEO objects from GEO transfer orbit objects that can appear as GEO objects in the environmental models due to the short arc observation and an assumed circular orbit. The specific methods and results are presented here. ♦

NASA's Optical Program on Ascension Island: Bringing MCAT to Life as the Eugene Stansbery-Meter Class Autonomous Telescope (ES-MCAT)

S. LEDERER, P. HICKSON, H. COWARDIN, B. BUCKALEW, J. FRITH, AND R. ALLISS

In June 2015, the construction of the Meter Class Autonomous Telescope was completed and MCAT saw the light of the stars for the first time. In 2017, MCAT was newly dedicated as the Eugene Stansbery-MCAT telescope by NASA's Orbital Debris Program Office (ODPO), in honor of his inspiration and dedication to this newest optical member of the NASA ODPO. Since that time, MCAT has viewed the skies with one engineering camera and two scientific cameras, and the ODPO optical team has begun the process of vetting the entire system.

The full system vetting includes verification and validation of: (1) the hardware comprising the system (e.g. the telescopes and its instruments, the dome, weather systems, all-sky camera, FLIR cloud infrared camera, etc.), (2) the custom-written Observatory Control System (OCS) master software designed to autonomously control this complex system of instruments, each with its own control software, and (3) the custom-written Orbital Debris Processing software for post-processing the data.

ES-MCAT is now capable of autonomous observing to include Geosynchronous survey, TLE (Two-line element) tracking of individual

catalogued debris at all orbital regimes (Low-Earth Orbit all the way to Geosynchronous (GEO) orbit), tracking at specified non-sidereal rates, as well as sidereal rates for proper calibration with standard stars.

Ultimately, the data will be used for validation of NASA's Orbital Debris Engineering Model, ORDEM, which aids in engineering designs of spacecraft that require knowledge of the orbital debris environment and long-term risks for collisions with Resident Space Objects (RSOs). ♦

The 9th International Association for the Advancement of Space Safety (IAASS) Conference, 18-20 October 2017, Toulouse, France

Oblate-Earth Effects on the Calculation of E_c During Spacecraft Reentry

J. BACON AND M. MATNEY

The bulge in the Earth at its equator has been shown [1] to lead to a clustering of natural decays biased to occur towards the equator and away from the orbit's extreme latitudes. Such clustering must be considered when predicting the Expectation of Casualty (E_c) during a natural decay because of the clustering of the human population in the

same lower latitudes. This study expands upon prior work [1, 2], and formalizes the correction that must be made to the calculation of the average exposed population density as a result of this effect. Although a generic equation can be derived from this work to approximate the effects of gravitational and atmospheric perturbations on a final decay, such an equation averages certain important subtleties

in achieving a best fit over all conditions. The authors recommend that direct simulation be used to calculate the true E_c for any specific entry as a more accurate method. A generic equation is provided, represented as a function of ballistic number and inclination of the entering spacecraft over the credible range of ballistic numbers. ♦

Improving Estimation of Ground Casualty Risk from Reentering Space Objects

C. OSTROM

A recent improvement to the long-term estimation of ground casualties from reentering space debris is the further refinement and update to the human population distribution. Previous human population distributions were based on global totals with simple scaling factors for future years, or a coarse grid of population counts in a subset of the world's countries, each cell having its own projected

growth rate. The newest population model includes a 5-fold refinement in both latitude and longitude resolution. All areas along a single latitude are combined to form a global population distribution as a function of latitude, creating a more accurate population estimation based on non-uniform growth at the country and area levels.

Previous risk probability calculations used simplifying assumptions that did not account

for the ellipsoidal nature of the Earth. The new method uses first, a simple analytical method to estimate the amount of time spent above each latitude band for a debris object with a given orbit inclination and second, a more complex numerical method that incorporates the effects of a non-spherical Earth. These new results are compared with the prior models to assess the magnitude of the effects on reentry casualty risk. ♦

The 68th International Astronautical Congress (IAC), 25-29 September 2017, Adelaide, Australia

Imaging Systems for Size Measurements of DebrisSat Fragments

B. SHIOTANI, T. SCRUGGS, R. TOLEDO, N. FITZ-COY, J.-C. LIU, M. SORGE, T. HUYNH, J. OPIELA, P. KRISKO, AND H. COWARDIN

The overall objective of the DebrisSat project is to provide data to update existing standard spacecraft breakup models. One of the key sets of parameters used in

these models is the physical dimensions of the fragments (i.e., length, average-cross sectional area, and volume). For the DebrisSat project, only fragments with at least one dimension greater than 2 mm are collected and processed. Additionally, a significant portion of the fragments recovered from the impact test are needle-like and/or flat

plate-like fragments where their heights are almost negligible in comparison to their other dimensions. As a result, two fragment size categories were defined: 2D objects and 3D objects. While measurement systems are commercially available, factors such as

continued on page 7

Imaging Systems for Size Measurements

continued from page 6

measurement rates, system adaptability, size characterization limitations and equipment costs presented significant challenges to the project and a decision was made to develop our own size characterization systems. The size characterization systems consist of two automated image systems, one referred to as the 3D imaging system and the other as the 2D imaging system. Which imaging system to use depends on the classification of the fragment being measured. Both imaging systems utilize point-and-shoot cameras for object image acquisition and create representative point clouds of the fragments. The 3D imaging system utilizes a space-carving algorithm

to generate a 3D point cloud, while the 2D imaging system utilizes an edge detection algorithm to generate a 2D point cloud. From the point clouds, the three largest orthogonal dimensions are determined using a convex hull algorithm. For 3D objects, in addition to the three largest orthogonal dimensions, the volume is computed via an alpha-shape algorithm applied to the point clouds. The average cross-sectional area is also computed for 3D objects. Both imaging systems have automated size measurements (image acquisition and image processing) driven by the need to quickly and accurately measure tens of thousands of debris fragments. Moreover, the

automated size measurement reduces potential fragment damage/mishandling and ability for accuracy and repeatability. As the fragment characterization progressed, it became evident that the imaging systems had to be revised. For example, an additional view was added to the 2D imaging system to capture the height of the 2D object. This paper presents the DebrisSat project's imaging systems and calculation techniques in detail; from design and development to maturation. The experiences and challenges are also shared. ♦

ABSTRACTS FROM THE NASA HVIT GROUP

The 7th European Conference on Space Debris, 18-21 April 2017, ESA/ESOC, Darmstadt, Germany

Shape Effect Analysis of Aluminum Projectile Impact on Whipple Shield

M.J. CARRASQUILLA AND J.E. MILLER

This report presents a numerical analysis study on the shape effects of prolate and oblate ellipsoid projectiles on the performance of spacecraft shields conducted in support of the Orbital Debris Program Office at the NASA Johnson Space Center with the Hypervelocity Impact Technology (HVIT) group [1]. The study served as an independent analysis of the experimental results obtained by the Ernst-Mach Institute, who conducted hypervelocity impact (HVI) tests using shaped-projectiles against a dual-wall Whipple shield to develop ballistic

limit equations (BLE) with shape effects. The HVI have been simulated via the three-dimensional, nonlinear-structural-dynamics, simulation tool, CTH, which has been developed by Sandia National Laboratories to treat shock-wave propagation and large-deformation phenomena. The results from the numerical simulations for the sphere and prolate ellipsoid projectiles indicate numerical simulations are a viable tool for conducting HVI analyses, however, significant differences between the CTH models and published EMI test data for the oblate projectiles point to issues in modeling the impact physics of oblate ellipsoid geometries

[2]. Consequently, further analysis should be performed to solve the problem in modeling these oblate projectile impacts. The unmodified BLE for spheres and modified BLE for prolate ellipsoids reasonably predict failure of a Whipple shield at low impact velocities, but based on the obtained data may need to be adjusted for velocities between 4 and 8 km/s. ♦

Published in *Procedia Engineering* 204 (2017) pp. 308-314. Available online at <http://www.sciencedirect.com/science/article/pii/S1877705817343059>

Hypervelocity Impact Testing of a Pressurized Composite Overwrapped Pressure Vessel and Comparison to Numerical Analysis

M.A. GARCIA, B.A. DAVIS, AND J.E. MILLER

As the outlook for space exploration becomes more ambitious and spacecraft travel deeper into space, it is increasingly important that systems with energetic material storage perform reliably within the space environment. Because hardware mass is limited, the use of high strength-to-weight Composite Overwrap Pressure Vessels (COPV) has enabled designers to store energy at a reduced mass penalty; however, because the composite overwrap carries a high fraction of the stress of pressurization, there is significant concern that

damage to the composite overwrap can lead to vessel failure and potentially cause loss-of-vehicle/loss-of-crew. One of the greatest external threats to the integrity of a spacecraft's COPV is an impact from the meteoroid and orbital debris environments (MMOD). Because the limited research regarding this problem cannot be generalized, the capacity for these vessels to tolerate such impacts is not well understood. This report details some of the early experimental efforts undertaken by the Hypervelocity Impact Technology (HVIT) group in the support of a NASA Engineering and Safety

Center (NESC) assessment to understand how hypervelocity impact conditions comparable to MMOD impacts initiate catastrophic COPV failure. In addition to this experimental work, this publication also reports on the development of a numerical method to guide the interpretation of the experimental data and extension to other flight relevant configurations. ♦

Published in *Procedia Engineering* 204 (2017) pp. 476-483. Available online at <http://www.sciencedirect.com/science/article/pii/S1877705817342984>

The 14th Hypervelocity Impact Symposium, 24-28 April, University of Kent, Canterbury, UK

Failure Mechanisms of Ni-H₂ and Li-Ion Batteries under Hypervelocity Impacts

J.E. MILLER, F. LYONS, E.L. CHRISTIANSEN, AND D.M. LEAR

Lithium-Ion (Li-Ion) batteries have yielded significant performance advantages for many industries, including the aerospace industry, and have been selected to replace nickel hydrogen (Ni-H₂) batteries for the International Space Station (ISS) to meet the energy storage demands. As the ISS uses its vast solar arrays to generate its power, the solar arrays meet their sunlit power demands and supply excess power to battery packs for

power delivery on the sun obscured phase of the approximate 90 minute low Earth orbit. These large battery packs are located on the exterior of the ISS, and as such, the battery packs are exposed to external environment threats like naturally occurring micrometeoroids and artificial orbital debris (MMOD). While the risks from these solid particle environments has been known and addressed to an acceptable risk of failure through shield design, it is not possible to completely eliminate the risk of loss of these assets on orbit

due to MMOD motivating a study into the failure consequences to the ISS. This paper documents the different failure modes for these two types of batteries under hypervelocity impact and the implications for spacecraft survivability when shielding is breached. ♦

Procedia Engineering 204 (2017) pp. 239-246. Available online at <http://www.sciencedirect.com/science/article/pii/S1877705817342856>

Orion Exploration Flight Test Post-flight Inspection and Analysis

J.E. MILLER, E.L. BERGER, W.E. BOHL, E.L. CHRISTIANSEN, B.A. DAVIS, K.D. DEIGHTON, P.A. ENRIQUEZ, M.A. GARCIA, J.L. HYDE, AND O.M. OLIVERAS

The principal mechanism for developing orbital debris environment models, is to make observations of larger pieces of debris in the range of several centimeters and greater using radar and optical techniques. For particles that are smaller than this threshold, breakup and migration models of particles to returned surfaces in lower orbit are relied upon to quantify the flux. This reliance on models to derive spatial densities of particles

that are of critical importance to spacecraft make the unique nature of the Exploration Flight Test 1 (EFT-1) return surface a valuable metric. To this end detailed post-flight inspections have been performed of the returned EFT-1 backshell, and the inspections identified six candidate impact sites that were not identified during the pre-flight inspections. This paper describes the post-flight analysis efforts to characterize the EFT-1 mission craters. This effort included ground based testing to understand small particle impact craters in the thermal protection material and multiple post-flight inspections. Crater analysis has

been performed using optical, X-ray computed tomography (CT) and scanning electron microscope (SEM) techniques. Finally, numerical simulations have been performed to bridge the gap between the ground based testing and the crater characterization findings. Each of these analyses are discussed here, along with, environment calculation implications. ♦

Procedia Engineering 204 (2017) pp. 460-467. Available online at <http://www.sciencedirect.com/science/article/pii/S1877705817342959>

CONFERENCE AND MEETING REPORTS

NASA-DOD Working Group 2017, 24 May 2017, NASA Johnson Space Center

The NASA-DOD Orbital Debris Working Group (ODWG) meeting was conducted 24 May 2017 by videoconference. This annual 1-day meeting reviews activities and research in orbital debris (OD) of mutual interest to both NASA and the Department of Defense (DOD). The ODWG originated in recommendations by interagency panels, who reviewed U.S. Government orbital debris activities in the late 1980s and early 1990s. This year's meeting marks the 20th anniversary of the series of meetings and was co-chaired by Dr. J.-C. Liou, NASA Chief Scientist for Orbital Debris and Program Manager of NASA's Orbital Debris Program Office (ODPO) and Mr. Tim Payne, Chief, Operational Assessments Division, HQ Air Force Space Command (AFSPC) A2/3/6Z.

During the meeting, NASA and DOD each made six presentations. In the first NASA

presentation, Dr. J.-C. Liou discussed the status and recent activities from the Inter-Agency Space Debris Coordination Committee (IADC) and debris-related issues from the United Nations/Committee on the Peaceful Uses of Outer Space. The latter discussion included progress by the Long Term Sustainability of Outer Space Working Group.

Dr. Sue Lederer presented the status of the ODPO Optical Measurements Group, including the current status of the Eugene Stansbery Meter-Class Autonomous Telescope (ES-MCAT) located at the John Africano NASA-AFRL Orbital Debris Observatory (JANAODO) on Ascension Island; observations conducted by the UK Infrared Telescope (UKIRT) and telescopes MODEST and Magellan; and ODPO Optical Measurement Center milestones. The ES-MCAT is a collaboration between NASA and the Air

Force Research Laboratory (AFRL) and its new designation as the ES-MCAT recognizes retired ODPO Program Manager Mr. Stansbery's ongoing inspiration for and guidance of the MCAT through its development and deployment. The ES-MCAT has made significant strides towards Initial Operational Capability since the previous meeting and this was reported on in detail.

Mr. Joe Hamilton provided a summary of the Space Debris Sensor (SDS), which is an embodiment of the Debris Resistive/Acoustic Grid Orbital NASA-Navy Sensor (DRAGONS) sensor concept developed by ODPO. The SDS is to be launched to the International Space Station (ISS) aboard the Space-X 13 COTS mission and will be mounted on the External Payload Facility's Starboard Overhead-X location on the European Space Agency's Columbus module. This sensor

continued on page 9

NASA-DOD Working Group

continued from page 8

will measure size, mass, and orbital parameters of small debris over its planned 3-year mission.

Dr. Mark Matney then presented a status on the development of the NASA ODPO Orbital Debris Engineering Model (ORDEM) v. 3.1. The ORDEM 3.1 version updates the radar and optical data sets used in its predecessor, ORDEM 3.0, to better characterize the modern orbital debris environment.

Dr. Jack Bacon presented an update to NASA Procedural Requirement (NPR) 8715.6 Rev. B and ODPO's plan for updating NASA Standard (NS) 8719.14B. The latter is scheduled to be complete in late 2017. Also discussed was the pending update of ODPO's Debris Assessment Software (DAS) from version 2.2 to 3.0, which will incorporate general improvements.

Dr. Heather Cowardin then presented status and plans for continued analysis of the DebrisSat fragments and the incorporation of these data into ODPO computer models of the collisional breakup of a modern satellite in planning for ORDEM 4.0. DebrisSat was a simulated satellite constructed with modern satellite materials that was fragmented by hypervelocity impact in 2014. Fragments from the test are still being extracted from the soft-catch material that lined the vacuum chamber during the test. At the time of the presentation, more than 143,000 fragments had been recovered with 11,492 characterized by the University of Florida, a DebrisSat consortium partner.

Following the morning NASA presentations, Dr. Josef Koller, Office of the Secretary of Defense, began the afternoon presentations with a review of the U.S. Government Interagency Policy Council (IPC) Space Safety Engagement Work Plan. The U.S. Government recognizes that additional attention is required in the areas of orbital debris mitigation, rendezvous and proximity operations, and large constellation and small spacecraft safety practices.

Mr. Jesse Edwards, Space & Missile Center (SMC)/ENC, provided a preview of the Space Debris 101 course. This course provides SMC space professionals with instruction in the fundamentals of orbital debris, policy, mitigation, risk assessment, and reporting.

Dr. Alan Jenkin, the Aerospace Corporation, presented findings on end-of-mission disposal options for critically-inclined (63.4°) low Earth and so-called Tundra orbits. The latter orbits are critically inclined, moderate eccentricity, 24-hour period orbits that can provide similar ground coverage to classic GEO operational orbits. Certain properties of these orbits impart the benefit of using natural perturbations to minimize orbital lifetime due to eccentricity growth. A concomitant benefit is lowering the collision probability during the disposal period.

Mr. Zach Slatton, AFSPC/18 SPCS, presented a briefing on the 18th Space Control Squadron's use of radar cross section (RCS) for collision avoidance reporting, tasking and

prioritization, and cataloging in the publicly-available Satellite Catalog. In particular, new methods of reporting a single, characteristic RCS in the catalog were reviewed.

Mr. Doug Moffitt, HQ AFSPC/A2/3/6SZ, followed up with a presentation dedicated to current status and plans for the Space Surveillance Telescope (SST). Developed by the Defense Advanced Research Projects Agency (DARPA) and transferred to AFSPC in 2016, the SST program demonstrated the fusion of advanced technologies for ground-based detection and follow-up tracking of small objects in deep space. The 3.5-meter telescope is optimized for synoptic space surveillance using short-duration/high-frequency search paradigms. Among the advanced technologies are a curved CCD focal plane camera and large telescope control technologies yielding the most dynamically agile telescope of its size. Last light at the White Sands Missile Range was in March 2017 and the SST is being disassembled for shipment and reinstallation in Western Australia. Australian first light is anticipated in late 2018 with an initial operational capability in 2020.

Mr. Tim Payne, AFSPC/A2/3/6Z, completed the workshop's presentations with a current status and plans for the Space Fence. The first element of the Space Fence is currently under construction on Kwajalein Atoll in the Pacific Ocean. The Space Fence is designed to discover and track objects as small as 2 cm at International Space Station altitudes. ♦

The 18th Advanced Maui Optical and Space Surveillance Technologies Conference (AMOS), 19-22 September 2017, Maui, Hawaii

The 18th Advanced Maui Optical and Space Surveillance Technologies Conference was held 19-22 September. This year's conference was reported to have the largest turnout of attendees with 739 registrations, 15 countries, and 26 exhibits. The opening keynote speaker was Douglas L. Loverro, former Deputy Assistant Secretary of Defense for U.S. Space Policy, U.S. Department of Defense. Mr. Loverro outlined his opinions on how the U.S. can better lead the world's space policy by encouraging all nations to recognize a shared responsibility to prevent mishaps, misperceptions, and mistrust. These were referred to as his "Principle Principles" during the talk and were also outlined in an open memorandum to the incoming Executive Secretary of the National Space Council published in *The Space Review* [1]. Following Mr. Loverro's

talk, a Space Situational Awareness (SSA) Policy Forum was held discussing the evolution of the commercial SSA industry. The forum was made up of Stewart Bain (CEO, Northstar), Doug Hendrix (CEO, ExoAnalytic Solutions), Tom Kubancik (vice president of Applied Defense Solutions), Edward Lu (Vice President Strategic Projects, LeoLabs), Helen Reed (Chief Technology Officer, Chandah Space Technologies), and Paul Welsh (Vice President, Analytical Graphics Inc.). The discussions focused on the various companies and organizations that are now providing services that compete with or augment SSA data products, previously only produced by the U.S. government, as a part of their business model.

The Orbital Debris session was co-chaired by Dr. Carolin Frueh (Purdue University) and Dr. Tim Flohrer (ESA/ESOC Space Debris

Office) and six technical papers were presented. The majority of talks involved studies to better understand debris associated with the Titan IIIC Transtage fragmentations. Two of these papers were presented by individuals from the Orbital Debris Program Office (ODPO): Dr. Heather Cowardin presented her paper entitled "*Characterizing GEO Titan IIIC Transtage Fragmentations Using Ground-Based and Telescopic Measurements*" and Dr. James Frith presented work on "*Characterizing the Survey Strategy and Initial Determination Abilities of the NASA MCAT Telescope for Geosynchronous Orbital Debris Environmental Studies*." Dr. Patrick Seitzer (University of Michigan) also presented his work on searches for dim debris objects using the 6.5-meter Magellan telescopes that also was supported by members of the ODPO

continued on page 10

AMOS Conference*continued from page 9*

team. Dr. Gouri Radhakrishnan (The Aerospace Corporation) presented her work on using laser ablation as an alternative method to high-velocity impact testing to simulate how different materials would react to debris impacts on orbit. This work was done in support of the DebrisSat project. Vatali Braun (ESA) presented ESA's recent work on improving their orbital debris environment models. Finally, a paper was presented on the application of the Magdalena Ridge Observatory's 2.4-meter telescope to tracking Titan IIIC Transtage debris presented by Dr. William Ryan. Following the day of talks, a poster session was held where Dr. Susan Lederer presented the paper "NASA's Optical Program on Ascension Island: Bringing MCAT to life as the Eugene Stansbery-Meter Class Autonomous Telescope (ES-MCAT)."

Day two of the conference began with a keynote address by Colonel Shinichiro Tsui (National Space Policy Secretariat, Cabinet Office, Government of Japan) who provided an overview of Japan's space policy. He noted the implementation of the SSA Information Sharing Act that took place in May 2013 and how that has helped the U.S. and Japan coordinate their

SSA efforts. Following Colonel Tsui's talk, a Space Policy Forum was held with the topic being "Challenges and Opportunities from Large Commercial Constellations." Tim Flohrer (ESA/ESOC), Cyrus Foster (Planet), Gary Henry (Director of Space Defense and Intelligence, Boeing), and Diana McKissock (18th Space Control Squadron) all participated. Improvements to the Space Surveillance Network were discussed as well as many topics about how to protect the space environment via policy and mitigation techniques.

Dr. Heather Cowardin (Project Manager, Jacobs-JETS Orbital Debris Research and Science Operations) co-chaired the Non-Resolved Object Characterization session, which focused on topics such as applying polarimetry to space object identification, shape studies, and light curve analysis. Additionally, Dr. Ryan Hoffman (Air Force Research Laboratory [AFRL]) presented work that was done in collaboration with Dr. Cowardin on how space aging can change the reflective properties of materials.

Day three featured an invited talk by both Colonel Russ Teehan (director, Space Vehicles Directorate, AFRL) and Colonel John Anttonen

(Director, Advanced Systems and Development Directorate, Air Force Space and Missile Center). This joint talk discussed a collaboration between the two Air Force directorates to develop and deploy technology and methods much quicker than has been done using traditional methods. They have begun an investigation into employing venture capitalist techniques from Silicon Valley organizations towards rapid improvements of Air Force capabilities. More information about the conference is available online at <https://amostech.com/18th-annual-amos-conference-focuses-on-space-security/>.

Following the AMOS conference, the Non-Imaging Space Object Identification Workshop, hosted by Paul Kervin (AFRL), was held over a 2-day span. There a presentation by Dr. James Frith entitled "Adapting Surveys of the GEO Orbital Debris Environment to Statistically Sample Eccentric Orbits" was given.

Reference

Loverro, D. "Why the US must lead again," The Space Review, <http://www.thespacereview.com/article/3307/1>, August 14, 2017, accessed October 3, 2017. ♦

The 68th International Astronautical Congress (IAC), 25-29 September 2017, Adelaide, Australia

The 68th International Astronautical Congress (IAC) took place on 25-29 September in Adelaide, Australia, with about 4,500 participants from the global aerospace community. Like the previous IACs, the Space Debris Symposium held during the IAC was organized by the Space Debris Committee of the International Academy of Astronautics (IAA). This year's Space Debris Symposium consisted of 11 sessions. They included debris measurements, modeling, hypervelocity impacts, mitigation, debris removal concepts, debris removal technologies, orbit determination, space situational awareness, one joint session with the Space Security Committee on the policy and

legal aspect of debris mitigation and removal, one joint session with the Small Satellite Symposium to focus on debris issues associated with small satellites, and one interactive presentation session. A total of 82 papers were presented during the first 10 sessions and 31 papers were presented at the interactive session. The debris removal concepts session had the best overall attendance record with a total of 120, followed by the debris modeling session with a total of 95. Highlights from the debris removal concepts session included updates on the "RemoveDebris" active debris removal (ADR) technology demonstration mission, which is scheduled for launch to the International Space

Station in early 2018, prototyping of the capture system for a proposed "CleanSpace One" mission, and the progress of ESA's "eDeorbit" mission study, which aims to remove ESA's 8-ton defunct Envisat around 2024.

In addition to the technical programs, many plenary sessions, panel discussions, and Global Networking Forum events were arranged during the 68th IAC. As the hosting country, Australia took this opportunity to announce its plan to establish a national space agency and play a more active role in global space activities. On the last day of the IAC, Dubai was selected to host the 71st IAC in 2020. ♦

SUBSCRIBE to the ODQN or UPDATE YOUR SUBSCRIPTION ADDRESS

If you would like to be notified when a new issue of the ODQN is published or have already subscribed but no longer receive email notifications, please update your email address using the ODQN Subscription Request Form located on the NASA Orbital Debris Program Office

(ODPO) website at www.orbitaldebris.jsc.nasa.gov. You can access this form by clicking first on the "Quarterly News" tile, then selecting the navigation link within the sentence "to be notified by e-mail...".

UPCOMING MEETINGS

25-27 June 2018: 5th International Workshop on Space Debris Modeling and Remediation, Paris, France

CNES will follow the tradition established in 2010 to organize and host the 5th workshop at its HQ in Paris in 2018. The workshop will include both oral presentation and poster sessions. The modeling topics to be covered include general environment modeling and

modeling of potential negative effects from small satellites and large constellations to the environment. The remediation topics to be covered include roadmap studies, high-level system studies, large and small debris removal concept studies, technology development,

GNC and proximity operations, and the policy, economics, and international cooperation aspects of remediation. Please contact the chair of the workshop organizing committee Mr. Christophe Bonnal, Christophe.Bonnal@cnes.fr, for further information.

14-22 July 2018: COSPAR 2018, Pasadena, CA, USA

The 42nd Assembly of the Committee on Space Research (COSPAR) Scientific will convene in the Pasadena Convention Center on Saturday, 14 July 2018 and run through Sunday, 22 July. This assembly marks the 60th year of COSPAR. The COSPAR panel Potentially Environmentally Detrimental

Activities in Space (PEDAS) will conduct a program entitled "Space Debris – Providing the Scientific Foundation for Action." PEDAS.1 sessions will include advances in ground- and space-based measurements of the orbital debris environment, micrometeoroid and orbital debris environment modeling,

risk assessment, mitigation and remediation, hypervelocity impact range developments, and protection. The abstract submission deadline is 9 February 2018. Please see the COSPAR website at <https://cosparhq.cnes.fr/content/cospar-2018> and the Assembly website <http://cospar2018.org/> for further information.

ODQN Vol. 21 Updates and Errata

Readers should note these updates to launches appearing in the tables of International Space Missions for ODQN volume 21, issues 1 and 2. The identities of objects associated with these two launches, including tabulation of cataloged debris, were not available as those issues were released.

In addition Objects B-E, inclusive, of launch 2017-019 have been identified as Lemur

2 3U CubeSats, but their unique identities, so far, have not been correlated with the Space Surveillance Network catalog as of 5 October 2017. The primary payload of this launch was the Cygnus OA-7 cargo vessel *S.S. John Glenn*; following departure from the International Space Station the vehicle maneuvered to a higher altitude orbit and deployed the CubeSats.

We have noted that in issue 21-3 the Satellite Box Score's informational date was stated to be 4 April 2017; this date had not been updated from issue 21-2. The correct date is 04 July 2017. ♦

International Designator	Payloads	Country/ Organization	Perigee Altitude (KM)	Apogee Altitude (KM)	Inclination (DEG)	Earth Orbital Rocket Bodies	Other Cataloged Debris
2016-066A	XPNV-1	CHINA	491	515	97.4	1	2
2016-066B	XIAOXIANG 1	CHINA	490	512	97.4		
2016-066C	PINA 2A	CHINA	489	513	97.4		
2016-066D	PINA 2B	CHINA	489	513	97.4		
2016-066E	LISHUI 1-01	CHINA	504	1028	98.8		
2017-002A	XY S 1	CHINA	529	546	97.5	1	0
2017-002B	JILIN-1-03	CHINA	531	547	97.5		
2017-002C	KAIDUN 1	CHINA	528	542	97.5		

SATELLITE BOX SCORE

(as of 04 October 2017, cataloged by the
U.S. SPACE SURVEILLANCE NETWORK)

Country/ Organization	Payloads*	Rocket Bodies & Debris	Total
CHINA	254	3583	3837
CIS	1519	4994	6513
ESA	76	57	133
FRANCE	64	481	545
INDIA	85	118	203
JAPAN	166	97	263
USA	1594	4689	6283
OTHER	856	114	970
TOTAL	4614	14133	18747

* active and defunct

Visit the NASA

Orbital Debris Program Office Website

www.orbitaldebris.jsc.nasa.gov

Technical Editor

Phillip Anz-Meador, Ph.D.

Managing Editor

Debi Shoots



Correspondence concerning
the ODQN can be sent to:

NASA Johnson Space Center
The Orbital Debris Program Office
Attn: JE104/Debi Shoots
Houston, TX 77058



debra.d.shoots@nasa.gov



National Aeronautics and Space Administration
Lyndon B. Johnson Space Center
2101 NASA Parkway
Houston, TX 77058

www.nasa.gov
<http://orbitaldebris.jsc.nasa.gov/>

INTERNATIONAL SPACE MISSIONS

01 July 2017 – 30 September 2017

International Designator	Payloads	Country/ Organization	Perigee Altitude (KM)	Apogee Altitude (KM)	Inclination (DEG)	Earth Orbital Rocket Bodies	Other Cataloged Debris
2017-041A	INTELSAT 35E	INTELSAT	35778	35796	0.0	1	0
1998-067MU	BIRD JJ	JAPAN	393	395	51.64	0	0
1998-067MV	BIRD GG	GHANA	394	396	51.64		
1998-067MW	BIRD MM	MONGOLIA	394	396	51.64		
1998-067MX	BIRD BB	BANGLADESH	391	398	51.64		
1998-067MY	BIRD NN	NIGERIA	392	398	51.64		
2017-042A	KANOPUIS-V-1K	RUSSIA	506	509	97.4	0	0
2017-042B-CA	(72 ADDITIONAL SMALL PAYLOADS)	VARIOUS					
2017-043A	SOYUZ MS-05	RUSSIA	402	408	51.64	1	0
2017-021F	SILKROAD 1	CHINA	379	390	42.78	0	0
2017-044A	OPTSAT 3000	ITALY	440	461	97.22	0	2
2017-044B	VENUS	ISRAEL	721	725	98.34		
2017-045A	DRAGON CRS-12	USA	393	398	51.64	0	2
2017-046A	COSMOS 2520	RUSSIA	35774	35796	0.0	1	1
1998-067MZ	TOMSK-TPU 120	RUSSIA	393	402	51.64	0	0
1998-067NA	TANYUSHA 1	RUSSIA	393	402	51.64		
1998-067NB	TANYUSHA 2	RUSSIA	394	402	51.64		
1998-067NC	SFERA 2	RUSSIA	392	399	51.64		
1998-067ND	TNS 0-2	RUSSIA	395	402	51.64		
2017-047A	TDRS 13	USA	35763	35810	6.97	1	0
2017-048A	QZS-3	JAPAN	35777	35795	0.07	1	0
2017-037D	COSMOS 2521	RUSSIA	651	666	97.91	0	0
2017-049A	FORMOSAT-5	TAIWAN	715	732	98.29	0	0
2017-050A	ORS 5 SENSORSAT	USA	NO ELEMENTS AVAILABLE			2	4
2017-051A	IRNSS 1H/PSLV*	INDIA	157	6268	19.17	1	2
2017-052A	OTV 5 (USA 277)	USA	NO ELEMENTS AVAILABLE			1	0
2017-053A	AMAZONAS 5	SPAIN	35784	35789	0.06	1	1
2017-054A	SOYUZ MS-06	RUSSIA	402	408	51.64	1	0
2017-055A	COSMOS 2522 (GLONASS)	RUSSIA	19154	19208	64.81	1	0
2017-056A	USA 278	USA	NO ELEMENTS AVAILABLE			0	0
2017-057A	ASIASAT 9	ASIASAT	35783	35792	0.02	1	1
2017-058A	YAOGAN-30A	CHINA	592	600	35	1	0
2017-058B	YAOGAN-30B	CHINA	593	601	35		
2017-058C	YAOGAN-30C	CHINA	594	601	35		
2017-059A	INTELSAT 37E	INTELSAT	35775	35795	0.02	1	1
2017-059B	BSAT-4A	JAPAN	35775	35798	0.02		

* Payload and upper stage left in useless orbit due to malfunction.