

## **Guidance on Including Multiple Designs in an International Application in Order to Forestall Possible Refusals**

**(Article 13(1) of the Geneva Act (1999) and Section 407 of the Administrative Instructions for the Application of the Hague Agreement)**

### **GENERAL DISCLAIMER:**

*This Guidance is prepared in consultation with the Offices of the Contracting Parties that notified the International Bureau of the World Intellectual Property Organization (WIPO) under Article 13(1) of the Geneva Act that its applicable law contains special requirements concerning unity of design, and with the Offices of Contracting Parties, which have a “related design system”<sup>1</sup>. This Guidance, which is neither self-sufficient nor exhaustive, aims to help applicants to avoid a possible refusal by these Offices, when including multiple designs in the same application. The table at the end summarizes the relevant recommendations made by these Offices concerned.*

---

<sup>1</sup> As of the issuance date of this Guidance, there are 10 Contracting Parties, which have made a declaration concerning unity of design and two Contracting Parties, which have a “related design system”.

## ABOUT THIS GUIDANCE

### Multiple Design Application (Rule 7 of the Regulations)

An applicant may include multiple designs in a single international application (up to a maximum of 100) provided they belong to the same class of the Locarno Classification (Rule 7(3)(v) and (7) of the Regulations).

However, Offices of certain Contracting Parties may refuse the effects of an international registration *containing multiple designs* due to their domestic law requirements relating to unity of designs or related designs.

### Unity of Design (Article 13(1) of the Geneva Act)

A Contracting Party whose law, at the time of becoming a party to the Geneva Act, requires that designs that are the subject of the same application conform to a requirement of unity of design, unity of production or unity of use, or belong to the same set or composition of items, or that only one independent and distinct design may be claimed in a single application, may notify a declaration to that effect, in accordance with Article 13(1). The requirements which may vary from one Contracting Party to another must be specified in the declaration. Contracting Parties which have made this declaration are listed in the table at the end of this document.

This declaration enables the Contracting Party to issue a refusal, if the requirements are not met. Accordingly, some Contracting Parties, which have made this declaration issue refusals and require the deletion of some designs from the international registration. Any such refusal may be overcome normally through a procedure before the Office concerned, *i.e.*, by dividing the international registration.

Applicants who wish to designate a Contracting Party which has made this declaration are advised to consult the [Hague Guide for Users](#): “[How to Complete the International Application \(DM/1 Form or eHague\)?](#)”, “[Item 6: Number of Industrial Designs, Reproductions and/or Specimens \(mandatory\)](#)”, “[Refusal of Protection](#)”, and “[Unity of Design](#)”.

### Related Designs (Section 407 of the Administrative Instructions)

Japan and the Republic of Korea did not make a declaration under Article 13(1) of the Geneva Act concerning a unity of design requirement, but when filing a multiple design application that designates either of them, it is necessary to bear in mind that their “related design system” may apply.

Under these Contracting Parties’ “related design system”, a design (design B) similar to another design (design A) that is the subject of the same national or international application or of a prior national or international application or registration and that belongs to the same person may only be registered as a “related design” (design B) by specifying its “principal design” (design A). In other words, if those two designs are considered similar, design B can only be accepted as a design related to design A<sup>2</sup>. There may be several related designs per principal design, while there must be only one principal design per related design.

Where the related design concept applies, failure to indicate the principal design and its related designs in an international application may lead to a refusal from the Office of these two Contracting Parties. Conversely, indicating a principal design and related designs in an international application when they are not considered to be similar may also lead to a refusal. Any such refusal may be overcome through a procedure before the relevant Office, by providing the missing indication or amending the erroneous indication.

---

<sup>2</sup> In order to avoid unnecessary complication however, this Guidance does not address the similarity that may be considered between a design contained in a prior application or registration and that contained in a given international application.

Detailed explanations on the concept of such a “related design system” and how to indicate a principal design and related designs in an international application are provided in the [Hague Guide for Users](#): “How to Complete the International Application (DM/1 Form or eHague)?”, “Item 16: Relation With a Principal Design (optional element applicable only to the designation of Japan and/or the Republic of Korea)”.

### Purpose of the Guidance

This Guidance illustrates different combinations of multiple designs that may be included in an international application and their significance when designating relevant Contracting Parties. The aim is to mitigate the risk of refusals from the Offices.

It is not within the competence of the International Bureau to express an opinion on the respective requirements, including the usage of terms contained in the applicable laws, regulations and/or declarations made. For explanatory purposes only, the Guidance addresses “similarity of designs” and uses the term “unity of design” as a general concept where multiple designs may be accepted, whether as a single design (with its variants) or as a group of similar designs, by a given Office. The determination of the similarity and other requirements relating to unity of design, are matters within the competence of each designated Contracting Party. The International Bureau does not check any of those requirements.

### **TABLE OF CONTENTS**

- (1) Different designs for different products
- (2) Different designs for the same product indication
- (3) Designs to different claimed parts of identical products
- (4) Difference in color
- (5) Difference in non-essential surface ornamentation
- (6) Difference in proportion
- (7) Difference in quantity of repeating elements
- (8) Difference in minor details
- (9) Designs identical in shape but in different graphic representations
- (10) A design for a set of articles presented in multiple designs
- (11) A design for a set of articles presented in multiple views of a single design

## COMBINATIONS OF MULTIPLE DESIGNS AND GUIDANCE

### (1) Different designs for different products

The international application contains the following two designs, which belong to the same class of the Locarno Classification (Paper clips: LOC19-02, Crayons LOC19-06). The products and overall shapes of the designs significantly differ.

Example:

*(Design 1) Indication of the product: "Paper clip"*

*(Design 2) Indication of the product: "Crayon"*

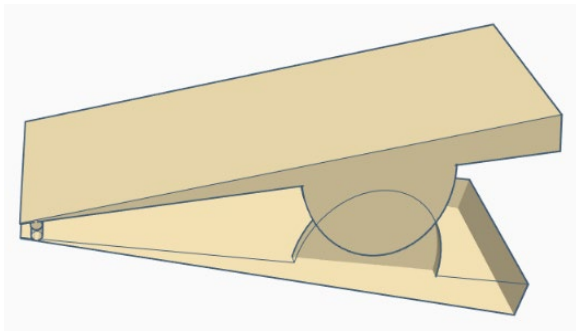

1.1



2.1

### (2) Different designs for the same product indication

The international application contains the following two designs for the same product indication. However, the overall shape of the designs significantly differ.

Example:

*(Design 1) Indication of the product: "Flower Vase"*

*(Design 2) Indication of the product: "Flower Vase"*

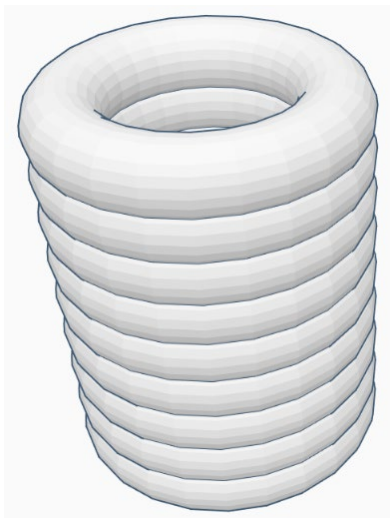

1.1

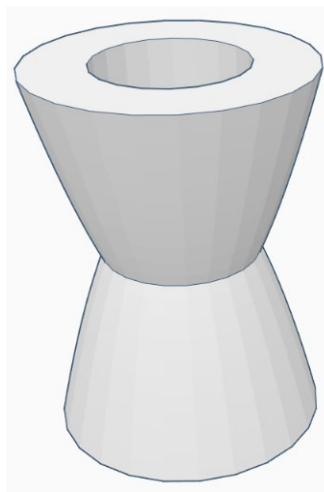

2.1

## (3) Designs to different claimed parts of identical products

The international application contains the following two designs for the identical product. The products shown look identical but Design No. 1 claims the whole product (the liquid vessel and handle) while Design No. 2 only claims a specific part (the handle) of the product and the other parts are disclaimed.

Example:

(Design 1) Indication of the product: "Cup"

(Design 2) Indication of the product: "Cup"

*Description: The part shown by means of broken lines in the reproduction is not part of the claimed design.*

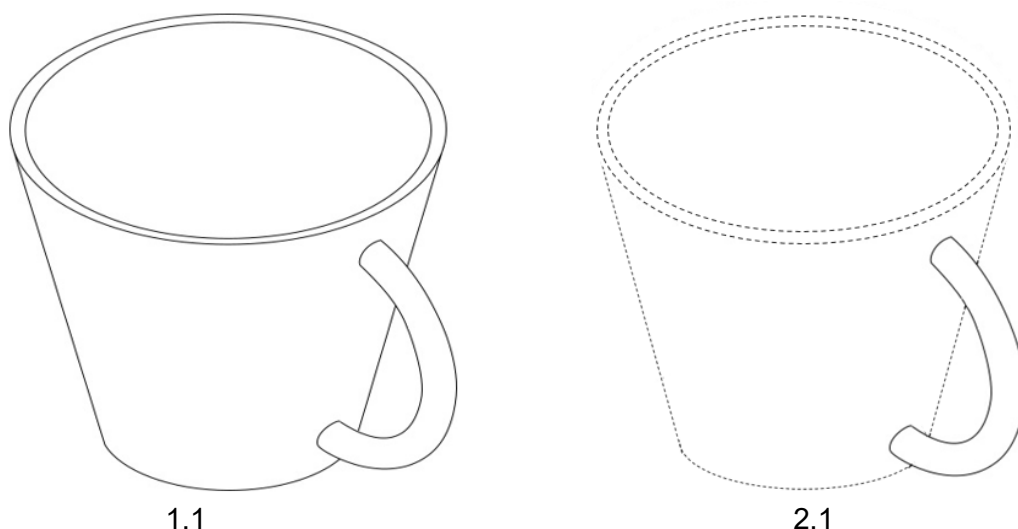

## GUIDANCE

Unity of Design

The designs may not be considered to meet the requirement of unity of design in the above three cases ((1) to (3)). The Office concerned may issue a refusal pending compliance with the requirement of unity of design and request the deletion of one of the two designs. However, the requirement of unity of design may be met, depending on the scope of the claimed parts of the two designs in the case of (3)<sup>3</sup>.

Related Designs

The designs may not be considered similar to each other. It would not be appropriate to provide an indication of a principal design and a related design in these cases. However, there may be cases where designs are considered to be similar, depending on the scope of the claimed parts of the two designs, in the case of (3).

<sup>3</sup> Comment by the United States Patent and Trademark Office (USPTO): For the purposes of the designation of the United States of America, embodiments directed to a design as a whole as well as individual parts or portions thereof may not be included in a single application if the appearances are patentably distinct. However, a design claim may cover embodiments of different scope directed to the same inventive concept within a single application if the designs are not patentably distinct. In determining whether embodiments of different scope can be retained in a single application they must have overall appearances that are basically the same, and the difference in scope must be insufficient to patentably distinguish one design from the other. Differences may be considered insufficient to patentably distinguish when they are de minimis or obvious to a designer of ordinary skill in the art.

(4) Difference in color

The international application contains the following three designs for the same product. Their overall shapes are the same even if the colors of the lid are different (Designs 1, 2 and 3 have lids colored red, yellow and blue, respectively).

Example:

(Designs 1 to 3) Indication of the product: "Bottles for cosmetics"

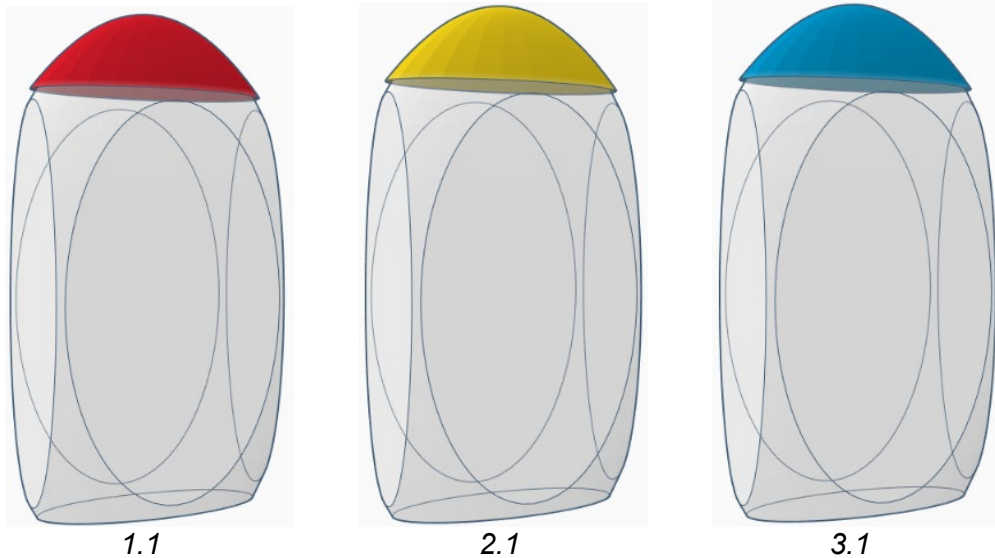

(5) Difference in non-essential surface ornamentation

The international application contains the following three designs for the same product. Their overall shapes are identical but there are differences in a non-essential part of the surface ornamentation (Designs 1, 2 and 3 bear the shapes of a hexagon, heart and star, respectively).

Example:

(Designs 1 to 3) Indication of the product: "Bottles for cosmetics"

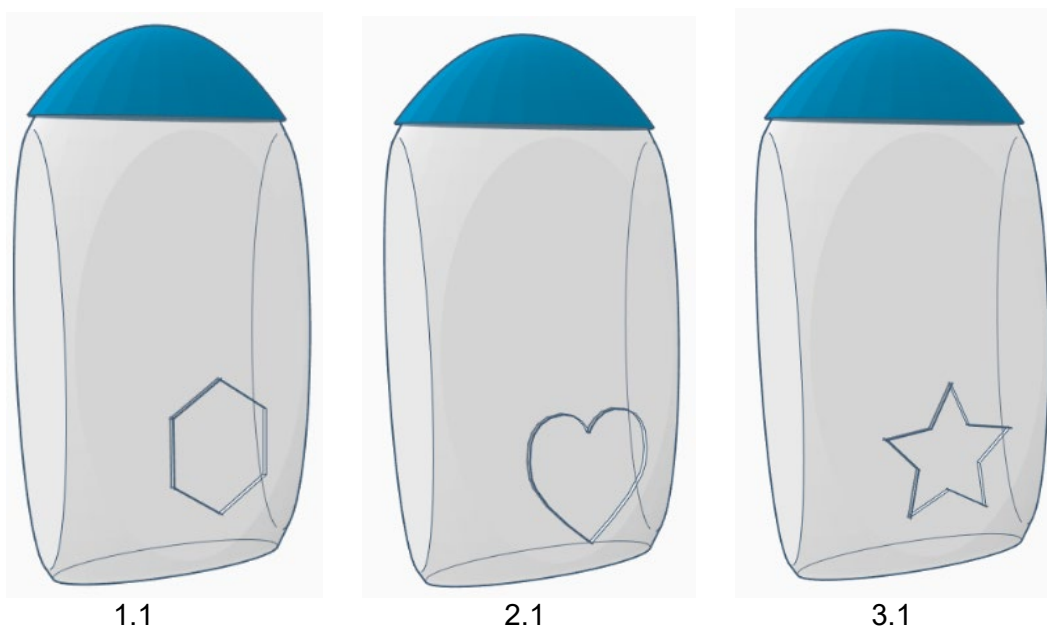

## (6) Difference in proportion

The international application contains the following three designs for the same product. Their essential features are the same but there are differences in the vertical or horizontal proportion (Design 1: standard proportion, Design 2: narrower than Design 1, Design 3: shorter than Design 1).

Example:

(Designs 1 to 3) Indication of the product: "Bottles for cosmetics"

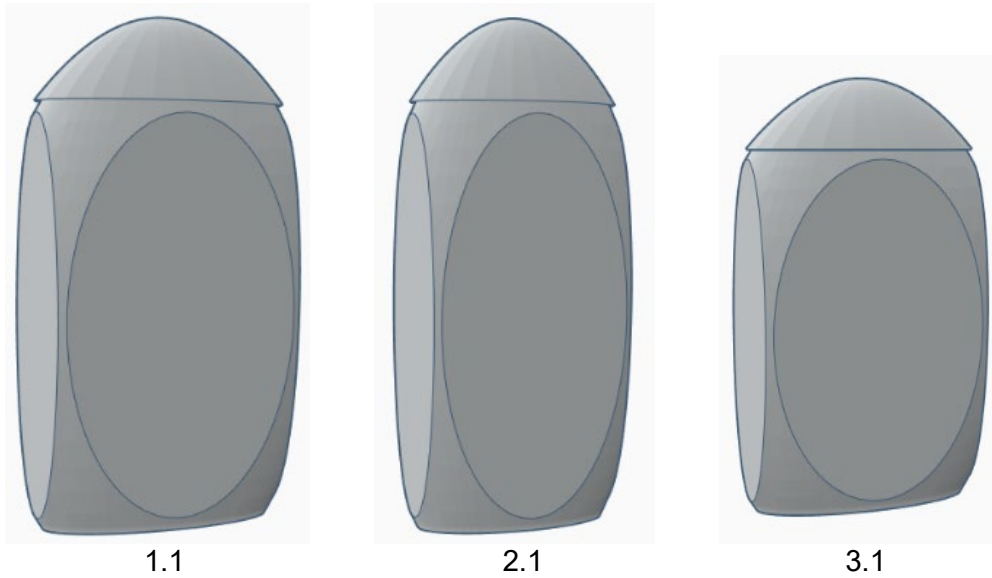

## (7) Difference in quantity of repeating elements

The international application contains the following two designs for the same product. Their overall impression is the same but there is a difference in the number of spokes (Designs 1 and 2, have 18 and 24 spokes, respectively).

Example:

(Designs 1 and 2) Indication of the product: "Wheels for vehicles"

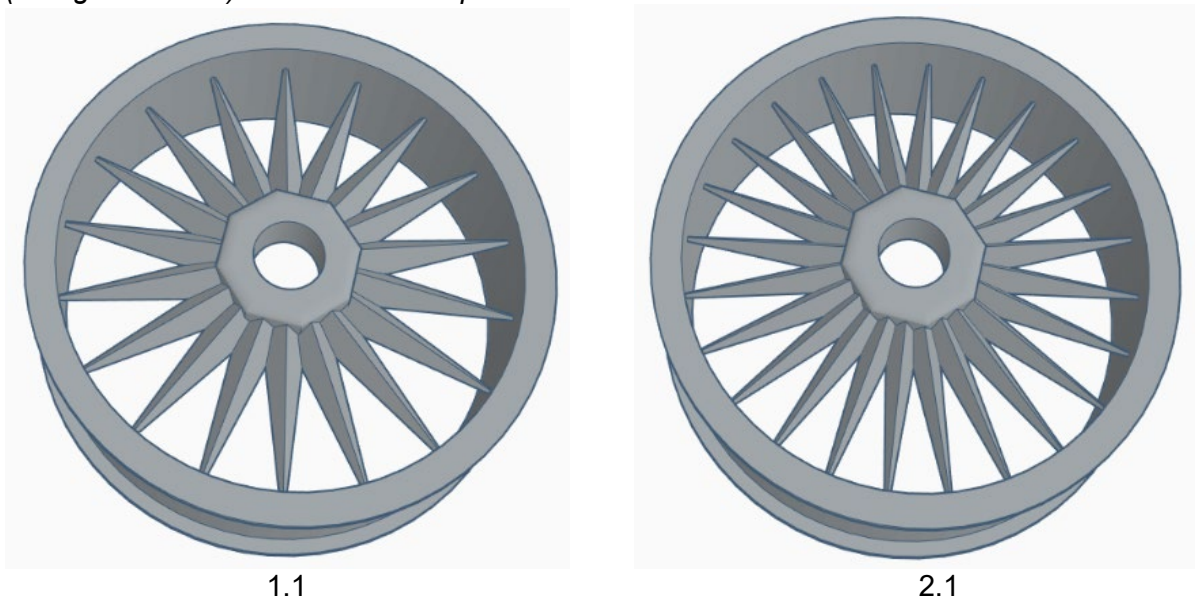

## (8) Difference in minor details

The international application contains the following two designs for the same product. Their overall impression appears the same but there is a difference in an insignificant part (Design 2 has a ring on the mounting part).

Example:

(Designs 1 and 2) Indication of the product: "Side-view mirrors for vehicles"

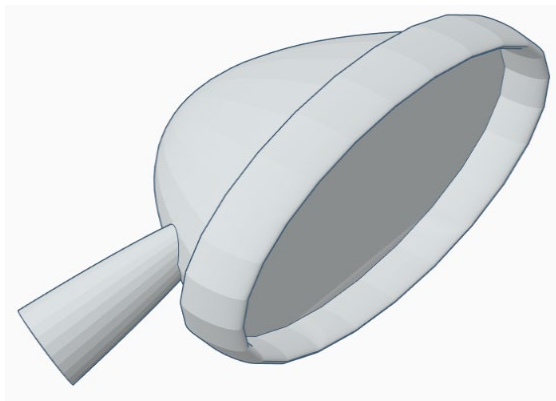

1.1

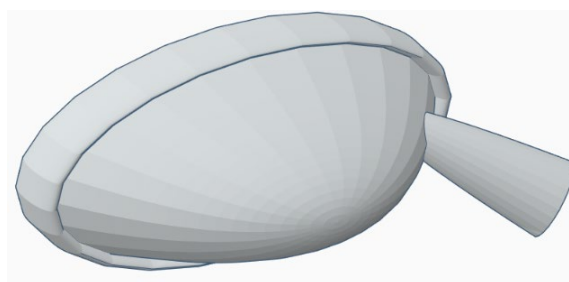

1.2

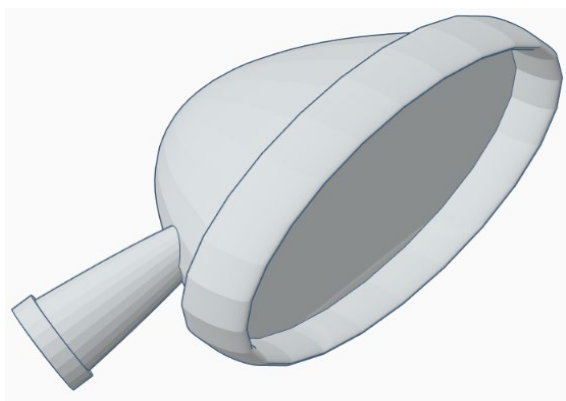

2.1

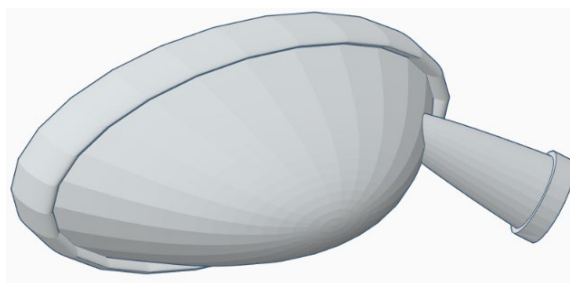

2.2

## GUIDANCE

The cases (4) to (8) show different combinations of multiple designs. Cases like this may be considered as variants of the same design or a group of similar designs by the Offices concerned.

Unity of Design

If the designs are considered as variants of the same design or a group of similar designs, meeting the applicable requirement of unity of design, they should be accepted by the Office concerned.



### Related Designs

The applicant may wish to consider selecting one of the designs as the principal design for the other design(s) (for example, principal design: Design 1 and related design: Design 2). Where there are more than two similar designs, the applicant should select for the principle design one that is considered to be similar to all of those designs. Taking Example (6), Designs 1 and 2, and Designs 1 and 3 may be considered similar because they only differ in width or height, respectively, but Designs 2 and 3 are less likely to be so considered as they differ in both width and height. Therefore, the applicant should consider selecting Design 1, as the principal design and Designs 2 and 3 as its related designs, rather than selecting Designs 2 or 3, as the principal design for the others.

#### (9) Designs identical in shape but in different graphic representations

The international application contains the following two designs. Both designs look identical in shape, but are represented in different graphic representations (Design 1: line drawing and Design 2: computer graphic with color)

Example:

*(Design 1) Indication of the product: "Cup"*

*(Design 2) Indication of the product: "Cup"*

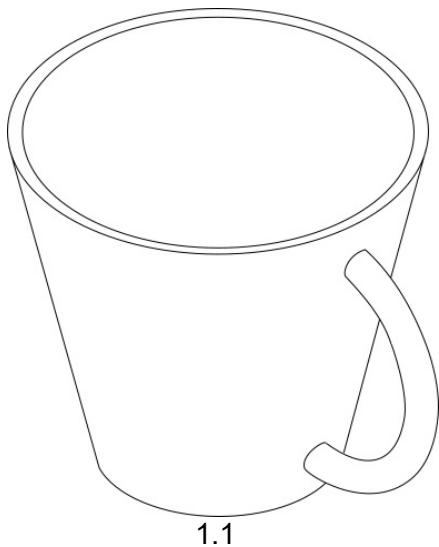

#### GUIDANCE

Even if these two designs are identical in shape, they may be considered as different designs but which may still be considered similar.

#### Unity of Design

If the two designs are considered as variants of the same design or a group of similar designs meeting the applicable requirement of unity of design, they should be accepted by the Office concerned.



(11) A design for a set of articles presented in multiple views of a single design

The international application contains the following single design. Reproduction 1.1 shows a set of products while Reproductions 1.2 and 1.3 show each of its components.

Example:

(Design 1) Indication of the product: “Set of table and stools”

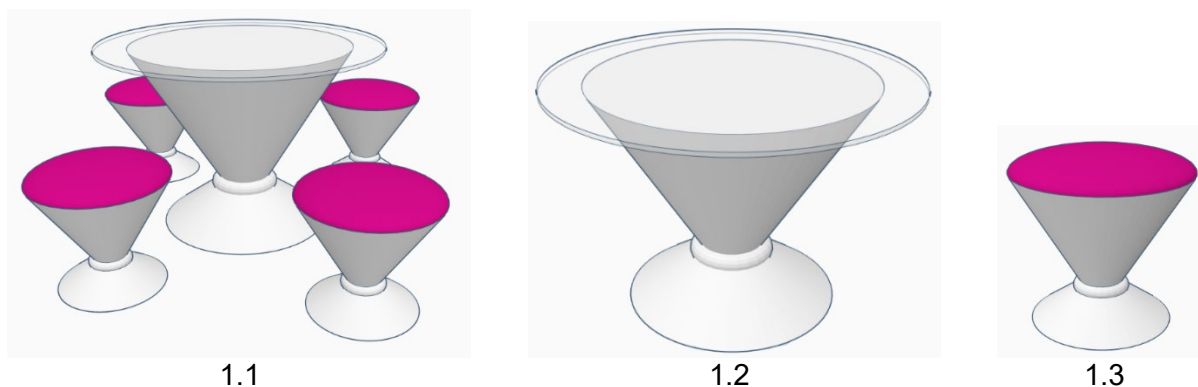

## GUIDANCE

The subject design and its reproductions are the same as the previous example. However, the design is presented as a single design by submitting multiple views (1.1, 1.2 and 1.3). The product name indicates that it is a set design.

### Unity of Design

As the design is presented as a single design, the question is no longer the acceptability of multiple designs as filed and registered with the International Bureau. The design may still be the subject of a refusal by the Office of any Contracting Party for substantive reasons, in particular the definition of a design<sup>5</sup>.

### Related Designs

As the design is presented as a single design, it is not possible to indicate a principle design. The related design concept does not apply and the relevant Office would not issue a refusal based on this requirement.

<sup>5</sup> For instance, the Republic of Korea has made a declaration under Rule 9(3) of the Regulations, to the effect that, if the design is for a set of articles, one view of the coordinated whole and corresponding views of each of its components are required.

LIST SHOWING EXAMPLES AND RECOMMENDATIONS  
BY THE OFFICES OF RELEVANT CONTRACTING PARTIES

| EXAMPLES   | Unity of design and other requirements notified in the declarations under Article 13(1) |     |    |    |     |    |     |    |    |     |     |     | Related designs |                 |
|--|---|-----|----|----|-----|----|-----|----|----|-----|-----|-----|-----------------|-----------------|
|  | BR*   | CN* | EE | KG | MX* | RO | RU* | SY | TJ | US* | UZ* | VN* | JP              | KR              |
| (1) Different designs for different products                                       | X   | X   | X  |    | X   | ○  | X   |    |    | X   | X   |     | --              | --              |
| (2) Different designs for the same product   | X   | X   | X  |    | X   | ⊙  | X   |    |    | X   | X   |     | --              | --              |
| (3) Identical designs with different claimed part                                  | X   | ○   | ○  |    | X   | ○  | X   |    |    | X   | X   |     | ◇               | --              |
| (4) Difference in color  | ⊙   | ○   | ⊙  |    | ⊙   | ⊙  | ⊙   |    |    | ○   | ⊙   |     | ◇               | ◇               |
| (5) Difference in non-essential surface ornamentation                              | ○   | ○   | ⊙  |    | ⊙   | ⊙  | ○   |    |    | ○   | ○   |     | ◇               | ◇               |
| (6) Difference in proportion   | ⊙   | ⊙   | ⊙  |    | ⊙   | ⊙  | ○   |    |    | ○   | ○   |     | ◇               | ◇               |
| (7) Difference in quantity of repeating elements                                   | ⊙   | ○   | ⊙  |    | ⊙   | ⊙  | ○   |    |    | ○   | ○   |     | ◇               | ◇               |
| (8) Difference in minor details  | ⊙   | ⊙   | ⊙  |    | ○   | ⊙  | ○   |    |    | ○   | ○   |     | ◇               | ◇               |
| (9) Designs identical in shape but in different graphic representations            | ⊙   | ○   | X  |    | ⊙   | ⊙  | ⊙   |    |    | ○   | ⊙   |     | ◇               | ◇               |
| (10) A design for a set of articles presented in multiple designs                  | X   | ○   | X  |    | X   | ⊙  | ⊙   |    |    | X   | ⊙   |     | -- <sup>6</sup> | -- <sup>6</sup> |
| (11) A design for a set of articles presented in multiple views of a single design | ○   | X   | ○  |    | ⊙   | X  | ⊙   |    |    | ○   | ⊙   |     | --              | --              |

Unity of design (acceptability of multiple designs in a single application)

⊙: May be accepted    ○: Depending on the case    X: Refusal expected

BR: Brazil\*; CN: China\*; EE: Estonia; KG: Kyrgyzstan; MX: Mexico\*; RO: Romania; RU: Russian Federation\*; SY: Syrian Arab Republic; TJ: Tajikistan; US: United States of America\*; UZ: Uzbekistan\*; VN: Viet Nam\*

<sup>6</sup> Refer to the specific case described in footnote 5.

\* If the Office of any of these Contracting Parties issues a refusal for non-compliance of the requirements notified in the declaration, any additional design incompatible with the applicable requirements must be eliminated from the international registration, through a procedure before the Office concerned.

Note for China: if the application contains two or more “similar designs” for the same product, the total number of the designs cannot exceed 10, and the applicant must indicate one of them as the “main design” which is similar to all the others.

Indication of a principal design (and related designs)

◇: May be required (depending on the case)    --: Not required

JP: Japan;    KR: Republic of Korea

*Note that the Offices' indications are of general nature and do not specifically relate to the examples shown in this Guidance.*