

NASA Reference Publication 1036

ALSEP Termination Report

James R. Bates

Lyndon B. Johnson Space Center, Houston, Texas

W. W. Lauderdale

General Electric Company, Houston, Texas

Harold Kernaghan

Kentron International, Inc., Houston, Texas



National Aeronautics
and Space Administration

**Scientific and Technical
Information Office**

1979

FOREWORD

This report summarizes the Apollo Lunar Surface Experiments Package (ALSEP) operations and provides background information for studies in lunar science. The report was prepared when the receipt of data from the lunar surface was terminated on September 30, 1977; it is intended as an overview of the ALSEP activities, and specific details relative to ALSEP scientific data are outside the scope of information presented here. The ALSEP data for scientific analysis requirements can be obtained from the National Space Science Data Center (NSSDC), Code 601.4, Goddard Space Flight Center, Greenbelt, Maryland 20771.

Details regarding the placing of ALSEP stations on the lunar surface have been covered thoroughly in many publications; such information will not be presented here. Documentation on the ALSEP design, development, and operations are archived at the Lyndon B. Johnson Space Center and at other NASA centers.

CONTENTS

Section	Page
1. INTRODUCTION	1-1
ALSEP LOCATIONS AND START TIMES	1-1
PROGRAM INFORMATION SUMMARY	1-4
ALSEP CONFIGURATIONS	1-5
2. ALSEP DESCRIPTION	2-1
SYSTEM CHARACTERISTICS	2-1
Central Station	2-1
Dust Detector	2-1
Radioisotope Thermoelectric Generator	2-3
EASEP Passive Seismic Experiment	2-3
Active Seismic Experiment	2-4
Lunar Seismic Profiling	2-4
Heat Flow Experiment	2-4
Solar Wind Experiment	2-6
Suprathermal Ion Detector	2-6
Cold Cathode Ion Gage	2-7
Magnetometer Experiment	2-7
Charged Particle Experiment	2-7
Passive Seismic Experiment	2-8
Lunar Ejecta and Meteorites Experiment	2-8
Lunar Mass Spectrometer	2-8
Lunar Surface Gravimeter	2-9

Section	Page
SUBSYSTEMS OF CENTRAL STATION	2-9
Structural/Thermal Subsystem	2-9
Data Subsystem	2-12
Electrical Power Subsystem	2-16
3. DATA MANAGEMENT AND ALSEP OPERATION	3-1
TRACKING STATIONS	3-1
ALSEP CONTROL TEAMS	3-1
FLIGHT CONTROLLER PERSONNEL	3-5
OPERATION ROOMS	3-5
OPERATIONS PLANNING MEETINGS	3-7
REFERENCE FILE	3-7
ALSEP DATA	3-7
Real-Time Data to JSC	3-7
Experiment Data	3-8
ARCHIVING	3-12
NSSDC ARCHIVED DATA	3-13
4. OPERATIONAL HISTORY	4-1
PASSIVE SEISMIC EXPERIMENT	4-2
ACTIVE SEISMIC EXPERIMENT	4-7
LUNAR SURFACE MAGNETOMETER	4-9
SOLAR-WIND SPECTROMETER	4-13
SUPRATHERMAL ION DETECTOR	4-15
HEAT FLOW EXPERIMENT	4-19
CHARGED PARTICLE LUNAR ENVIRONMENT EXPERIMENT	4-20
COLD CATHODE ION GAGE	4-22

Section	Page
LASER RANGING RETROREFLECTOR	4-24
LUNAR EJECTA AND METEORITES EXPERIMENT	4-25
LUNAR SEISMIC PROFILING EXPERIMENT	4-26
LUNAR ATMOSPHERIC COMPOSITION EXPERIMENT	4-27
LUNAR SURFACE GRAVIMETER	4-29
DUST DETECTOR EXPERIMENT	4-31
CENTRAL STATION ELECTRONICS	4-32
5. TERMINATION ANALYSIS (ENGINEERING CLOSEOUT TESTS)	5-1
STATUS OF EXPERIMENTS	5-1
TEST CONSTRAINTS	5-2
ENGINEERING TESTS	5-3
Apollo 12 ALSEP Tests	5-3
Apollo 14 ALSEP Tests	5-4
Apollo 15 ALSEP Tests	5-5
Apollo 16 ALSEP Tests	5-6
Apollo 17 ALSEP Tests	5-6
OVERLOAD AND "RIPPLE OFF" TESTS	5-7
Summary	5-7
Discussion	5-8
PSE-HEATER POWER TESTS	5-9
Summary	5-9
Discussion	5-10
CENTRAL STATION COLD-TEMPERATURE TESTS	5-11
Summary	5-11
Discussion	5-12

Section	Page
CENTRAL STATION REDUNDANT COMPONENT TESTS	5-12
Summary	5-13
Discussion	5-13
TIMER "TIMEOUT" TESTS	5-14
Summary	5-14
Discussion	5-14
COLD SOAKING THE LSM AND LSG EXPERIMENTS	5-14
Summary	5-14
Discussion	5-15
CANCELED TESTS	5-15
CENTRAL STATION CONFIGURATION AT TERMINATION OF ALSEP OPERATIONAL SUPPORT	5-17
6. SIGNIFICANT ALSEP SCIENTIFIC RESULTS	6-1
PASSIVE SEISMIC EXPERIMENT	6-2
Lunar Seismicity (By Gary V. Latham)	6-2
Structure of the Moon (By Nafi Toksöz)	6-3
LUNAR NEAR-SURFACE STRUCTURE (ACTIVE SEISMIC)	6-4
By Robert L. Kovach	
LUNAR SURFACE MAGNETOMETERS	6-5
Lunar Electrical Conductivity and Structure	6-5
(By Palmer Dyal)	
Apollo 12 and 15 Magnetometers (By C. P. Sonett)	6-8
SUPRATHERMAL ION DETECTOR EXPERIMENT	6-9
By John W. Freeman, Jr.	
LUNAR HEAT FLOW EXPERIMENT	6-10
By Marcus G. Langseth	
CHARGED PARTICLE LUNAR ENVIRONMENT EXPERIMENT	6-12
By David L. Reasoner	

Section	Page
COLD CATHODE GAGE EXPERIMENT By Francis S. Johnson	6-14
LUNAR ATMOSPHERIC COMPOSITION EXPERIMENT By John H. Hoffman	6-14
LUNAR SURFACE GRAVIMETER EXPERIMENT By Joseph Weber	6-15
SOLAR WIND SPECTROMETER By Conway W. Snyder	6-15
LUNAR EJECTA AND METEORITES By Otto E. Berg	6-16
7. SIGNIFICANT OPERATIONAL DATA (INCREASING TEMPERATURE) . . .	7-1
8. RECOMMENDATIONS	8-1
9. BIBLIOGRAPHY	9-1
APPENDIX A -- LIST OF ACRONYMS	A-1

1. INTRODUCTION

The Apollo Lunar Surface Experiments Package (ALSEP) was a completely self-contained science station deployed and activated by the Apollo astronauts and left on the lunar surface. The ALSEP collected scientific data on the lunar surface and transmitted the data to Earth where the information was collected as part of the ALSEP support operations. A forerunner of ALSEP, known as the Early Apollo Scientific Experiment Package (EASEP), was deployed by the Apollo 11 crew. The EASEP differed from the ALSEP in that its power was from solar cells, also the EASEP contained only one experiment (Passive Seismic Experiment (PSE)).

The objective of this ALSEP Termination Report is to document the ALSEP operations beginning with the first Apollo landing on the Moon (July 20, 1969) and ending with the termination of support operations on September 30, 1977. It is a summary report describing the ALSEP central stations and experiments, deployment, operations, performance, final tests and results, status at termination, and science summary.

ALSEP LOCATIONS AND START TIMES

Locations of the ALSEP stations on the Moon are shown in figure 1-1, and table 1-I is a matrix showing the ALSEP experiments and the Apollo missions during which the equipment was deployed. Lunar coordinates of the deployed ALSEP stations are as follows:

<u>Apollo mission no.</u>	<u>Landing site</u>	<u>Lunar coordinates</u>
11	Mare Tranquillitatis	23.4° E, 0.7° N
12	Oceanus Procellarum	23.5° W, 3.0° S
13	(Lunar landing aborted)	(Lunar landing aborted)
14	Fra Mauro	17.5° W, 3.7° S
15	Hadley Rille	3.7° E, 26.1° N
16	Descartes	15.5° E, 9.0° S
17	Taurus Littrow	30.8° E, 20.2° N

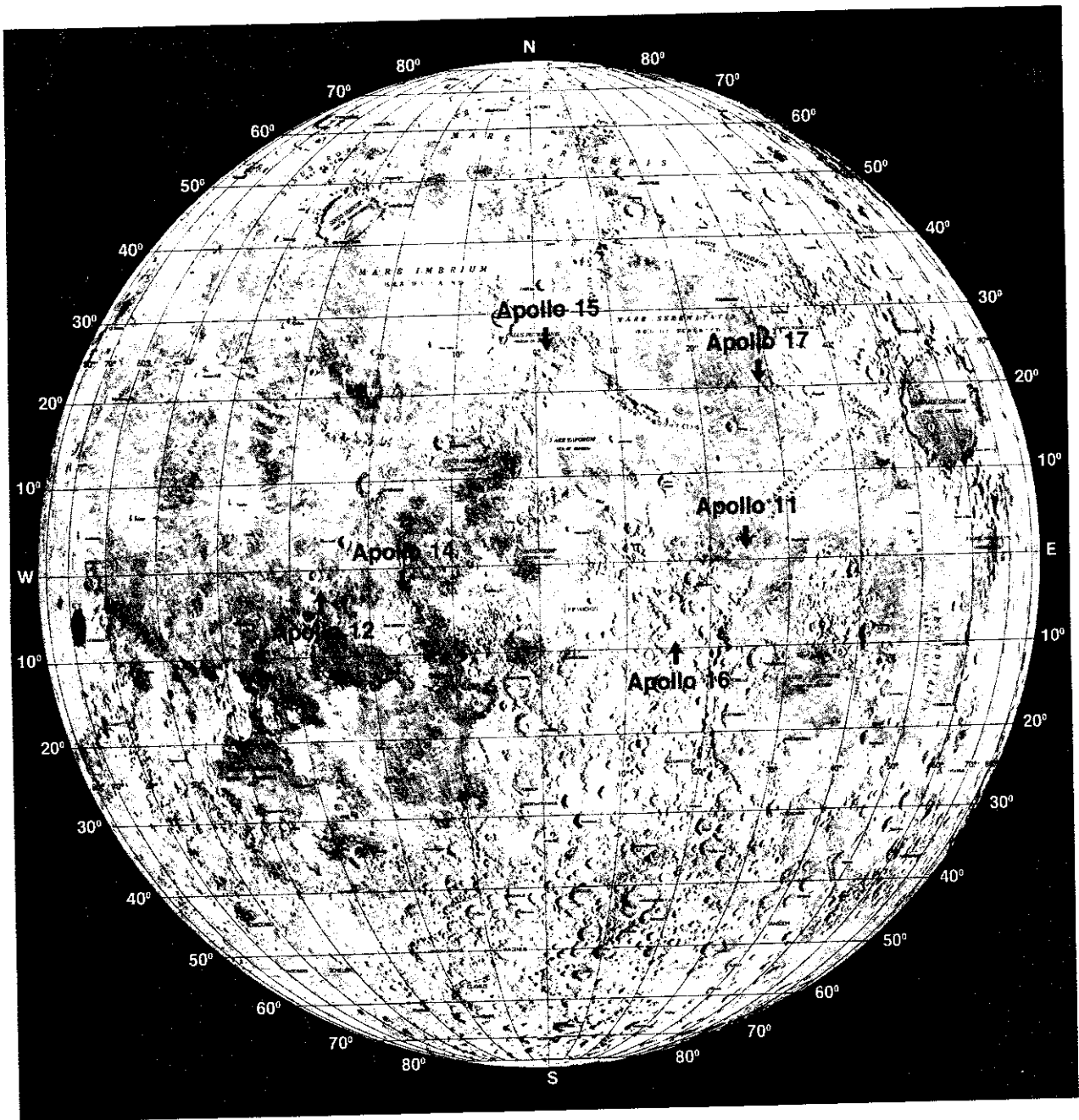

Figure 1-1.- ALSEP locations on the Moon.

TABLE 1-I.- ALSEP EXPERIMENTS AND APOLLO MISSION ASSIGNMENTS

Experiment	Apollo mission					
	11	12	14	15	16	17
Passive Seismic	X	X	X	X	X	
Active Seismic			X		X	
Lunar Surface Magnetometer		X		X	X	
Solar Wind Spectrometer		X		X		
Suprathermal Ion Detector		X	X	X		
Heat Flow				X	X	X
Charged Particle			X			
Cold Cathode Gage		X	X	X		
Lunar Ejecta and Meteorites						X
Lunar Seismic Profiling						X
Lunar Mass Spectrometer						X
Lunar Surface Gravimeter						X
Dust Detector	X	X	X	X		

The dates and times (universal time (UT)) of initial downlink acquisition from the ALSEP stations were as follows:

<u>Apollo mission:</u>	<u>Start date:</u>	<u>Time, UT</u>
11	July 21, 1969	04:41
12	Nov. 19, 1969	14:21
14	Feb. 5, 1971	17:23
15	July 31, 1971	18:37
16	Apr. 21, 1972	19:38
17	Dec. 12, 1972	02:53

PROGRAM INFORMATION SUMMARY

The program objectives were to acquire scientific data to aid in determining

1. Internal structure and composition of the Moon
2. Composition of the lunar atmosphere
3. New insights into the geology and geophysics of Earth
4. State of the interior of the Moon
5. Genesis of lunar surface features

Program management was under the direction of the NASA Lyndon B. Johnson Space Center, Houston, Texas; the prime contractor was Bendix Aerospace Systems Division, Ann Arbor, Michigan. Major subcontractors were A. D. Little, Bendix Electrodynamics, Bendix Research Labs, Bulova, Dynatronics, General Electric Valley Forge, Geotech, Gulton, Motorola, Philco-Ford, Space Ordnance Systems, Teledyne Earth Sciences, Time Zero, and University of Texas at Dallas.

Principal Investigators for the various experiments were as follows:

<u>Experiment</u>	<u>Apollo mission</u>	<u>Principal Investigator</u>
Passive Seismic Experiment	11 to 16	Gary Latham Univ. of Texas
Lunar Surface Magnetometer	12, 15, & 16	Palmer Dyal Ames Research Center Charles Sonett Univ. of Arizona

<u>Experiment</u>	<u>Apollo mission</u>	<u>Principal Investigator</u>
Solar Wind Spectrometer	12 & 15	Conway Snyder Jet Propulsion Laboratory
Suprathermal Ion Detector Experiment	12 to 15	John Freeman Rice University
Heat Flow Experiment	15 to 17	Mark Langseth Lamont Doherty Geological Observatory Columbia University
Charged Particle Lunar Environment Experiment	14	David Reasoner Rice University Brian O'Brien Australian Government
Cold Cathode Gage Experiment	12, 14 & 15	Francis Johnson Univ. of Texas at Dallas
Active Seismic Experiment	14 & 16	Robert Kovach Stanford University
Lunar Seismic Profiling Experiment	17	Robert Kovach Stanford University
Lunar Surface Gravimeter	17	Joseph Weber Univ. of Maryland
Lunar Mass Spectrometer	17	John H. Hoffman Univ. of Texas at Dallas
Lunar Ejecta and Meteorites Experiment	17	Otto Berg Goddard Space Flight Center
Dust Detector	11, 12, 14, & 15	James Bates Lyndon B. Johnson Space Center Brian O'Brien Australian Government

ALSEP CONFIGURATIONS

The ALSEP central stations and related experiments were deployed on the lunar surface during six of the Apollo missions. Figures 1-2 to 1-6 give ALSEP deployment configurations for Apollo missions 12, 14, 15, 16, and 17.

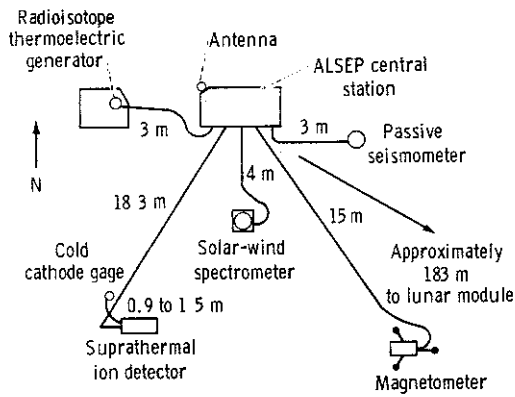

Figure 1-2.- Deployment configuration for Apollo 12 ALSEP.

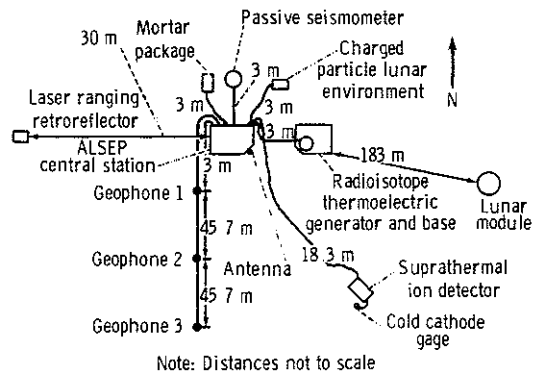
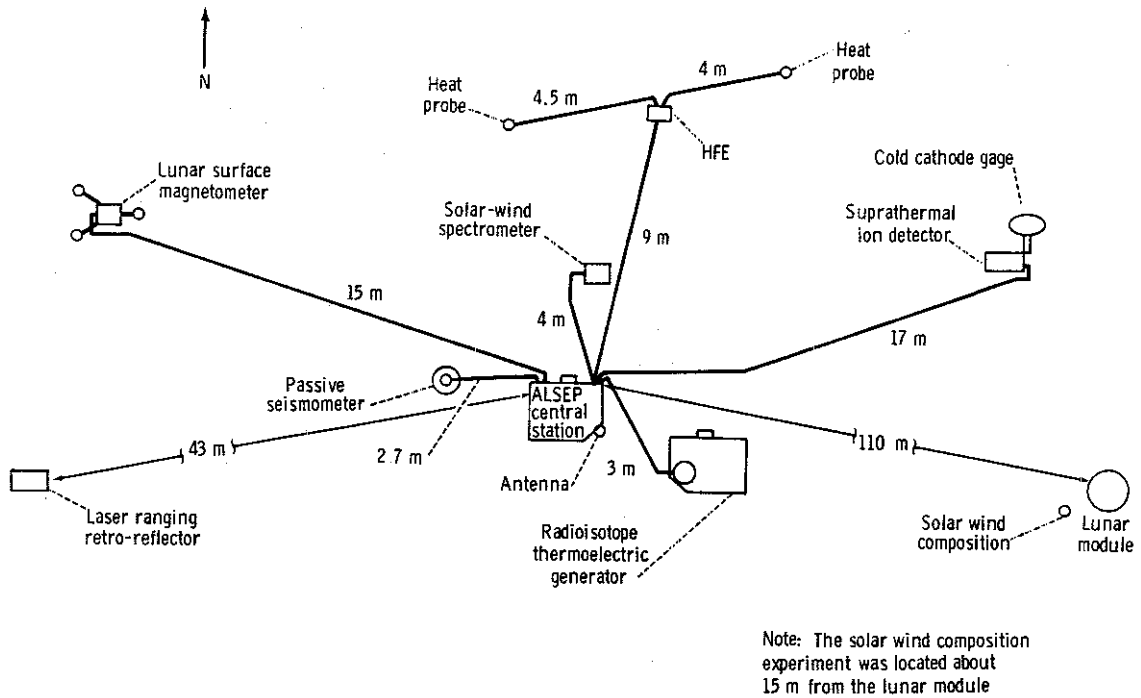

Figure 1-3.- Deployment configuration for Apollo 14 ALSEP.



Note: The solar wind composition experiment was located about 15 m from the lunar module

Figure 1-4.- Deployment configuration for Apollo 15 ALSEP.

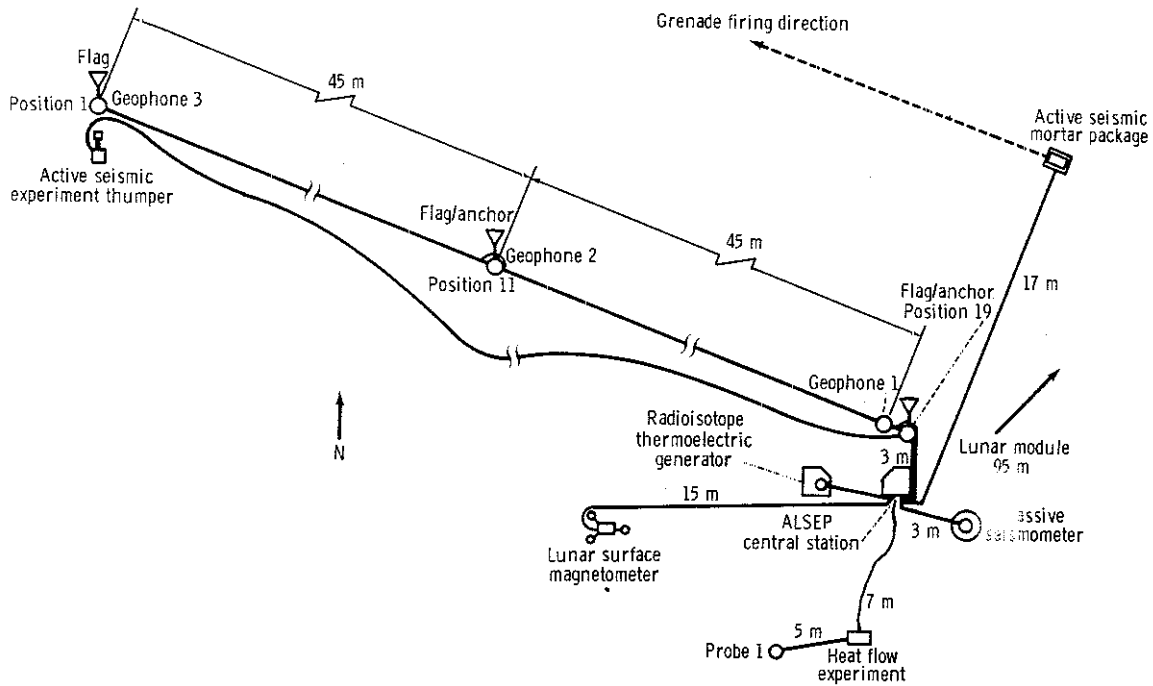

Figure 1-5.- Deployment configuration for Apollo 16 ALSEP.

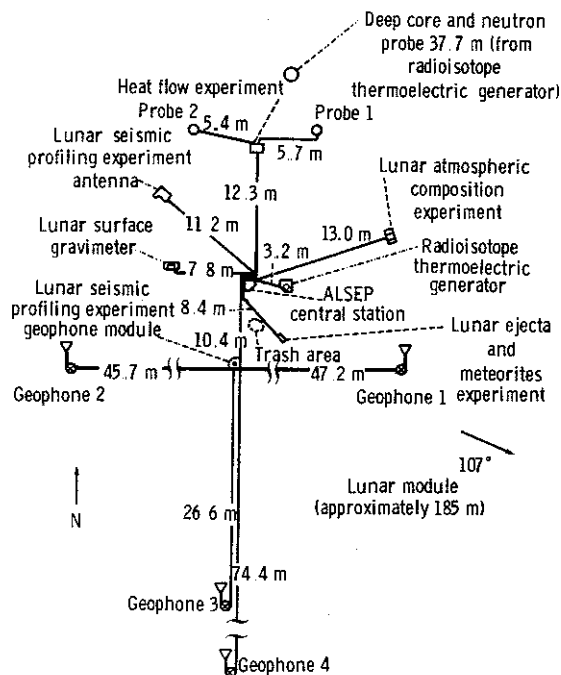

Figure 1-6.- Deployment configuration for Apollo 17 ALSEP.

2. ALSEP DESCRIPTION

All the Apollo Lunar Surface Experiments Packages (ALSEP's) and representative subsystems that were deployed during the six lunar landings are shown as a montage of illustrations in figure 2-1. Each item is identified by a "number key" in parentheses and is described in the following paragraphs.

SYSTEM CHARACTERISTICS

Central Station (1)

The central station was the heart of ALSEP; it provided the radio frequency (RF) link to Earth for telemetering data, for command and control, and for power distribution to the experiments. (For a more detailed discussion of the central station, see the subsection entitled "Subsystems of Central Station.")

Mass, kg	25
Stowed volume, cm ³	34 800
Total power, W	73
Average data rate, bits/sec	33.1

Performance data: Transmits with 1 W between 2275 and 2280 MHz at 530, 1060, 3533, or 10 600 bits/sec. Uplink: 2119 MHz at 1000 bits/sec with 100 seven-bit commands. Power: 21 W.

Dust Detector (1a)

The dust detector, flown on the Apollo 11, 12, 14, and 15 missions, was a reconfiguration of the original experiment that was designed to measure the "then anticipated" heavy dust accumulations on lunar experiment packages. Subsequent findings showed the dust layer and resultant blowing of dust to be much less than expected. Therefore, the original configuration of the dust detector was expanded from a device measuring dust only to one measuring radiation effects and lunar reflectance temperatures in addition to the dust accretion. The dust detector was mounted on the central station, and the dust collector area was 2 by 2 cm.

Mass, kg	0.27
Total power, W	0.54

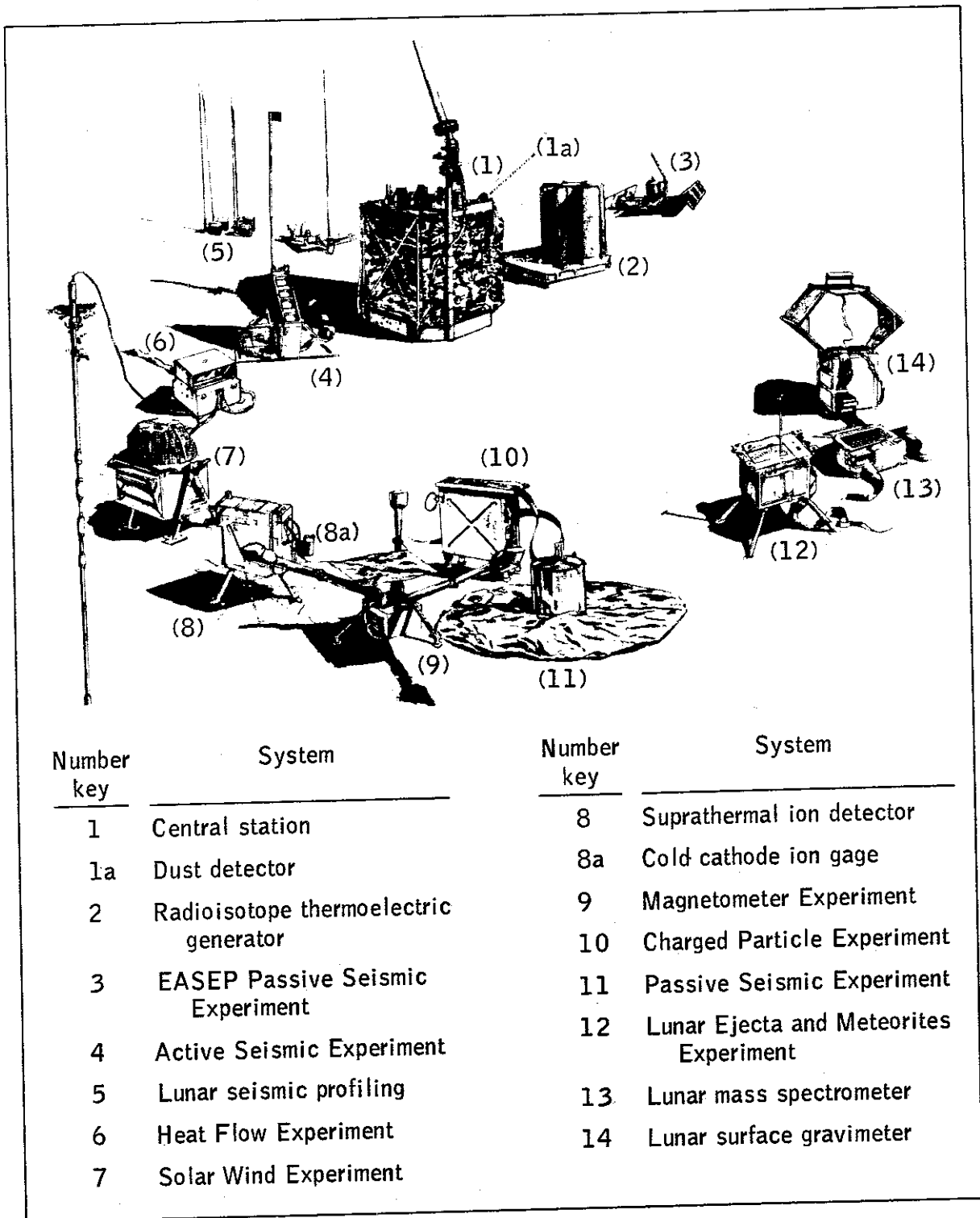

Figure 2-1.- Montage illustrating ALSEP subsystems.

Active Seismic Experiment (4)

The Active Seismic Experiment used an astronaut-activated thumper device and mortar firing explosive charges to generate seismic signals. This experiment used geophone seismic listening devices to determine lunar structure to depths of approximately 300 m.

Mass, kg	11.2
Dimensions	(see table 2-I)
Total power, W	9.75
Average data rate, bits/sec	10 000

Performance data: Thumper makes 2.2 N-sec (0.5 lb-sec) impulses. Mortar launches 45- to 454-g (0.1 to 1.0 lb) HNS grenades.

Lunar Seismic Profiling (5)

The Lunar Seismic Profiling Experiment, flown on Apollo 17 only, was an advanced version of the Active Seismic Experiment. It used four geophones to detect seismic signals generated by eight explosive charges weighing from approximately 0.06 to 3 kg. The charges were deployed at distances up to 3.5 km from the lunar module and were detonated by timers after the lunar module departed. Lunar structure to depths of 3 km was measured. When used in a listening mode, the experiment provided data on Moon/thermal quakes and meteoroid impacts.

Mass, kg	25.1
Dimensions, cm	27.9 x 24.1 x 25.4
Total power, W	6.8
Average data rate, bits/sec	3533

Performance data: Charges of 0.06 to 3 kg were deployed to distances up to 3.5 km.

Heat Flow Experiment (6)

Probes containing temperature sensors were implanted in holes to depths of 2.5 m to measure the near-surface temperature gradient and thermal conductivity from which the heat flow from the lunar interior can be determined.

Mass, kg	4.6
----------------	-----

TABLE 2-I.- DIMENSIONS AND WEIGHT OF ACTIVE SEISMIC EXPERIMENT

Subsystem or component	Parameter	Value
Thumper/geophone assembly	Length (folded), cm	36.8
	Weight, kg	3.44
Thumper	Length (deployed), cm	113.0
	Weight, kg	2.10
Geophones	(including cables and initiators)	
	Height (including spike), cm	12.2
	Diameter, cm	4.2
	Weight, kg	1.34
Mortar Package	(three geophones with cables)	
	Envelope height, cm	29.2
	Envelope width, cm	15.2
	Envelope length, cm	38.7
Mortar box assembly	Weight, kg	7.71
	Height, cm	29.2
	Width, cm	15.2
	Length, cm	38.7
Grenade launch assembly	Weight, kg	2.90
	(including antenna and cables)	
	Width, cm	22.9
	Length, cm	34.8
Grenades	Depth, cm	15.8
	Weight, kg	4.94
	(including grenades)	
	Cross section, cm	6.9
Central electronics assembly	Length, cm	11.7
	Weight ^a (total), kg	3.66
	Height, cm	7.0
	Width, cm	15.7
Mortar package pallet assembly	Length, cm	17.2
	Weight, kg	1.46
	Width, cm	61.0
	Length, cm	66.0
	Weight, kg	3.11

^aGrenades 1, 2, 3, and 4 weighed 1.21, 0.99, 0.77, and 0.69 kg, respectively.

Dimensions, cm 24 x 25 x 28
(Probe, stowed -- 8.6 x 11.4 x 64.8 cm)

Total power, W 9.0

Average data rate, bits/sec 16.55

Performance data: Temperature gradient of 1.0×10^5 K/cm resolution, $\pm 3.0 \times 10^{-5}$ accuracy. Conductivity of 20.9×10^9 to 4.2×10^6 J cm⁻¹ sec⁻¹ K⁻¹ (5×10^6 to 1×10^3 cal cm⁻¹ sec⁻¹ °C⁻¹).

Solar Wind Experiment (7)

The solar wind spectrometer measured the interaction between the Moon and the solar wind by sensing the flow direction and energies of both electrons and positive ions.

Mass, kg 5.7

Dimensions, cm 30.5 x 28.2 x 34.5
(deployed)

Total power, W 12.5

Average data rate, bits/sec 66.2

Performance data: Energy - electrons, 6 to 1330 eV; protons - 18 to 9780 eV. Flux - 2.5×10^6 to 2.5×10^{11} particles cm⁻² sec⁻¹.

Suprathermal Ion Detector (8)

The Suprathermal Ion Detector Experiment provided information on the energy and mass spectra of positive ions near the lunar surface.

Mass, kg 8.8

Stowed volume, cm³ 5750

Total power, W 10.0

Average data rate, bits/sec 82.8

Performance data: Particle velocity of 4×10^6 to 9.35×10^6 cm/sec; energy of 0.2 to 48.6 eV and 10 to 3500 eV; flux of 0 to 10^6 particles/sec.

Cold Cathode Ion Gage (8a)

The cold cathode ion gage was a separate experiment combined in an integrated package with item number 8. The experiment determined the density of neutral gas particles in the tenuous lunar atmosphere.

Mass, kg 5.7
Dimensions, cm 34.0 x 11.7 x 30.5
Total power, W 6.5
Average data rate, bits/sec 82.8

Performance data: Range of 133×10^{-6} to 133×10^{-12} N/m² (10^{-6} to 10^{-12} torr); accuracy of ± 50 percent for less than 133×10^{-10} N/m² (10^{-10} torr) and ± 30 percent for values greater than 133×10^{-10} N/m² (10^{-10} torr).

Magnetometer Experiment (9)

The lunar surface magnetometer measured the intrinsic remanent lunar magnetic field and the magnetic response of the Moon to large-scale solar and terrestrial magnetic fields. The electrical conductivity of the lunar interior is determined from measurements of the Moon's response to magnetic field step-transients. Three boom-mounted sensors measured mutually orthogonal components of the field.

Mass, kg 8.6
Stowed volume, cm³ 17 750
Total power, W 11.95
Average data rate, bits/sec 116

Performance data: Range of 0 to $\pm 400 \times 10^{-9}$ tesla, $\pm 0.2 \times 10^{-9}$ tesla (0 to ± 400 gamma, ± 0.2 gamma) dc to 1 Hz; gradient of 0.03×10^{-9} to 10^{-9} tesla/cm (0.03 to 1 gamma/cm).

Charged Particle Experiment (10)

The Charged Particle Lunar Environment Experiment measured the fluxes of charged particles, both electrons and ions, having energies from 50 to 50 000 eV. The instrument measured plasma particles originating in the Sun and low-energy particle flux in the magnetic tail of the Earth.

Mass, kg 2.5
Stowed volume, cm³ 2540

Total power, W 6.5

Average data rate, bits/sec 99.3

Performance data: Energy of 40 to 80 000 eV, flux of 10^5 to 10^{10} particles $\text{cm}^{-2} \text{sec}^{-1} \text{sr}^{-1}$.

Passive Seismic Experiment (11)

The Passive Seismic Experiment detected moonquakes and meteoroid impacts to provide data for determining the Moon's internal composition. (Also, see item 3.)

Mass, kg 11.4

Dimensions, cm diameter 23
height 29

Total power, W 7.1

Average data rate, bits/sec 712

Performance data: Seismic output of 1 to 10 micrometers; tidal output from 0.01 to 0.4 arcsec horizontal, 80×10^{-8} to $320 \times 10^{-8} \text{ m/sec}^2$ (80×10^{-6} to $320 \times 10^{-6} \text{ gal}$) vertical.

Lunar Ejecta and Meteorites Experiment (12)

The Lunar Ejecta and Meteorites Experiment had three detectors that measured energy, speed, and direction of dust particles; the detectors were oriented to face east, west, and up.

Mass, kg 7.4

Stowed volume, cm^3 19 480

Total power, W 6.6

Average data rate, bits/sec 33.1

Performance data: Particle velocity range of 1 to 75 km/sec; particle energy range of 1×10^{-7} to $1000 \times 10^{-7} \text{ J}$ (1 to 1000 ergs).

Lunar Mass Spectrometer (13)

A magnetic deflection mass spectrometer was used to identify lunar atmospheric components and their relative abundances.

Mass, kg 9.1

Stowed volume, cm^3 17 640

Total power, W	11.4
Average data rate, bits/sec	66.3

Performance data: Ranges of 1 to 4 amu and 12 to 110 amu; sensitivity of $133 \times 10^{-5} \text{ N/m}^2$ (10^{-5} torr).

Lunar Surface Gravimeter (14)

The lunar surface gravimeter measured and sensed changes in the vertical component of lunar gravity, using a spring mass suspension. It also provided data on the lunar tides.

Mass, kg	12.7
Stowed volume, cm^3	26 970
Total power, W	9.3
Average data rate, bits/sec	596.3

Performance data: Tidal, dc to 0.048 Hz; free modes, 0.00083 to 0.048 Hz; gravity to 1 part in 10^5 .

SUBSYSTEMS OF CENTRAL STATION

The ALSEP central station consisted of the following three subsystems: (1) structural/thermal subsystem, (2) data subsystem, and (3) electrical power subsystem.

Structural/Thermal Subsystem

The primary elements of the structural/thermal subsystem are illustrated in figure 2-2. Not shown in the figure are the four telescoping springs, one at each corner of the central station, that were extended during deployment to raise the sunshield and unfurl the side curtains and reflectors. The passive thermal control elements consisted of multilayer insulation, reflectors, thermal coatings, and the thermal plate to which the electronic packages were mounted. Active thermal control was provided by commandable external power dissipation resistors (fig. 2-3) that dissipated 7 W and/or 14 W external to the electronics compartment. Heaters that also could be commanded on and off provided 5 or 9.4 W to be dissipated within the electronics compartment (fig. 2-4). Other heaters were automatically activated to simulate heat output of the transmitters or the receiver if they were turned off. Apollo 17 was unique in that there was an automatic power management system to maintain the electronics compartment within the 250 to 325 K (-10° to $+125^\circ$ F) desired temperature range.

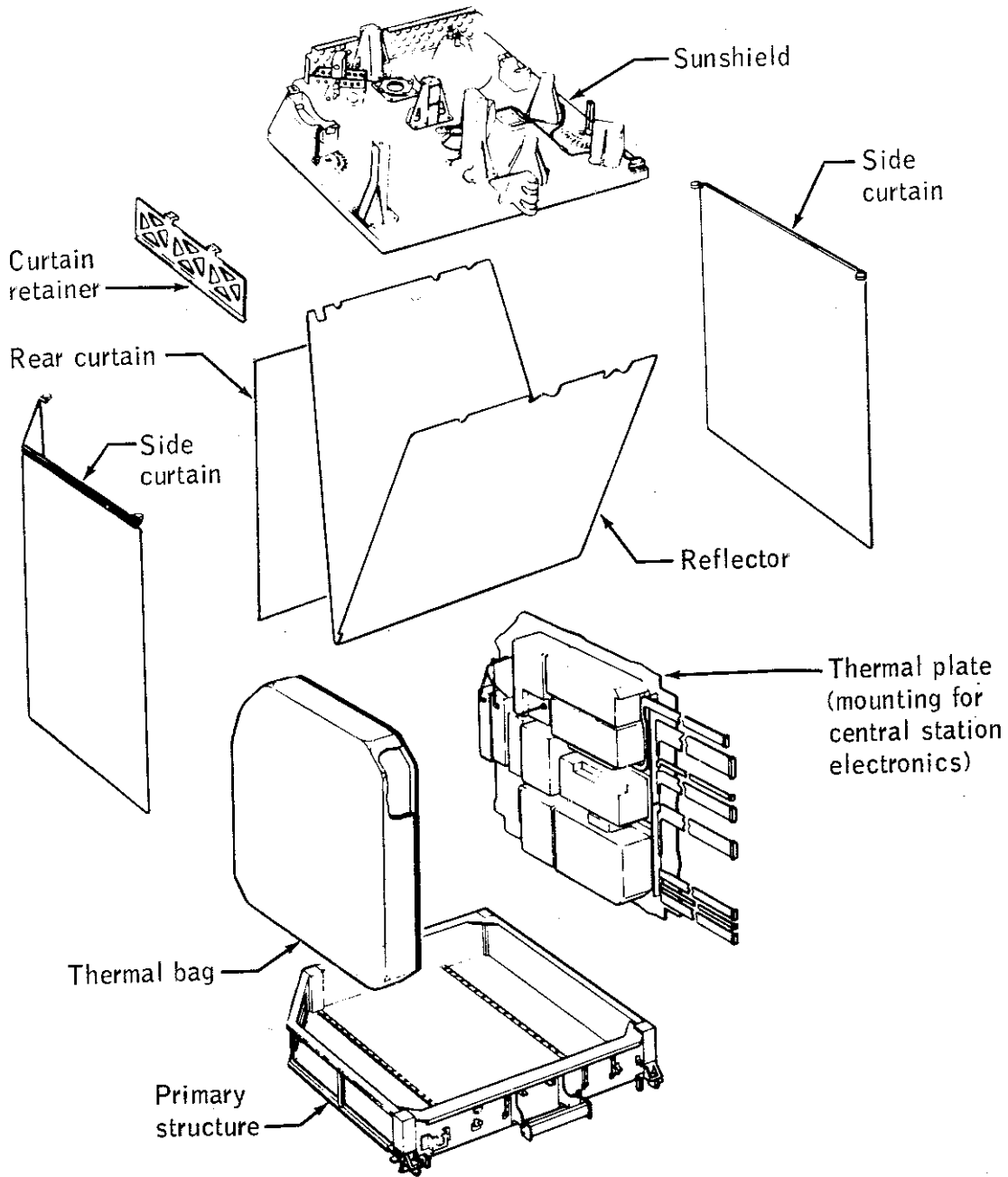

Figure 2-2.- Primary elements of the structural/thermal subsystem.

Number of resistors	Rating, ohms
3 in parallel	20 ea.
3 in parallel	20 ea.
1	121
1	64.9
<hr/> 8 total	

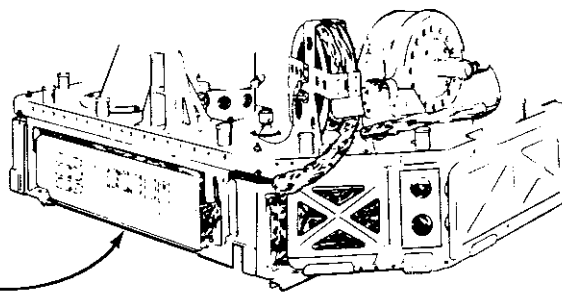

Figure 2-3.- Commandable external power dissipation resistors.

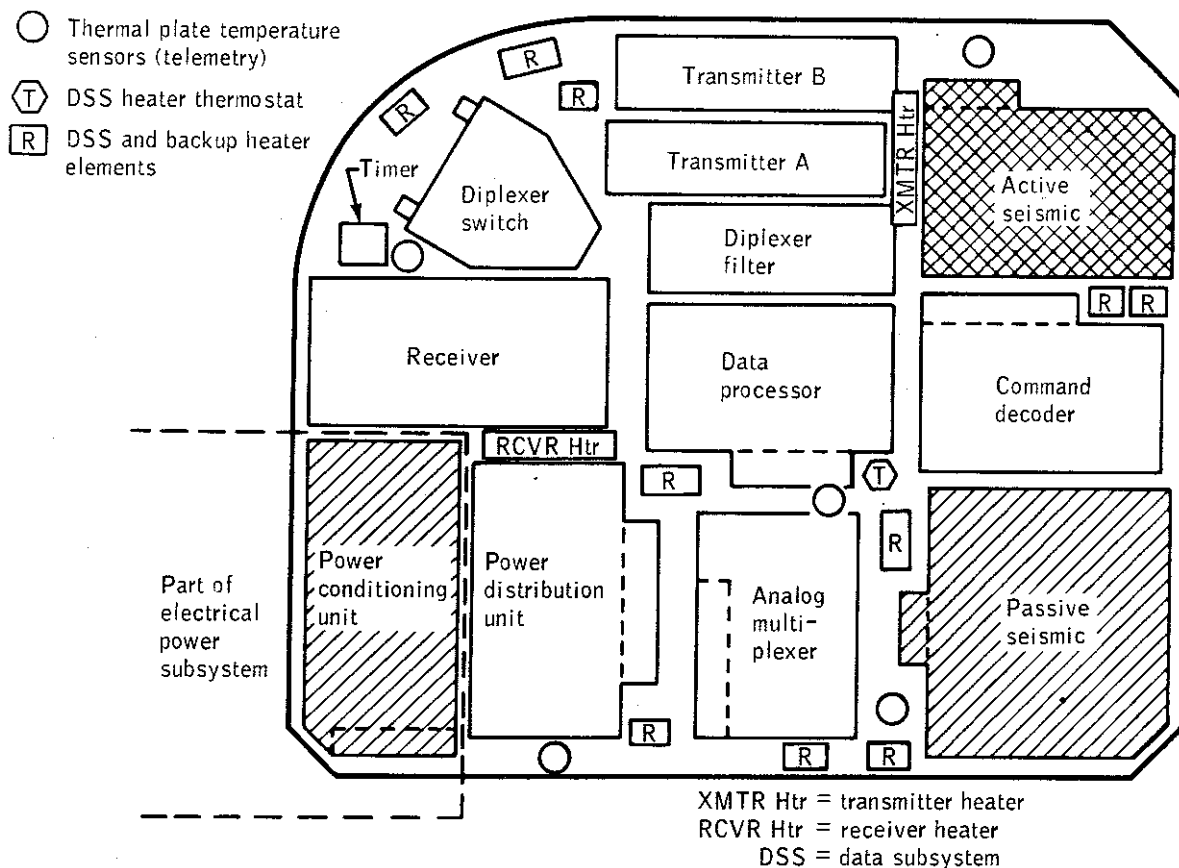
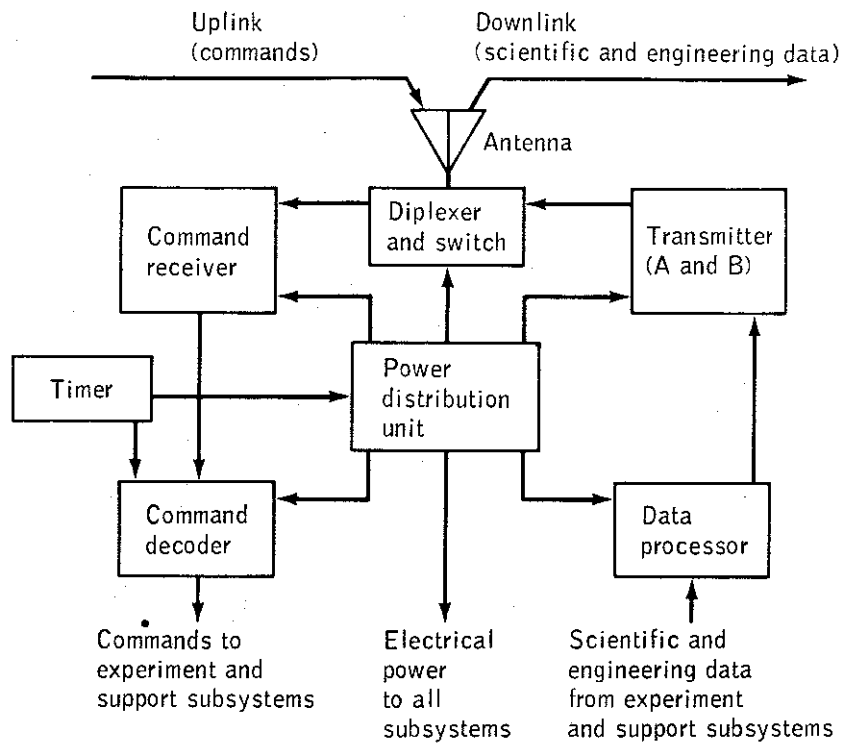

Figure 2-4.- Heaters of structural/thermal subsystem.

Data Subsystem

The data subsystem (DSS) components, except for the antenna and aiming mechanism, are mounted to the central station thermal plate as shown in figure 2-2. A block diagram of the DSS is shown in figure 2-5; its components and functions are as follows:

<u>Component</u>	<u>Function</u>
Power distribution and signal conditioner	Control of power switching as commanded and conditioning of engineering status data
Command decoder	Decode received signal and issue commands to the system
Data processor	Collect and format scientific data from the experiments; collect and convert analog housekeeping data into digital form
Command receiver	Accept and demodulate the Earth-to-Moon uplink signal
Transmitter	Generate Moon-to-Earth downlink signal
Diplexer switch	Connect either transmitter to the antenna
Diplexer filter	Connect receiver input and transmitter output to the antenna with required receiver-transmitter isolation
Central station timer	Provide automatic activation features (as a backup)
Antenna	Receive and radiate uplink and downlink RF signals
Antenna aiming mechanism (fig. 2-6)	For directing antenna to Earth
Central station heaters	Maintain temperature during lunar night (see fig. 2-4)



(a) Block diagram.

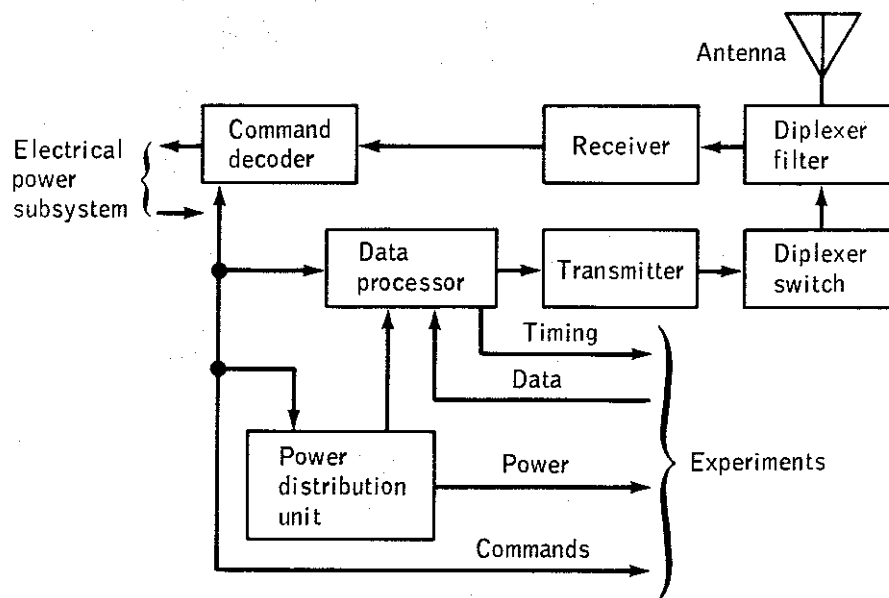

(b) Component diagram.

Figure 2-5.- Diagrams of ALSEP data subsystem.

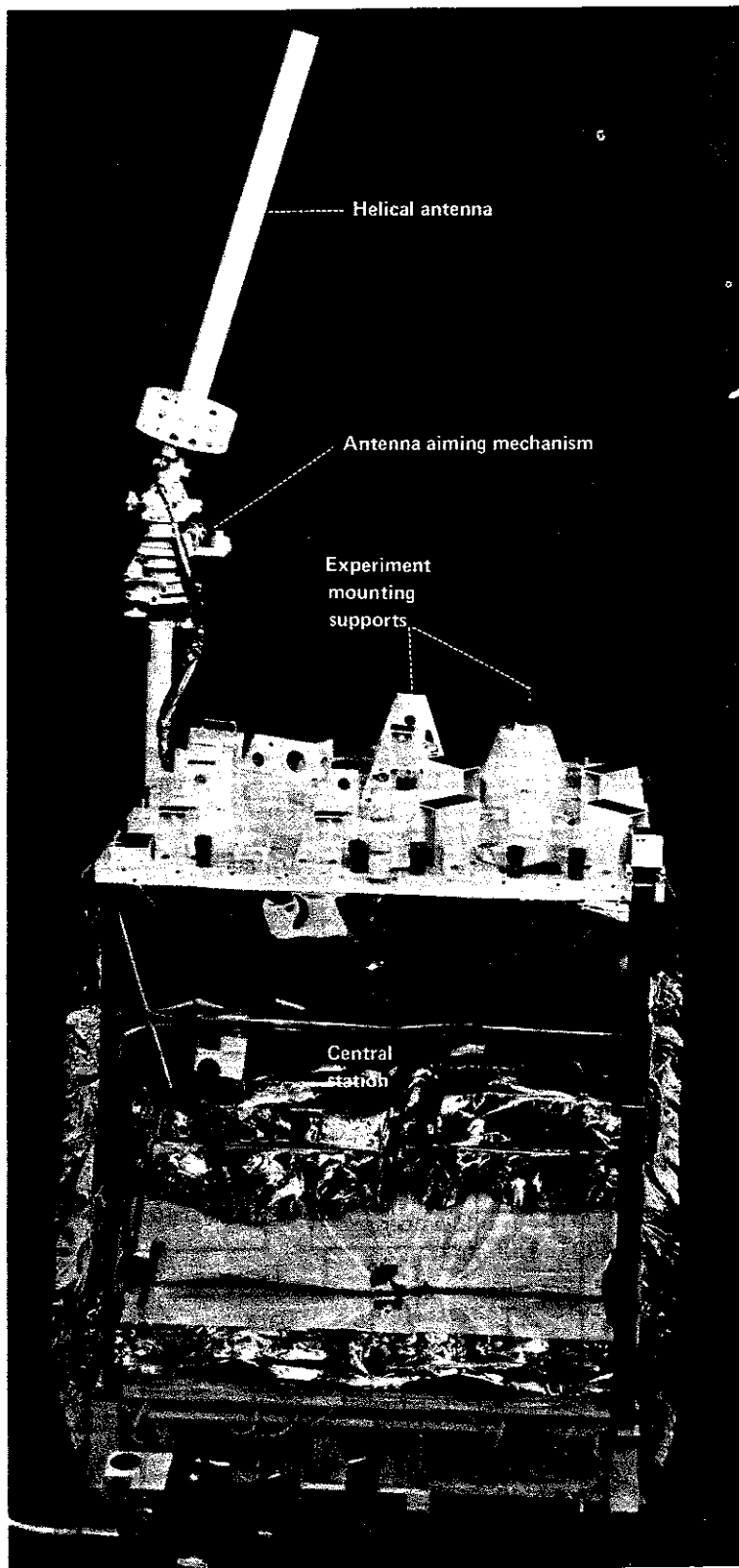

Figure 2-6.- Central station antenna.

Data subsystem antenna.- The central station antenna was the modified axial-helical type shown in figure 2-6. Antenna parameters were as follows:

Length, cm	58
Diameter, cm	3.8
Pitch, deg	15
Mass, g	580

The uplink frequency for all the Apollo missions was 2119 MHz; downlink frequencies were as follows:

<u>Apollo mission</u>	<u>Frequency, MHz</u>
12	2278.5
14	2279.5
15	2278.0
16	2276.0
17	2275.5

Data subsystem function.- The data subsystem received, conditioned, stored, and formatted the ALSEP scientific and engineering data that were then transmitted by an RF modulated signal to the manned space flight network (MSFN) receiving stations. Ground-based "command data" were also received by the data subsystem from the MSFN and were subsequently demodulated, decoded, and routed to appropriate ALSEP subsystems as separate discrete command functions. The signal processing functions of the data subsystems were for both uplink and downlink data.

Uplink: The ALSEP system was controlled from Earth by commands transmitted by MSFN stations. These commands were received as an RF signal input to the helical antenna and routed by the diplexer filter to the command receiver (fig. 2-5(b)). The command receiver demodulated the input carrier and provided a modulated subcarrier output to the command decoder. The command decoder processed this information, converted it into a digital format, and decoded the digital information into discrete ALSEP subsystem commands.

Downlink: Scientific and engineering status data were collected from experiment and supporting subsystems and routed to the data processor in both digital and analog forms. These data were collected according to a preprogrammed format stored in a programmable commutator. The analog signals were routed through a multiplexer to an analog-to-digital converter, where each analog input was converted into an 8-bit digital word and then combined with other digital data in a prescribed telemetry format. The digital output of the data processor was routed to the transmitter where it phase-modulated the RF carrier.

Portions of the downlink configuration were implemented with redundant sections either of which could be selected by command. Two separate transmitters were provided, either of which could also be selected by command. The Apollo 16 and 17 ALSEP stations contained redundant receivers.

Electrical Power Subsystem

The electrical power subsystem (EPS) provided the electrical power for lunar surface operation of the ALSEP. Primary electrical power was developed by thermoelectric action, with thermal energy supplied by a radioisotope source. The primary power was converted, regulated, and filtered to provide the six operating voltages for the ALSEP experiment and support subsystems.

Figure 2-7 is a block diagram of the EPS that consisted basically of the radioisotope thermoelectric generator (RTG) and the power conditioning unit (PCU). These two components are shown in figures 2-8 to 2-10. The power distribution unit (PDU), although a part of the data subsystem, is also described here; figure 2-11 is a block diagram of the PDU. A power control circuit for a typical ALSEP experiment is shown in figure 2-12.

The RTG, PCU, and PDU are described briefly in the following subsections. (Note that the Apollo 11 EASEP was powered by solar energy; see figure 2-1 and subsection entitled "EASEP Passive Seismic Experiment.")

Radioisotope thermoelectric generator.- The generator assembly (model, SNAP-27), with fuel capsule in place, weighed 17 kg (38 lb) and produced approximately 70 W (dc) at a nominal 16 V. Heat generated by decay of the plutonium-238 radioisotope fuel was transferred by radiation to a cylindrical hot frame in the generator. Spring loaded lead-telluride (Pb-Te) thermoelectric elements, mounted radially around the hot frame, converted heat directly to electrical power. These thermoelements were sealed in an inert atmosphere, and waste heat was rejected to a set of radiating fins. Whenever possible, beryllium was used as the main structural material to minimize the weight. Other materials included Inconel and Haynes superalloys for strength at high temperature. Thermoelements were connected in a series-parallel ladder arrangement to maximize reliability. Problems of misalignment under thermal cycling (lunar day-night variation) were reduced by incorporating a spherical seat at the outer end of each element. Design characteristics of the RTG are summarized as follows:

1. Conversion concept: Plutonium-238 (half life of 89.6 years) fueled a Pb-Te thermoelectric system.
2. Design life: 1 year for all missions except Apollo 17, which had a design life of 2 years.
3. Design power: 63.5 W at end of design life of 1 year (2 years for Apollo 17).

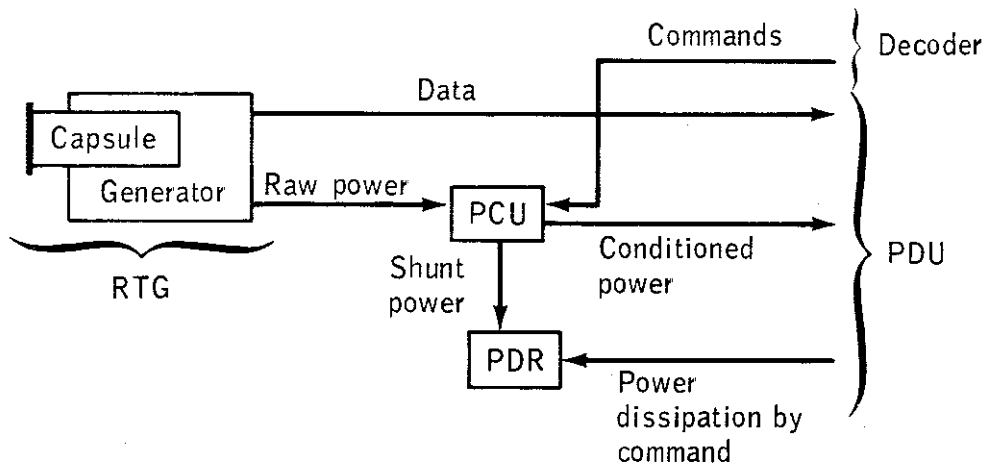

PDR = power dissipation resistors

Figure 2-7.- Block diagram of electrical power subsystem.

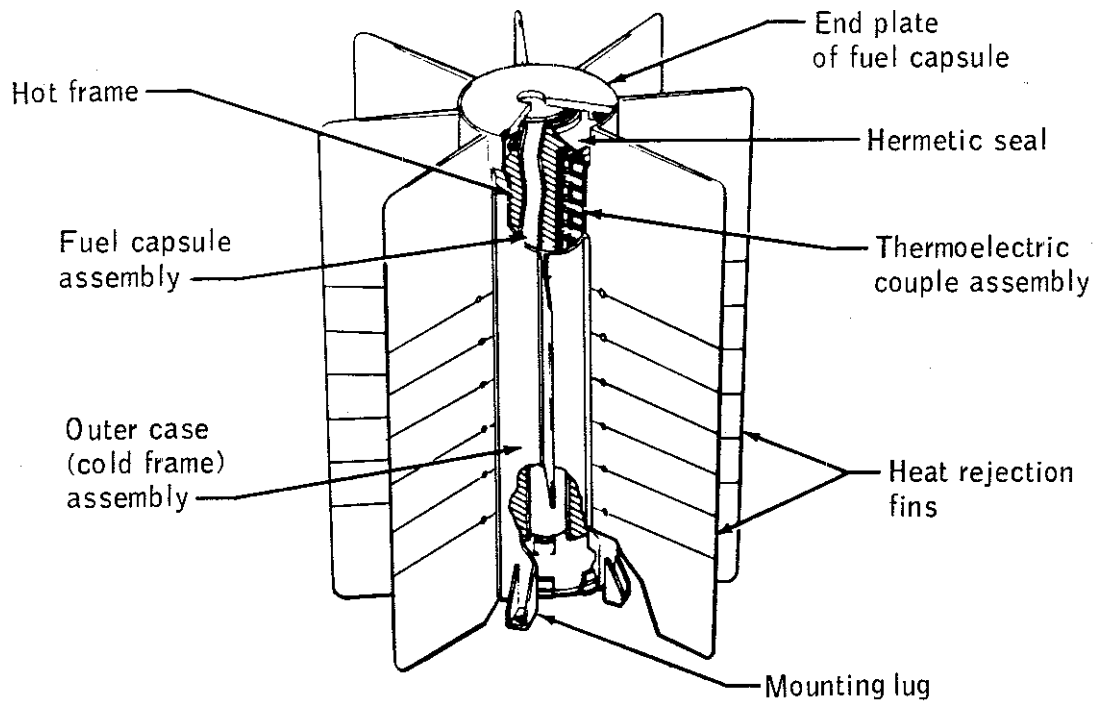
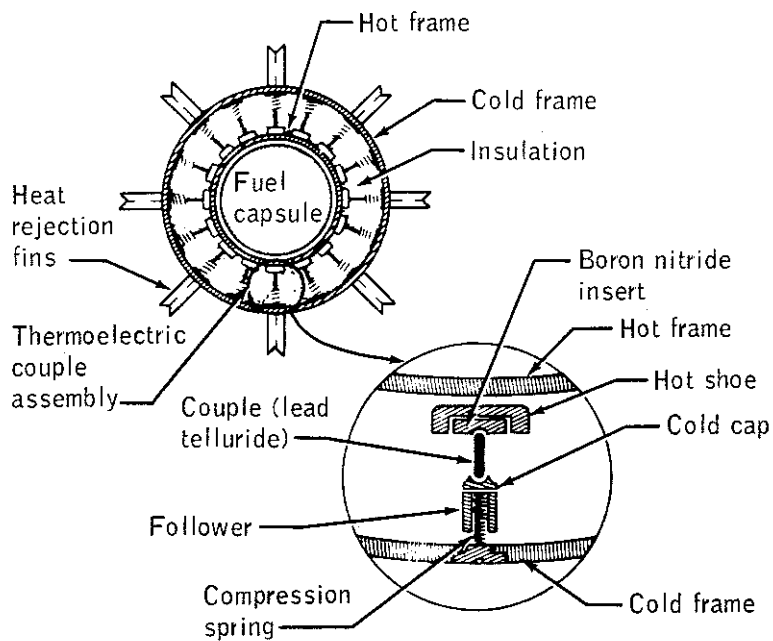
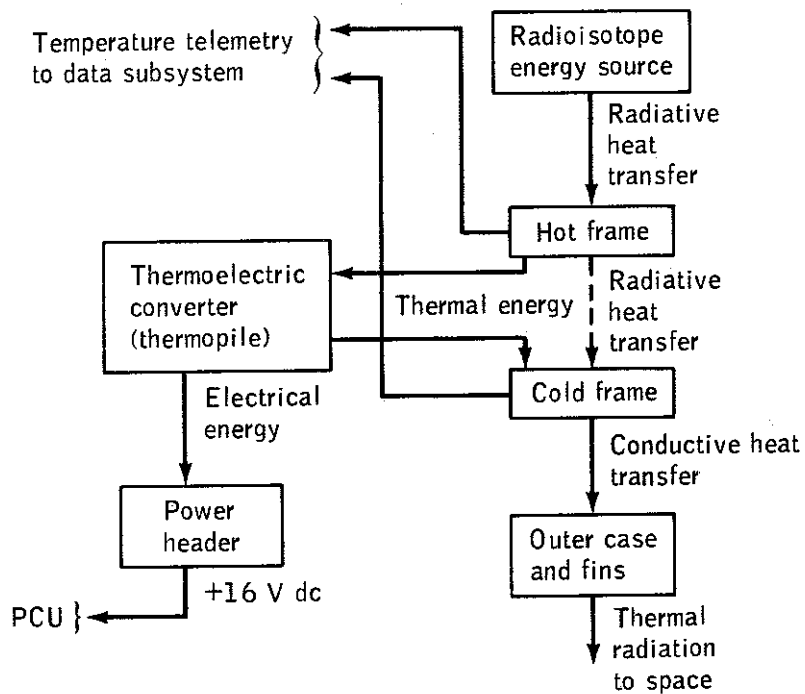

Figure 2-8.- Cutaway view of SNAP-27 radioisotope thermoelectric generator.



(a) Component schematic.



(b) Block diagram.

Figure 2-9.- Schematic and characteristics of SNAP-27 radioisotope thermoelectric generator.

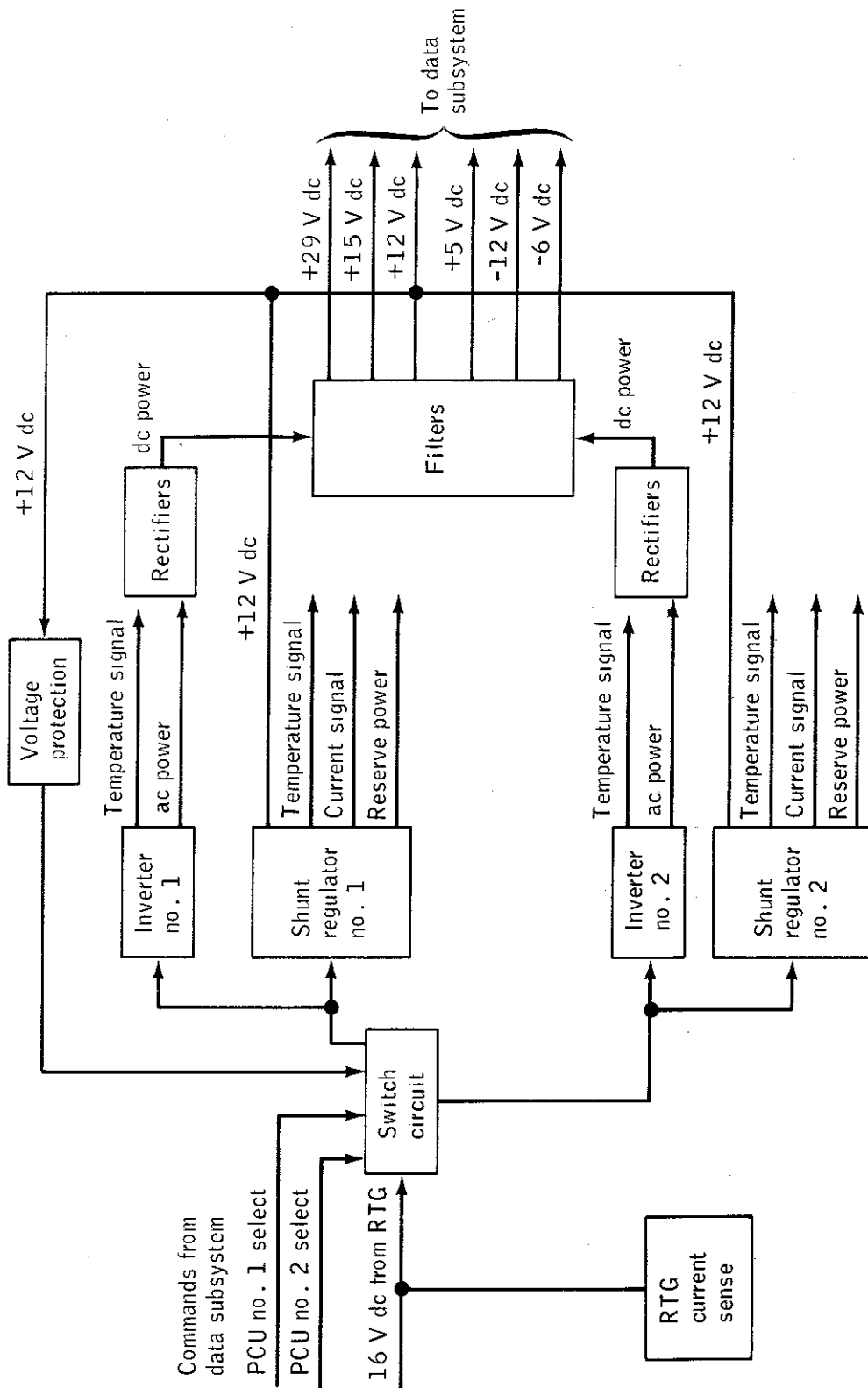

Figure 2-10.- Block diagram of power conditioning unit.

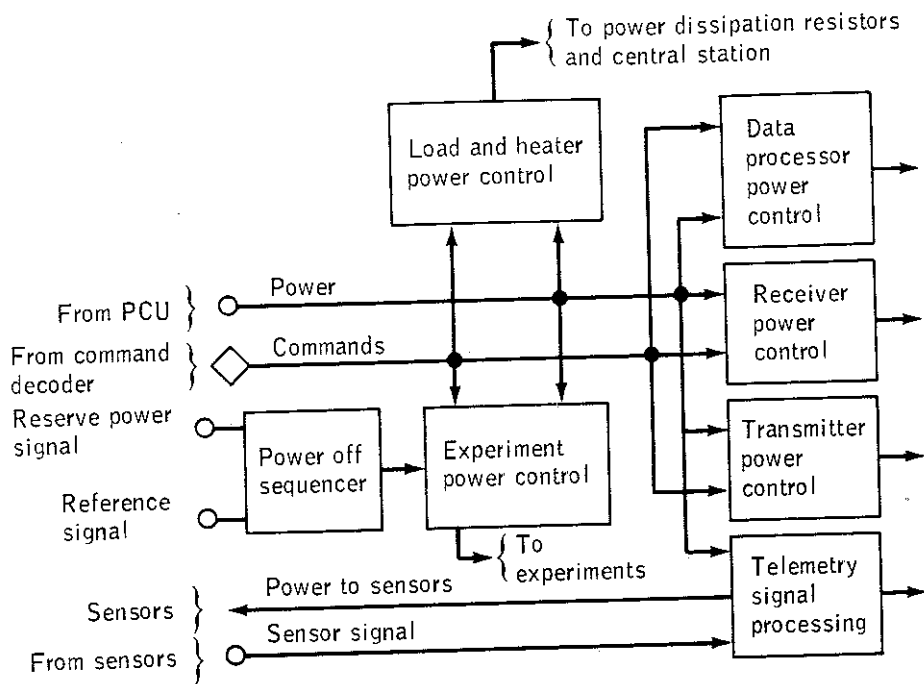

Figure 2-11.- Block diagram of power distribution unit.

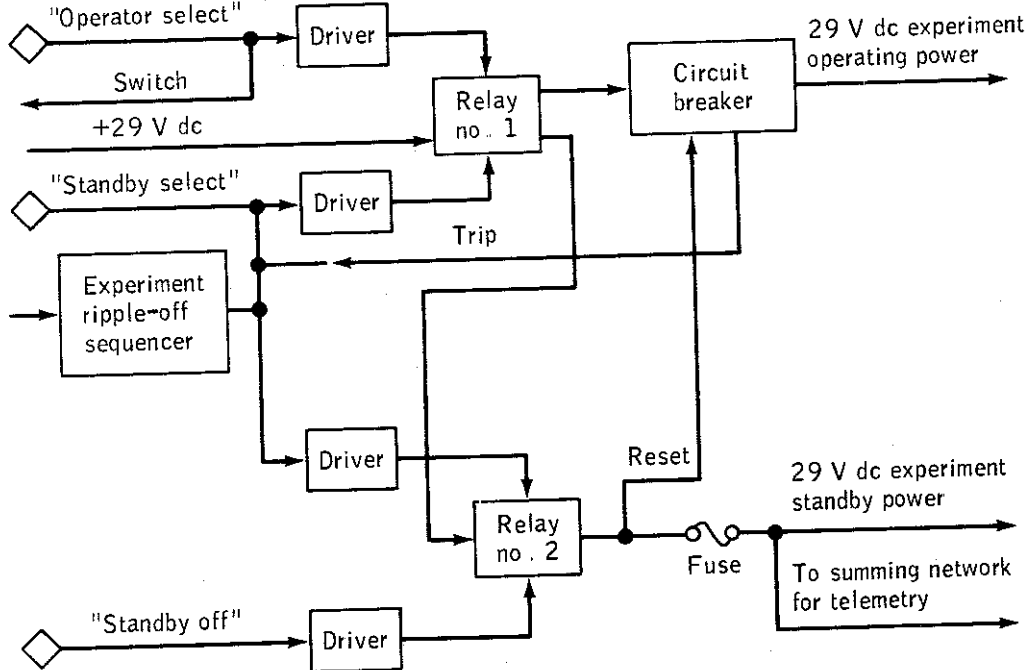

Figure 2-12.- Power control circuit for typical ALSEP experiment.

4. Physical characteristics:

Outer dimensions, cm (in.)	46 by 40 (18.1 by 15.7)
Number of thermoelectric couples	442
Generator weight, kg (lb)	12 (26)

5. Nominal operating temperatures were as follows:

Hot junction:

Lunar midnight, K (°F)	839 (1050)
Lunar noon, K (°F)	866 (1100)

Cold junction:

Lunar midnight, K (°F)	533 (500)
Lunar noon, K (°F)	505 (450)

Power conditioning unit.- The PCU performed three major functions: (1) voltage conversion, (2) voltage regulation, and (3) RTG protection. A block diagram of the PCU is shown in figure 2-10. Each power conditioner consisted of a dc-to-dc power converter (inverter and rectifiers), which converted the RTG 16-V input to the six operating voltages, and a shunt current regulator to maintain the output voltages within approximately ± 1 percent. This also regulated the input voltages and thus maintained a constant load on the RTG. It was necessary to maintain a constant load on the generator to prevent overheating of the thermocouples in the RTG.

As indicated in the block diagram, the +16 V from the RTG was applied through the switching circuit to the selected dc-to-dc converter, applying power to the inverter and completing the shunt regulation circuit. Applying power to the inverter permitted it to supply ac power to the rectifiers that developed the dc voltages applied to the filters. The outputs from the filters were the six operating voltages applied to the data subsystem. Output and input voltages were regulated by feedback from the +12 V output to the shunt regulator. The +12-V feedback was also applied to the switching circuit for over or under voltage determination and for switching to the redundant inverter and regulator, if necessary. All the output voltages were regulated by the 12-V feedback.

Power distribution unit.- The PDU (figs. 2-11 and 2-12) distributed power to experiment and central station subsystems and provided circuit overload protection and power switching of selected circuits. The PDU also provided signal conditioning of selected central station and RTG telemetry monitor signals prior to input to the analog multiplexer for analog-to-digital conversion and subsequent data transmission to Earth.

The power-off sequencer of the PDU detected minimum reserve power and sequentially placed up to three preselected experiments on "standby" to bring the power reserve within acceptable limits. The minimum reserve

power was detected by monitoring the voltage across the shunt regulator transistor. This voltage was applied to an operational amplifier used as a level detector. An RC delay network was used at the output of the level detector. The output of the delay was applied to a second level detector that drove the power-off sequencer logic. This arrangement turned on the power-off sequencer logic input gate when the reserve power dropped below the levels as follows: reserve power to start experiment turn-off (135 millisecond delay) was $0.78 \text{ W} \pm 0.57 \text{ W}$.

3. DATA MANAGEMENT AND ALSEP OPERATION

Control of the Apollo Lunar Surface Experiments Package (ALSEP) was accomplished through the Manned Space Flight Network (MSFN). The operational management and the data collection were a function of ALSEP Control Teams.

TRACKING STATIONS

The MSFN, a worldwide network of tracking stations, was in communication with the NASA Goddard Space Flight Center (GSFC) and the NASA Lyndon B. Johnson Space Center (JSC). A flow diagram of the communication network is shown in figure 3-1, and the ALSEP supporting stations and the equipment configuration are given in table 3-I. Command capability was through the MSFN ground stations with instructions from the Mission Control Center (MCC) at JSC; the technical coordination, e.g., station scheduling and so forth, was the responsibility of the GSFC Operation Manager (MSFNOM). The MSFN recorded ALSEP data on a continuous 24-hour/day basis and the recorded data were sent to JSC for processing and distribution to individual Principal Investigators (PI's).

ALSEP CONTROL TEAMS

Special Control Teams, directed by the ALSEP Senior Engineer (ASE), were assigned to each ALSEP; a functional diagram of the coordination effort is given in figure 3-2. The team responsibilities were as follows:

1. Coordinate ALSEP deployment and activation of the experiment equipment
2. Implement contingency procedures for crew activities during ALSEP deployment
3. Exercise operational control of ALSEP(s) after initial activation
4. Ensure maximum return of scientific data from the ALSEP equipment during its useful lifetime

The ALSEP Control Teams were responsible for preparing numerous documents based on data supplied by individual PI's, contractors, hardware vendors, and similar scientific personnel. The scope and extent of this planning effort are indicated in the following list of typical documents prepared for an ALSEP.

TABLE 3-I.- ALSEP SUPPORTING STATIONS AND EQUIPMENT CONFIGURATION

MSFN facility	Location	Unified S-band antenna for telemetry updata and tracking			High-speed telemetry data	Voice (SCAMAA)	TTY ^a	ALSEP RSDP ^a computer
		85-foot dual	30-foot single	30-foot dual				
MCC	Houston, Tex.					X	X	
MSFNOC ^a	Greenbelt, Md.					X	X	
ACN	Ascension Is.			X	X	X	X	X
ANG	Santiago, Chile		X		X	X	X	X
BDA	Bermuda		X		X	X	X	X
CRO	Carnarvon, Australia			X	X	X	X	X
CYI	Canary Is.		X		X	X	X	X
GBM	Grand Bahama		X		X	X	X	X
GYM	Guaymas, Mexico			X	X	X	X	X
GDS	Goldstone, Calif.	X			X	X	X	X
GWM	Guam Is.			X	X	X	X	X
HAW	Hawaii			X	X	X	X	X
HSK	Honeysuckle, Australia	X			X	X	X	X
MIL	Merritt Is., Fla.			X	X	X	X	X
MAD	Madrid, Spain	X			X	X	X	X
TEX	Corpus Christi, Tex.		X		X	X	X	X

^aNotes: SCAMA = switching, conferencing, and monitoring arrangement; TTY = teletype; RSDP = remote site data processor; MSFNOC = MSFN Operations Control.

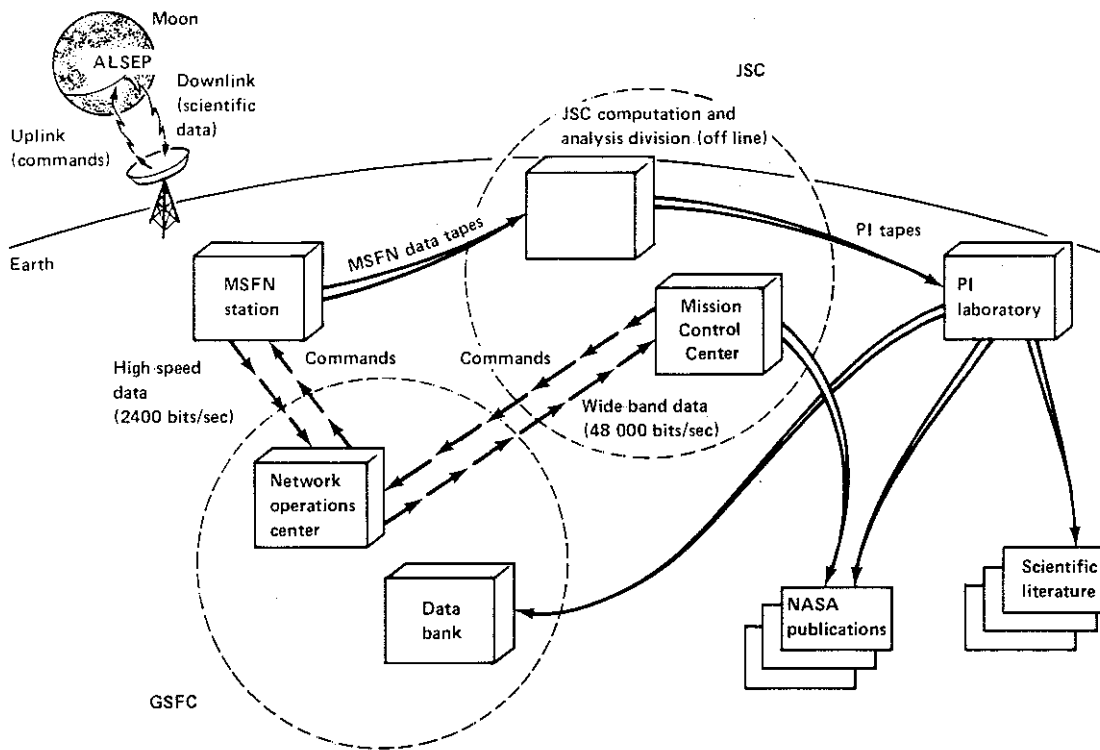

Figure 3-1.- ALSEP communication network.

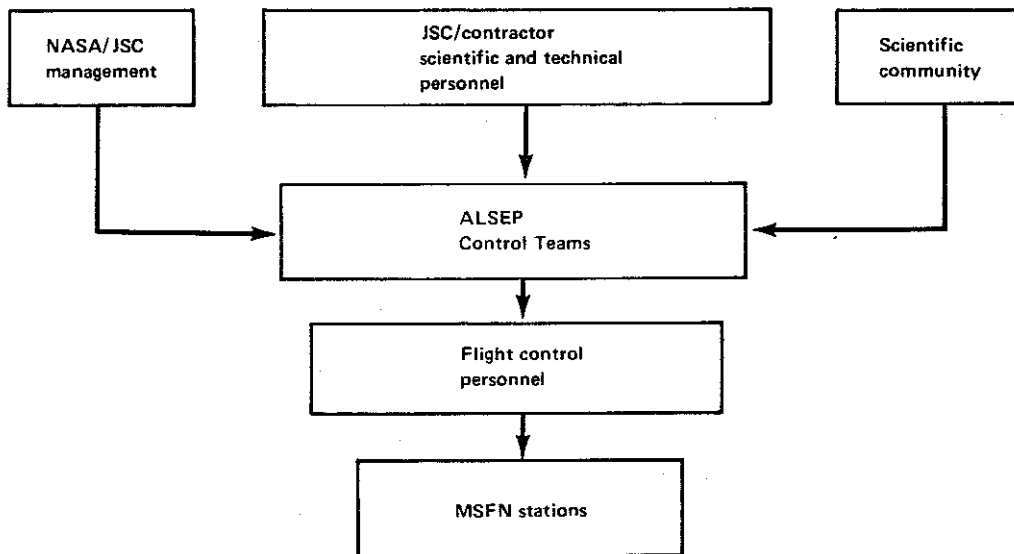

Figure 3-2.- Functional diagram of ALSEP coordination.

1. ALSEP Systems Handbook: The ALSEP Systems Handbook was a functional representation of ALSEP systems and was prepared in a format for real-time use by ALSEP controllers. The information enabled most contingencies to be determined and solved in real time.

2. ALSEP Mission Rules: The ALSEP Mission Rules were preplanned solutions and guidelines for single-point failures of the systems hardware.

3. Apollo Spacecraft Operational Data Book, Vol. VI (SODB): The SODB was a collection of hardware operational specifications; its primary use was the preparation of related documentation.

4. ALSEP Contingency Procedures: The ALSEP Contingency Procedures were a collection of alternatives to standard crew deployment procedures. The procedures were listed by system and experiment to enable their optimal use during the lunar deployment of ALSEP.

5. Lunar Surface Flight Plan: The Lunar Surface Flight Plan was that part of the overall Flight Plan that was used while the flightcrew was on the lunar surface. The flightcrew used this material in the format of a "cuff" check list.

6. ALSEP Console Handbook: The ALSEP Console Handbook was a collection of console operating procedures used by the ALSEP controllers in real-time support.

7. ALSEP Operations Report: The operations report was in two parts: (1) a summary support plan and (2) a parameter listing. The support plan was a weekly guide to the planned activities during real-time support. The parameter listing was completed from the last data obtained before termination of support.

8. ALSEP Mission Operational Documentation: Data for this type of document were collected during the mission and were prepared for ALSEP analysis and historical documentation.

9. Activity Planning Guide: This planning guide began at lunar module (LM) ascent stage impact and was a real-time support schedule and activity guide for all deployed ALSEP equipment.

10. Data Book: A Data Book for each ALSEP was kept in the Operation Rooms. A new Data Book was started for each ALSEP at its sunrise (Sun angle of zero). High-speed printer formats were placed in the Data Book in the following order: Central Station, Experiment 1, Experiment 2, Experiment 3, Experiment 4, and Experiment 5. The central station format had a "tab" placed on it with the following information: day of year, date, and universal time (Greenwich mean time). The formats were obtained at the beginning and end of each support period and at even universal-time hours. In the event of a contingency problem, a format of the contingency was placed in each book and a "tab" written in red stating the problem and experiment affected.

11. Console Log: The Console Log was a history of everything that occurred during the support periods. The log reflected all commanding and anomalies; it also detailed the accomplishments. Important information was written in red; routine information was in black.

12. Deployment Log: The Deployment Log was an account of all operations during the time period from initial deployment on the lunar surface to the beginning of normal ALSEP operation.

13. SPAN Mission Evaluation Action Request (SMEAR): A document, commonly known as SMEAR, was prepared for two reasons: (1) to determine the cause of ALSEP problems and (2) to request action from a supporting organization. (SPAN = spacecraft analysis)

FLIGHT CONTROLLER PERSONNEL

Coordination and direction of ALSEP systems during an actual Apollo mission was the responsibility of three flight controller positions.

1. ALSEP Senior Engineer (designated ASE) -- The ASE was responsible for directing all activity in the ALSEP control area (room 314) at the MCC. As described previously, he was also director of the ALSEP Control Team and its activities.

2. ALSEP Systems Engineer (designated SYSTEMS) -- During a given Apollo mission, this position provided real-time response to all questions or problems relative to ALSEP equipment or experiment systems.

3. ALSEP Data Engineer (designated DATA) -- The DATA position during an Apollo mission was responsible for real-time data acquisition and for response to real-time data problems or questions.

These positions were staffed by NASA and contractor personnel who were cross trained to achieve maximum flexibility with minimum manning. Because of the physical layout of display equipment in the ALSEP control area (room 314 in MCC), a minimum of two staff members were required for each support period.

OPERATION ROOMS

Configuration of the Operation Rooms changed slightly during the sequence of Apollo missions, but a generalized layout is illustrated in figure 3-3. The ALSEP control area was staffed by flight controller personnel; the office/support area was staffed by technical staff and experiment scientists. Console 88 was the center of operations and the communications loop required two "comm" positions in front of the console. A modified universal command system was used for real-time commands and the system consisted of two panels (command control module and digital select module).

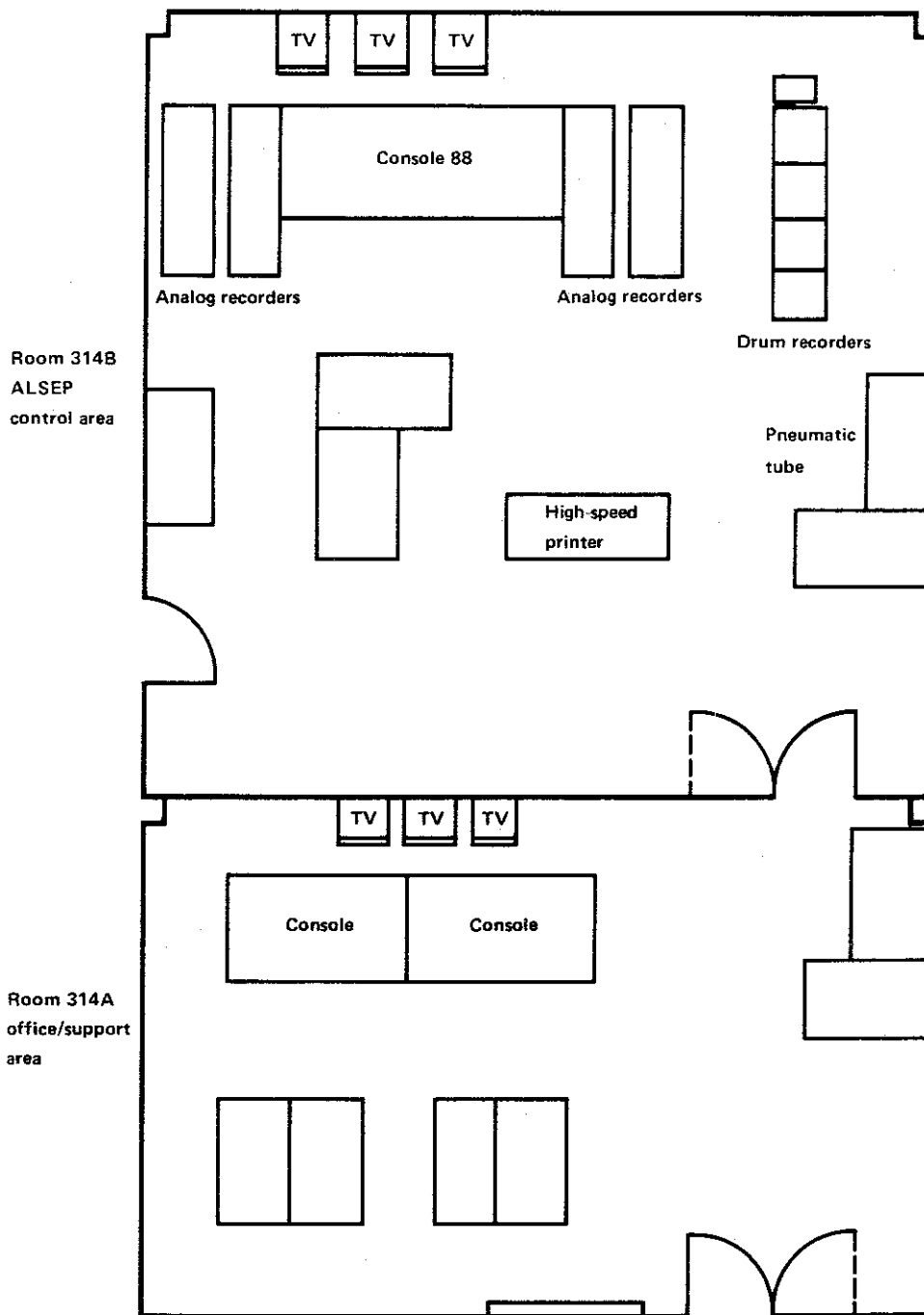

Figure 3-3.- Layout of ALSEP Operation Rooms.

Requirements called for receiving data simultaneously from two ALSEP central stations, and rapid access to hardcopy printouts was provided by a high-speed printer. Four (8 pen) analog recorders were provided for displaying data, and the capability existed for real-time switching between ALSEP's and between data formats. The data formats were defined and implemented before the mission. The eight drum recorders were provided with variable input filters and were dedicated for support of the Passive Seismic Experiment.

OPERATIONS PLANNING MEETINGS

Operations planning meetings were held periodically to discuss ALSEP status; also to decide the nature of future ALSEP operations and the schedule of these operations. The chairman of each meeting was a representative of the MCC Flight Director, and its members included representatives from (1) the JSC Science and Applications Directorate, (2) the JSC Lunar Science Program Office, (3) the PI's of the scientific community, (4) the ALSEP flight controllers, and (5) other representatives concerned with special aspects of a given mission.

REFERENCE FILE

During each Apollo mission, a reference file was maintained in the control area, and each file included the latest issues of the following three types of documents:

1. Operational documentation: This information included the operational documentation prepared by the ALSEP Control Teams or the related material based on these data.
2. Appropriate vendor and contractor material such as specifications, calibration curves, and so forth.
3. Data collected during ALSEP test and support periods.

ALSEP DATA

Real-Time Data to JSC

The data transmitted directly (hardlined) in real time to the ALSEP Operation Rooms in the MCC included high-speed printer copy, teletype copy, analog charts, drum recorder charts, and miscellaneous text prepared during real-time operations or as a result of these operations. These data were collected for either operational or scientific purposes, but no format distinction existed between the two groups. Classification can be based only on the intended use.

1. Operational data: Operational data were used to assess the operation of ALSEP systems and to provide a baseline for future operations.

2. Scientific data: Scientific data were distributed to the appropriate PI for cursory analysis; e.g., that the system was outputting valid and meaningful data.

Experiment Data

Telemetry data from the ALSEP stations on the lunar surface were recorded 24 hours a day by the worldwide tracking stations. Data were recorded on analog tapes that were then shipped from the tracking station to the JSC Computation and Analysis Division for further processing and distribution to the PI's (fig. 3-4). At JSC, the incoming analog tapes (range tapes) were processed with the CDC 3200 computer, and the output was a time-edited and computer-compatible digital tape. The digital tapes were then processed in a Univac 1108 computer to produce tapes with data for the specific ALSEP experiments needed by the various PI's. To preserve proprietary rights to the data, each tape contained only the data for a specific experiment. The time-edited digital tape was retained by the JSC Computation and Analysis Division until the PI had verified that the experiment tape was usable and another tape would not be required.

As the Apollo Program continued and more ALSEP stations were operating, the increased data flow impacted the Univac 1108 computer and data deliveries to the PI's were delayed by as much as 90 days. Processing procedures were then modified to use the CDC 3200 exclusively as shown in figure 3-5, but with no change in the PI tape format. This change reduced the waiting period and permitted a 45-day delivery to the PI.

For data collected up to March 1973, the raw-data analog tapes from the MSFN stations (range tapes) were archived at the Federal Record Center. Beginning in March 1973, the digital time-edited tapes (fig. 3-5) were stored as the archived data. By this time, more research was underway and the requests for archived data were increasing; therefore, the change to the direct computer-compatible digital tapes was implemented to reduce the costs of data retrieval.

By mid-1975, the analysis contracts with individual PI's were terminated (except for the Passive Seismic Experiment). However, data flow from five stations on the lunar surface continued and the cost of data processing remained constant. To decrease the cost of this function, data processing was transferred to the University of Texas at Galveston where newer, smaller, and more versatile computers and equipment could be used. The transfer was completed in March 1976, and the processing flow diagram is shown in figure 3-6.

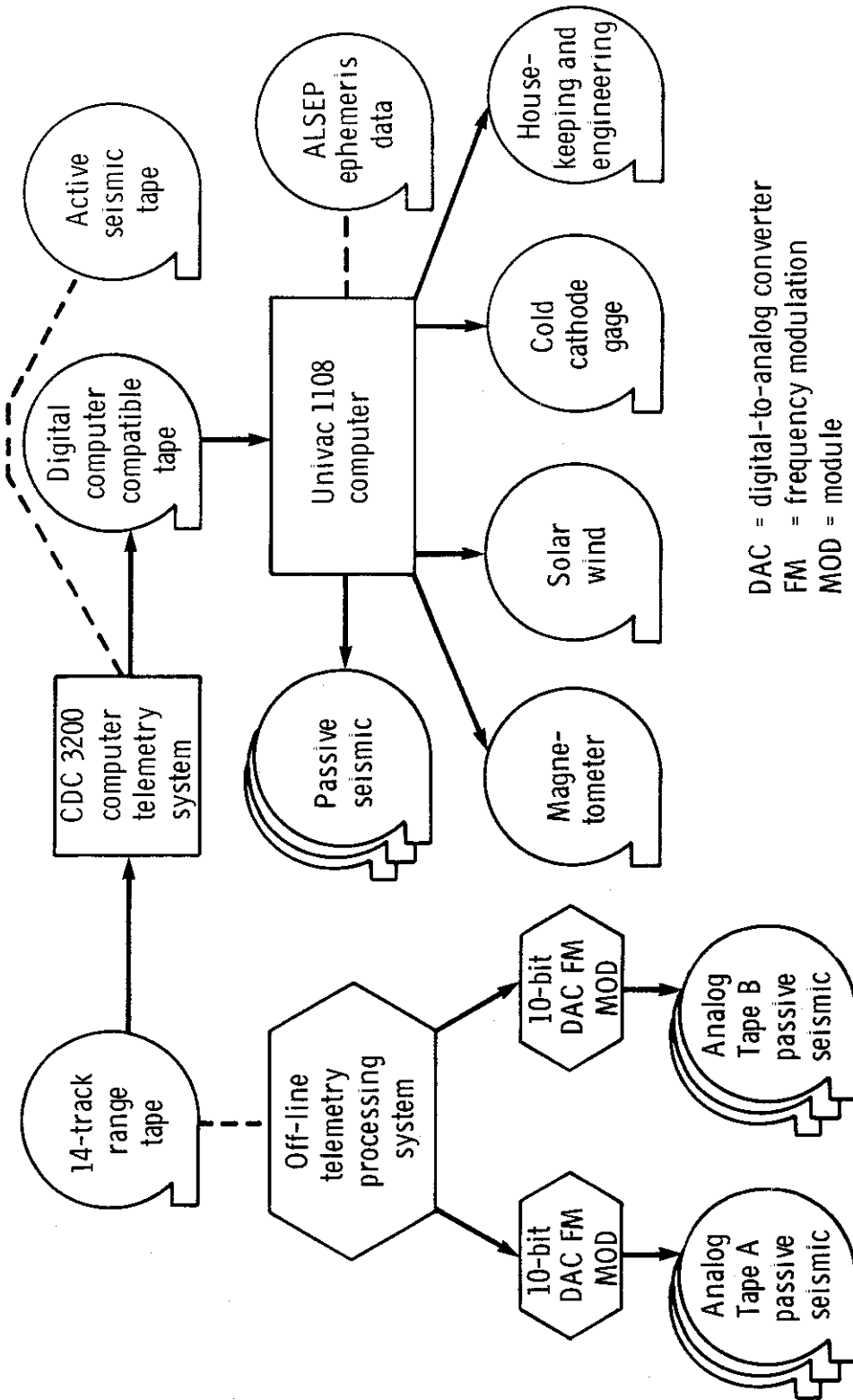
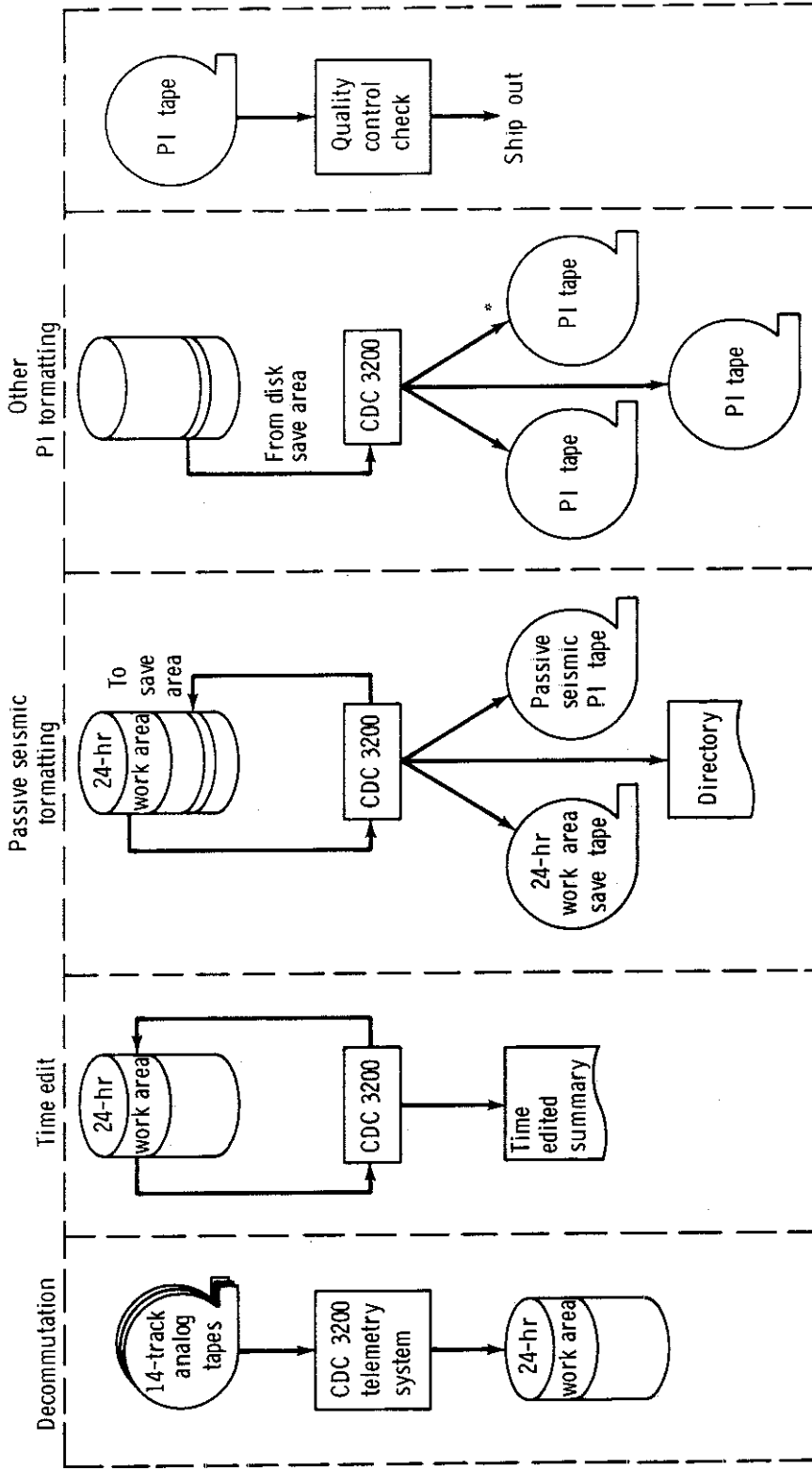
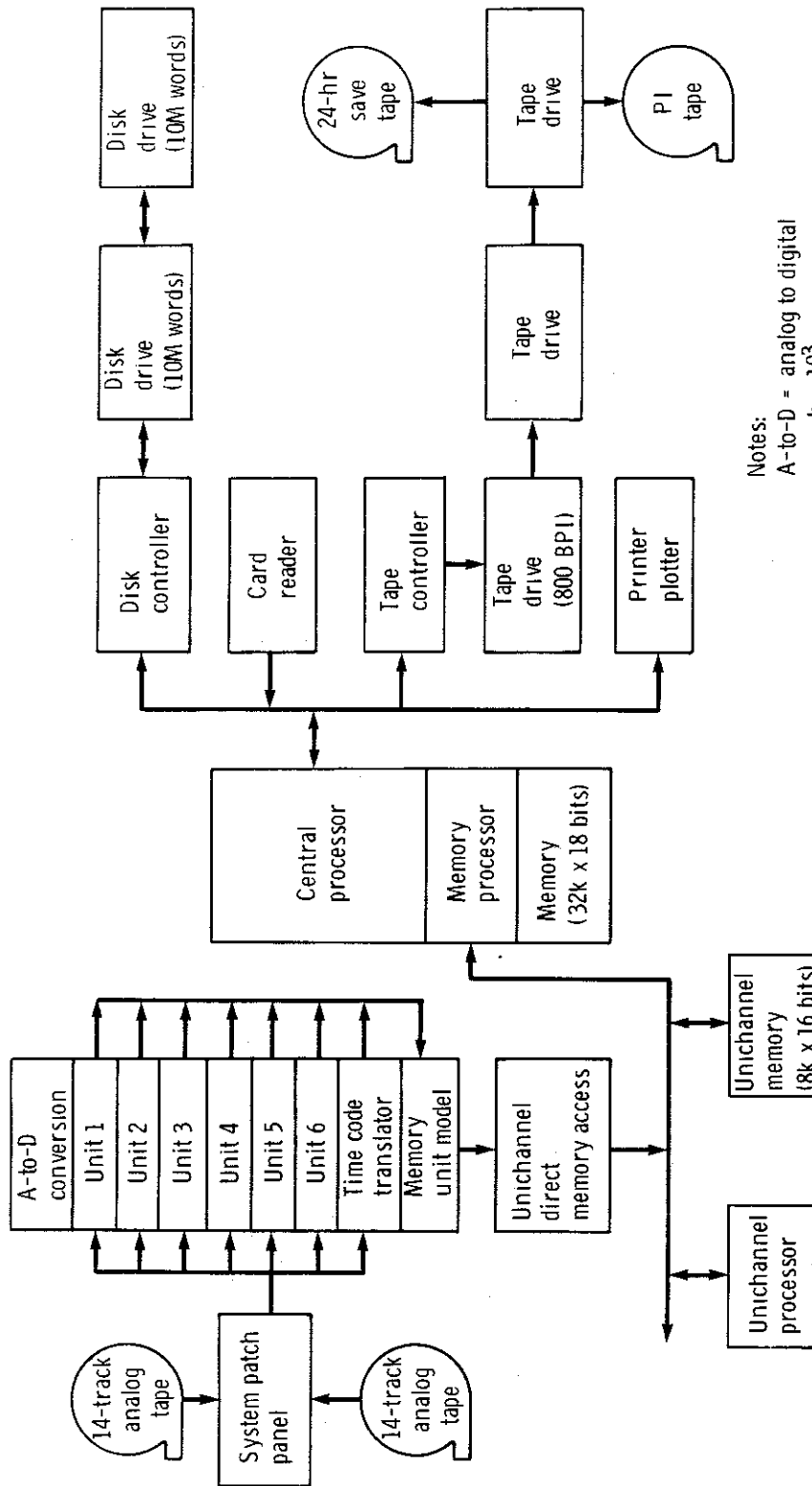

Figure 3-4.- ALSEP data processing flow through JSC Computation and Analysis Division.



*Limited to making a maximum of three PI tapes at one time

Figure 3-5.- Flow chart for modified ALSEP data processing (typical for one ALSEP).



Notes:
 A-to-D = analog to digital
 k = 10³
 M = 10⁶
 BPI = bits per inch

Figure 3-6.- Flow chart for ALSEP data processing at University of Texas.

ARCHIVING

Scientific analysis of ALSEP data was accomplished by NASA contracts with specific investigators, and these contracts stipulated the archiving of analyzed data. At the end of the Apollo Program, archiving received more attention, and JSC management believed that information obtained from the ALSEP stations should be in a form that approached as near as possible the "raw data" stage (range tapes) of the MSFN stations; i.e., with only noise removed and timing corrected.

To ensure proper data archiving, JSC management created the Geophysical Data Evaluation Working Group with representatives from the Massachusetts Institute of Technology, California Institute of Technology, University of California at Los Angeles, University of Texas at Dallas, University of Texas at Galveston, General Electric Co., NASA Ames Research Center, the JSC, the GSFC, NASA Headquarters, and the NSSDC.

The group was asked to study the data processing and make recommendations on the archiving and distribution most appropriate for the present and future needs of the scientific community. Critical decisions were needed concerning how, where, and in what form to store the data. Highlights of the study were as follows:

1. It would be neither practical nor desirable, in most cases, to distribute the raw data from the range tapes. Therefore, the group concluded that NASA should store, for use by other scientists, only data reduced and corrected by the PI. They believed the PI best understood the conditions under which the data were acquired and the pertinent details of the instrumentation.
2. The group concluded that some analyzed data should be stored because many studies could be made from such data without further processing.
3. The group agreed that microfilm of reduced data (in some cases only for special events) should be stored for dissemination, because this form was convenient for inspection by investigators.
4. Proper documentation was emphasized as an essential part of the archiving process. Without adequate documentation and supporting information (ephemeris, for example), the stored data would be of limited use.
5. Data from complementary experiments (e.g., Lunar Surface Magnetometer and Explorer 35 Magnetometer) should be stored together or cross referenced.

The study group surveyed the personnel, procedures, and facilities of the National Space Science Data Center (NSSDC) at GSFC. Alternatives, which they considered, included individual PI responsibility for storage and distribution of data and creation of a special Apollo data facility independent of NSSDC.

The final decision was that ALSEP data be collected and archived at the NSSDC in Greenbelt, Maryland.

NSSDC ARCHIVED DATA

The ALSEP data archived at the NSSDC are given in the following pages. The following information is given for each entry.

NSSDC ID number: This number is the NSSDC identification number to be used in requesting the material.

Description: This column provides a brief description or title of the data item and should be included with data requests. As presented here, the archived data are grouped by Apollo mission and subject of the experiment. The first entry in each group designates the Apollo mission and ALSEP experiment, and the subsequent entries designate other NSSDC data in this category.

Availability: Code letters in this column indicate the availability status as follows:

<u>Code:</u>	<u>Description:</u>
D	Data at NSSDC and being processed at this date (April 17, 1978).
H	Data that has been identified and which NSSDC intends to acquire but has not received at this date (April 17, 1978).
J	Proprietary data that can be distributed (April 17, 1978) only on the written request of the PI.

Time span: This column provides dates for the beginning and end of the designated data. Dates are given by month/day/year (e.g., 9/19/75).

Form: This column gives codes that identify the form of the data. The first letter indicates the basic form of the material, the second letter indicates the dimensions.

<u>First letter</u>	<u>Type</u>	<u>Units</u>
F	Microfiche (black and white)	Sheets
D	Digital magnetic tape	Reels
M	Microfilm	Reels

<u>Second letter</u>	<u>Description</u>
D	Original data tape
O	35-mm
P	16-mm
R	10 by 15 cm (4 by 6 inches)
T	Various sizes

Total quantity: This column gives the total quantity of the designated unit in the column "Form." Example: "Form: MP" and "Total quantity: 34" indicates 34 reels of 16-mm microfilm in that set of data.

ALSEP DATA AT NSSDC (April 17, 1978)

NSSDC ID number	Description	Avail-ability	Time span		Form	Total quantity
			First date	Last date		
71-008C-12A	Apollo 14, dust detector daytime data	D	05/05/71	02/24/76	MP	19
71-008C-12B	Dust detector eclipse data	D	01/30/72	01/30/72	MP	1
71-563C-09A	Apollo 15, dust detector daytime data	D	07/31/71	02/22/76	MP	19
69-059C-03A	Apollo 11, seismograph records, EASEP	D	07/21/69	08/11/69	MO	2
69-099C-03A	Apollo 12, passive seismic event tapes	D	11/20/69	02/22/75	DD	258
69-099C-03B	Compressed scale playouts	D	11/19/69	03/01/76	MT	8
69-099C-03C	Event tape compressed scale playout	D	11/20/69	10/05/75	MT	3
69-099C-03D	Expanded scale playouts	D	11/26/69	08/08/72	MO	2
69-099C-03E	Continuous data tapes	D	07/14/73	08/13/73	DD	30
69-099C-03F	Tapes of artificial impacts	D	11/20/69	08/03/70	DD	2
69-099C-03G	Event log as card images on tape	D	11/20/69	05/22/74	DD	1
69-099C-03H	Seismic event catalog	D	11/20/69	07/08/75	MO	1
69-099C-03I	Meteoroid impact event compressed scale	D	04/13/71	05/04/75	MP	1
69-099C-03J	Meteoroid impact expanded scale	D	04/13/71	05/04/75	MP	1
69-099C-03K	HF teleseismic event scale	D	04/13/71	05/04/75	MP	1
69-099C-03L	HF teleseismic compressed scale	D	04/13/71	05/04/75	MP	1
69-099C-03M	Moonquake event compressed scale	D	04/13/71	05/04/75	MP	1
69-099C-03N	Moonquake expanded scale	D	04/15/70	12/15/72	MP	1
69-099C-03O	Artificial impact expanded scale	D	04/13/71	05/27/75	MP	0
69-099C-03P	Artificial impact compressed scale	H	04/13/71	05/04/75	FR	1
69-099C-03Q	Selected seismic event catalog	D	04/13/71	05/04/75	DD	7
69-099C-03R	Large meteoroid impacts on tape	D	04/17/71	01/13/75	DD	2
69-099C-03S	High frequency teleseisms on tape	D	09/23/71	04/23/75	DD	2
69-099C-03T	Selected moonquake events on tape	D			DD	2

ALSEP DATA AT NSSDC (April 17, 1978)

NSSDC ID number	Description	Avail-ability	Time span		Form	Total quantity
			First date	Last date		
71-008C-04A	Apollo 14, passive seismic continuous data tapes	D	07/14/73	08/13/73	DD	30
71-008C-04B	Seismic event tapes	D	02/06/71	02/22/75	DD	228
71-008C-04C	Compressed scale playouts	D	02/05/71	03/01/76	MT	8
71-008C-04D	Expanded scale playouts	D	02/07/71	08/08/72	MO	2
71-008C-04E	Event tape compressed scale playout	D	02/06/71	10/05/75	MT	3
71-008C-04F	Tapes of artificial impacts	D	02/07/71	12/16/71	DD	1
71-008C-04G	Event log as card images on tape	D	02/07/71	05/22/74	DD	1
71-008C-04H	Seismic event catalog	D	02/07/71	07/09/75	MO	1
71-008C-04I	Meteoroid impact compressed scale	D	04/13/71	05/04/75	MP	1
71-008C-04J	Meteoroid impact expanded scale	D	04/13/71	05/04/75	MP	1
71-008C-04K	HF teleseismic event expanded scale	D	04/13/71	05/04/75	MP	1
71-008C-04L	HF teleseismic compressed scale	D	04/13/71	05/04/75	MP	1
71-008C-04M	Moonquake event compressed scale	D			MP	1
71-008C-04N	Moonquake expanded scale	D			MP	1
71-008C-04O	Artificial impact expanded scale	D	02/07/71	12/15/72	MP	1
71-008C-04P	Artificial impact compressed scale	H			MP	0
71-008C-04Q	Selected seismic event catalog	D	04/13/71	05/27/75	FR	1
71-008C-04R	Large meteoroid impacts, tape	D	04/13/71	11/21/74	DD	6
71-008C-04S	High frequency teleseisms, tape	D	04/17/71	01/13/75	DD	1
71-008C-04T	Selected moonquake events, tape	D	08/04/71	04/23/75	DD	2

ALSEP DATA AT NSSDC (April 17, 1978)

NSSDC ID number	Description	Avail-ability	Time span		Form	Total quantity
			First date	Last date		
71-063C-01A	Apollo 15, passive seismic continuous data tapes	D	07/13/73	08/13/73	DD	31
71-063C-01B	Seismic event tapes	D	08/02/71	02/12/75	DD	203
71-063C-01C	Expanded scale playouts	D	08/04/71	08/08/72	MO	2
71-063C-01D	Compressed scale playouts	D	09/02/71	03/01/76	MT	7
71-063C-01E	Tapes of artificial impacts	D	08/03/71	12/16/71	DD	1
71-063C-01F	Event tape compressed scale playback	D	08/01/71	10/04/75	MP	2
71-063C-01G	Event log as card images on tape	D	08/02/71	05/22/74	DD	1
71-063C-01H	Seismic event catalog	D	07/31/71	07/09/75	MO	1
71-063C-01I	Meteoroid impact event compressed	D			MP	1
71-063C-01J	Meteoroid impact expanded scale	D			MP	1
71-063C-01K	HF teleseismic event expanded	D			MP	1
71-063C-01L	HF teleseismic compressed scale	D			MP	1
71-063C-01M	Moonquake event compressed scale	D			MP	1
71-063C-01N	Moonquake expanded scale	D			MP	1
71-063C-01O	Artificial impact expanded scale	D	04/19/72	12/15/72	MP	1
71-063C-01P	Artificial impact compressed	H			MP	0
71-063C-01Q	Selected seismic event catalog	D	04/13/71	05/27/75	FR	1
71-063C-01R	Large meteoroid impacts, tape	D	10/20/71	11/21/74	DD	6
71-063C-01S	HF teleseismic events on tape	D	01/02/72	01/13/75	DD	1
71-063C-01T	Selected moonquake events on tape	D	08/04/71	04/23/75	DD	2

ALSEP DATA AT NSSDC (April 17, 1978)

NSSDC ID number	Description	Avail-ability	Time span		Form	Total quantity
			First date	Last date		
72-031C-01A	Apollo 16, passive seismic continuous data tapes	D	07/14/73	08/13/73	DD	29
72-031C-01B	Seismic event tapes	D	04/21/72	02/12/75	DD	163
72-031C-01C	Expanded scale playouts	D	04/21/72	08/08/72	MO	2
72-031C-01D	Compressed scale playouts	D	04/21/72	03/01/76	MT	7
72-031C-01E	Tapes of artificial impacts	D	12/10/72	12/15/72	DD	1
72-031C-01F	Event tape compressed scale playout	D	04/21/72	10/05/75	MP	2
72-031C-01G	Event log as card images on tape	D	04/21/72	05/22/74	DD	1
72-031C-01H	Seismic event catalog	D	04/22/72	07/09/75	MO	1
72-031C-01I	Meteoroid impact event, compressed	D			MP	1
72-031C-01J	Meteoroid impact, expanded scale	D			MP	1
72-031C-01K	HF teleseismic event expanded	D			MP	1
72-031C-01L	HF teleseismic compressed scale	D			MP	1
72-031C-01M	Moonquake event, compressed scale	D			MP	1
72-031C-01N	Moonquake, expanded scale	D			MP	1
72-031C-01O	Artificial impact, expanded scale	D	12/10/72	12/15/72	MP	1
72-031C-01P	Artificial impact, compressed scale	H			MP	0
72-031C-01Q	Selected seismic event catalog	D	04/13/71	05/27/75	FR	1
72-031C-01R	Large meteoroid impacts, tape	D	05/11/72	05/04/75	DD	5
72-031C-01S	High frequency teleseisms, tape	D	09/17/72	01/13/75	DD	1
72-031C-01T	Selected moonquake events, tape	D	05/27/72	04/23/75	DD	1

ALSEP DATA AT NSSDC (April 17, 1978)

NSSDC ID number	Description	Avail-ability	Time span		Form	Total quantity
			First date	Last date		
71-008C-05A	Apollo 14, active seismic event tapes	D	02/15/71	02/15/71	DD	1
72-031C-02A	Apollo 16, active seismic event tapes	D	04/21/72	05/23/72	DD	4
72-031C-02B	Active seismic event plots	D			MP	1
69-099C-04A	Apollo 12, lunar surface magnetometer, B magnitude, components, microfilm plots	D	11/19/69	04/03/70	MP	2
69-099C-04B	B magnitude, components, magnetic tape	D	11/19/69	04/03/70	DD	35
69-099C-04C	Sample decimated tape	D	11/28/69	12/03/69	DD	1
71-063C-03A	Apollo 15, lunar surface magnetometer, B magnitude, components, microfilm plots	D	07/31/71	09/20/72	MP	8
71-063C-03B	B magnitude, components, microfilm plots	D	07/31/71	09/20/72	DD	138
71-063C-03C	Sample decimated tape	D	07/31/71	08/15/71	DD	1
72-031C-03A	Apollo 16, lunar surface magnetometer, B magnitude, components, microfilm plots	D	04/21/72	03/03/75	MP	12
72-031C-03B	B magnitude, components, microfilm plots	D	04/27/72	02/14/73	DD	293
69-099C-02A	Apollo 12, solar wind spectrometer, plasma parameters, fine resolution on magnetic tape	D	11/19/69	01/29/73	DD	19
69-099C-02B	Hour-average plasma parameters on magnetic tape	D	11/19/69	12/31/74	DD	5
69-099C-02C	Hour-average plots, plasma parameters	D	11/20/69	12/31/74	MO	1

ALSEP DATA AT NSSDC (April 17, 1978)

NSSDC ID number	Description	Avail-ability	Time span		Form	Total quantity
			First date	Last date		
71-063C-04A	Apollo 15, solar wind spectrometer, plasma parameters, fine resolution, on magnetic tape	D	07/31/71	06/30/72	DD	3
71-063C-04B	Hour-average plasma parameters, on magnetic tape	D	07/31/71	12/08/71	DD	1
71-063C-04C	Hour-average plasma parameters, microfilm	D	08/02/71	06/30/72	MO	1
69-099C-05A	Apollo 12, suprathemal ion detector, suprathemal ion counts versus energy plots	D	09/14/71	08/28/74	MP	93
69-099C-05B	Suprathemal ion counts versus energy list	D	09/14/71	08/31/74	MP	274
69-099C-05C	Mass analyzer ion data on tape	D	11/19/69	03/03/73	DD	14
69-099C-05D	Engineering parameters for SIDE	D	08/17/72	09/18/74	MP	5
69-099C-05E	Ion spectrograms on film	D	11/19/69	01/25/73	MO	2
69-099C-05F	Total ion detector data on tape	D	11/19/69	03/14/73	DD	14
71-008C-06A	Apollo 14, suprathemal ion detector, plots of suprathemal ion counts versus energy	D	08/26/72	08/26/74	MP	168
71-008C-06B	Suprathemal ion counts versus energy list	D	08/26/72	08/26/74	MP	111
71-008C-06C	Mass analyzer data on tape	D	02/06/71	04/11/73	DD	14
71-008C-06D	Engineering parameters for SIDE	D	08/26/72	08/26/74	MP	4
71-008C-06E	Ion spectrograms on film	D	02/06/71	09/09/74	MO	3
71-008C-06F	Total ion detector data on tape	D	02/06/71	04/11/73	DD	14

ALSEP DATA AT NSSDC (April 17, 1978)

NSSDC ID number	Description	Avail-ability	Time span		Form	Total quantity
			First date	Last date		
71-063C-05A	Apollo 15, suprathemal ion detector, suprathemal ion counts versus energy plots	D	08/24/72	09/09/74	MP	278
71-063C-05B	Suprathemal ion counts versus energy list	D	08/26/72	09/09/74	MP	303
71-063C-05C	Mass analyzer data on tape	D	08/03/71	06/02/73	DD	10
71-063C-05D	Engineering parameters for SIDE	D	08/24/72	08/25/74	MP	8
71-063C-05E	Ion spectrograms on film	D	08/20/71	12/18/75	MO	2
71-063C-05F	Total ion detector data on tape	D	08/03/71	12/29/72	DD	12
71-063C-06A	Apollo 15, heat flow, thermal conductivity	D	07/31/71	12/28/74	DD	2
72-096C-01A	Apollo 17, heat flow, thermal conductivity	D	12/12/72	12/13/73	DD	2
72-096C-01B	Heat flow error analysis	D			MP	1
71-008C-08A	Apollo 14, charged particle experiment, count rate data on magnetic tape	D	02/05/71	03/02/73	DD	56
71-008C-08B	Experiment position and orientation information on tape	D	02/05/71	12/31/73	DD	1
71-008C-08C	200-EV electron count rates, microfilm	D	02/06/71	03/12/71	MO	1
69-099C-06A	Apollo 12, cold cathode ion, plots on film, lunar atmosphere pressure measurements	H			MO	0
69-099C-06B	Density plot per lunar day of neutral atmosphere	H			MO	0

ALSEP DATA AT NSSDC (April 17, 1978)

NSSDC ID number	Description	Avail-ability	Time span		Form	Total quantity
			First date	Last date		
71-008C-07A	Apollo 14, cold cathode ion gage, plots on film of lunar atmosphere pressure measurements	D	02/09/71	12/31/73	MO	3
71-008C-07B	Density plot per lunar day, neutral atmosphere	H			MO	0
71-063C-07A	Apollo 15, cold cathode ion gage, plots on film of lunar atmosphere pressure measurements	D	07/31/71	12/09/73	MO	3
71-063C-07B	Density plot per lunar day of neutral atmosphere	H			MO	0
72-096C-05A	Apollo 17, ejecta and meteorites event tapes	H			DD	0
72-096C-05B	Tabulation of all changes	H			MO	0
72-096C-06A	Apollo 17, seismic profiling tapes	J	12/14/72	12/17/74	DD	212
72-096C-06B	Seismic profiling active mode	D	12/14/72	12/18/72	DD	3
72-096C-07B	Apollo 17, surface electrical properties, demultiplexed data on tape	D	12/11/72	12/13/72	DD	1
72-096C-07C	Data plots on microfiche	D			FR	29
72-096C-08A	Apollo 17, Atmospheric composition, mass peak summary data on tape	D			DD	2
72-096C-08B	Tables of peaks, microfilm	D	01/02/73	10/04/73	MP	51
72-096C-08C	Mass peak data, tape	D	01/02/73	10/04/73	DD	10
72-096C-08D	Mass peak summary data, microfilm	D			MP	1

4. OPERATIONAL HISTORY

Scientific data-gathering equipment and related communications equipment were deployed on the lunar surface during each of the six Apollo lunar landing missions from July 21, 1969 (Apollo 11 mission), to December 12, 1972 (Apollo 17 mission). The performance of the deployed equipment, which was designed to provide data after the return of the crewmembers to Earth, is described in this section. Performance details include the following:

1. Time histories for each experiment are given up to September 30, 1977, when the ALSEP program was terminated.
2. Annotation of the time histories provides background information on significant events during the lifespan of each experiment.
3. A status summary (September 29, 1977) of Apollo Lunar Surface Experiments Package (ALSEP) performance is given in table 4-I at the end of this section.
4. Power output curves for the radioisotope thermoelectric generators (RTG's) are presented in figures 4-1 to 4-5 at the end of this section.

PASSIVE SEISMIC EXPERIMENT

Time history and proportion of full capability of instrument

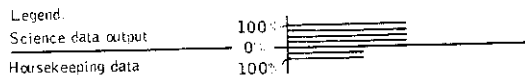
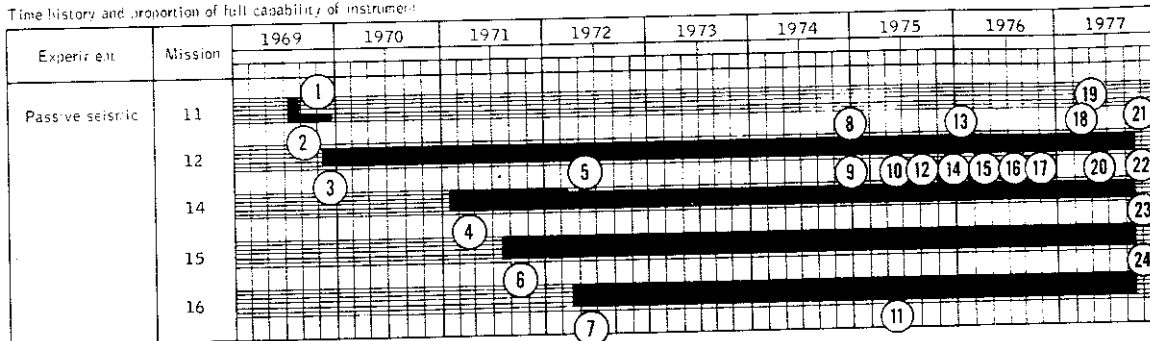

<u>Item</u>	<u>Apollo mission</u>	<u>Initial date of occurrence</u>	<u>Status</u>
1	11	Aug. 27, 1969	PSE STANDBY mode. Station 11 operated for 20 Earth days before loss of the ALSEP central station command uplink terminated seismometer functions such as leveling, gain adjustments, and calibration.
2	12	Nov. 19, 1969	SPZ component displaying reduced sensitivity at low signal levels. The other three seismometers (LPX, LPY, LPZ) have operated properly since initial activation.
3	12	Nov. 22, 1969	Thermal control problems. These thermal disturbances were most intense near sunrise and sunset. They are believed to be due to thermal contraction and expansion of the aluminized Mylar shroud that covers the sensor unit or to thermal contraction and expansion of the cable connecting the sensor unit to the central station, or both.
4	14	Feb. 12, 1971	Thermal control problems. The modified thermal shroud used on Apollo 14 provided improved thermal control. It was found that if the heater was commanded OFF for lunar day and AUTO for lunar night, the PSE temperature remained within the expected range for Apollo 14.

PASSIVE SEISMIC EXPERIMENT - Continued

<u>Item</u>	<u>Apollo mission</u>	<u>Initial date of occurrence</u>	<u>Status</u>
5	14	Mar. 20, 1972	LPZ axis inoperative. Analysis of the problem indicated this failure was either component failure or a wire connection problem. It was concluded that the failure was random rather than generic.
6	15	Aug. 13, 1971	Thermal control degradation. Review of lunar surface photographs showed that the periphery of the thermal shroud did not lie flat on the lunar surface. The incomplete deployment of the shroud resulted in excessive thermal leaks and loss of tidal data. For subsequent missions, crew training emphasized the need for the periphery of the shroud to be flat on the surface.
7	16	Apr. 24, 1972	High temperature during lunar day. Photographs of the deployed experiment, television coverage of the lunar module ascent, and comments by the crew indicated the following as possible causes of the problem: (1) some raised portions of the shroud, (2) dirt on the shroud from crew traffic subsequent to the photography, (3) debris from lift-off, and (4) possible contact of the experiment with the lunar surface. Any of the above conditions could cause degraded thermal control, resulting in higher temperatures during lunar day.
8	12	Oct. 16, 1974	The instrument was commanded to operate with the feedback filter IN. The principal investigator requested this operation to obtain data for comparison with data from filter OUT operation. The instrument performed satisfactorily with the feedback filter IN. Test was completed on Apr. 9, 1975, and the instrument was returned to the feedback filter OUT mode.

PASSIVE SEISMIC EXPERIMENT - Continued

<u>Item</u>	<u>Apollo mission</u>	<u>Initial date of occurrence</u>	<u>Status</u>
9	12	Nov. 7, 1974	An operational check on Nov. 7, 8, and 9, 1974, indicated that the heater could not be set in the auto OFF or forced OFF modes. Preliminary analysis indicated the cause of the failure to be that the heater ON/OFF relay driver circuit failed "closed" allowing +29 V dc power to be applied at all times.
10	14	Mar. 5, 1975	No command capability; therefore, no leveling possible. Engineering data from the PSE were valid. Science data from the PSE could be used for a period of approximately 9 days when the long period y-axis moved from off scale high to off scale low (Sun angles 55° to 109°) and off scale low to off scale high (Sun angles 185° to 237°). When Apollo 14 central station uplink capability was lost, the PSE heater was in the forced OFF mode for lunar daytime operation. The instrument remains in this configuration.
11	12, 15, and 16	June 28, 1975	Feedback filter IN. The instruments performed satisfactorily in this configuration.
12	14	Aug. 31, 1975 and Sept. 3, 1975	Although no leveling had been accomplished on the PSE since Mar. 1, 1975, because of the loss of command capability, a seismic event on these dates indicated that data were discernible on the long period x- and y-axis on the recorders.
13	12	Dec. 5, 1975	Noise spike appeared in seismic data as a result of the third bit not setting in the PSE electronics analog-to-digital converter. Increasing the central station heat eliminated the problem.

PASSIVE SEISMIC EXPERIMENT - Continued

<u>Item</u>	<u>Apollo mission</u>	<u>Initial date of occurrence</u>	<u>Status</u>
14	14	Feb. 19, 1976	With return of uplink, subsequent attempts to command the feedback filter IN have shown the loop to be inoperative. The instrument was performing satisfactorily with the filter out. The long period y-axis could not be leveled during the uplink capability period.
15	14	Mar. 17, 1976	When loss of downlink and uplink occurred with the Apollo 14 central station, the PSE was ON and the heater was in the forced OFF mode.
16	14	May 20, 1976	With return of downlink, the PSE was ON.
	14	May 24, 1976	Y-axis successfully leveled for first time since Mar. 1, 1975.
	14	May 27, 1976	Feedback loop filter OUT.
	14	June 8, 1976	Lost downlink.
	14	June 11, 1976	Acquisition of signal; instrument ON. Feedback filter OUT.
17	14	Sept. 18, 1976	Feedback filter IN.
	14	Oct. 9, 1976	Loss of signal with instrument configured to ON.
	14	Nov. 12, 1976	Acquisition of signal; instrument ON.
	14	Nov. 17, 1976	The long period z-axis responded to leveling; calibration and seismic events possible for first time since Mar. 1972. Feedback loop filter OUT.
18	12	Apr. 14, 1977	The long period z-axis seismic data are static.
19	12	Apr. 22, 1977	The long period z-axis seismic data returned to normal.
20	14	June 20, 1977	Long period z-axis data static.

PASSIVE SEISMIC EXPERIMENT - Concluded

<u>Item</u>	<u>Apollo mission</u>	<u>Initial date of occurrence</u>	<u>Status</u>
21	12	Sept. 30, 1977	Configured to STANDBY, could be commanded ON.
22	14	Sept. 30, 1977	Configured to STANDBY, could be commanded ON.
23	15	Sept. 30, 1977	Configured to OFF and should not be commanded ON.
24	16	Sept. 30, 1977	Configured to STANDBY, could be commanded ON.

ACTIVE SEISMIC EXPERIMENT

Time history and proportion of full capability of instrument

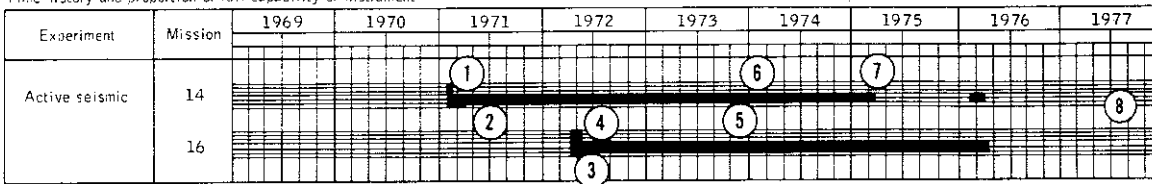

Legend:

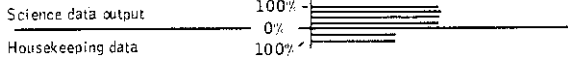

<u>Item</u>	<u>Apollo mission</u>	<u>Initial date of occurrence</u>	<u>Status</u>
1	14	Feb. 5, 1971	Thumper misfired 5 of 18 times. The problem was attributed to dirt on the firing switch actuator bearing surface. The situation was subsequently corrected for the Apollo 16 mission.
2	14	Mar. 26, 1971	Geophone 3 data were noisy because of transistor failure in amplifier 3. Data were recoverable to some extent by analysis.
3	16	May 23, 1972	Grenades 2, 4, and 3 were fired. Mortar package pitched down 90° as a result of launching grenade 2. The grenade 2 range wire probably fouled during launch, producing a downward force. Normal real-time event data were not received during flight of grenade 2. Grenade 1 was not fired at this time because of the failure of the pitch sensor of the mortar package after the grenade 4 firing. Internal temperatures of the mortar package vary from off scale low at night to 388.85 K (115.7° C) during lunar day, because some thermal protection was removed during the firing of the grenades.

ACTIVE SEISMIC EXPERIMENT - Concluded

<u>Item</u>	<u>Apollo mission</u>	<u>Initial date of occurrence</u>	<u>Status</u>
4	16	May 23, 1972	Pitch sensor off scale high after launching of grenade 3. Data imply there was a sensor circuit failure. Detonation of grenade 4 successfully accomplished. Grenade 1 was not fired because of the uncertainty of the mortar pallet position. Launching of grenade 1 may be attempted, as a final experiment, should Apollo 16 ALSEP termination be considered.
5	14 and 16	Dec. 7, 1973	Weekly 30-min passive listening periods terminated in accordance with Apollo 14 ALSEP, SMEAR 86 and Apollo 16 ALSEP, SMEAR 27. The instruments will remain in STANDBY and OFF, respectively, with periodic high-bit-rate checks to verify functional capability.
6	14	Jan. 3, 1974	During the monthly operation check of the experiment, the data from geophone 2 appeared to be invalid. On Jan. 9, 1974, another operational check was conducted to further investigate the problem. Two geophone calibrations were commanded. The data indicated a response to the commanded pulses, but the response was improper. Analysis implied a failure in the amplifier channel 2 circuitry. Operational checks after Jan. 9, 1974, confirmed status was unchanged.
7	14	Mar. 5, 1975	Because of the loss of uplink capability with Apollo 14 central station, the ASE can no longer be commanded and the grenades remain unfired. (Subsequent operational tests of the grenade firing circuit showed that it would be unable to fire the grenades.)
8	14 and 16	Sept. 30, 1977	No change in status when ALSEP program was terminated.

LUNAR SURFACE MAGNETOMETER

Time history and comparison of full capability of instrument

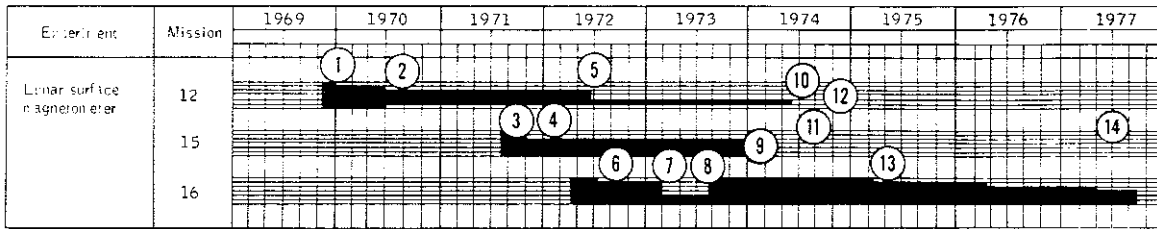

Legend:

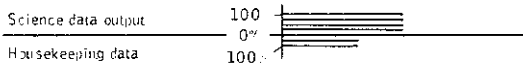

<u>Item</u>	<u>Apollo mission</u>	<u>Initial date of occurrence</u>	<u>Status</u>
1	12	Dec. 22, 1969	Y-axis data offset. A bias shift of approximately 75 percent occurred during lunar day when temperatures reached or exceeded 333 K (60° C). The data returned to normal as the temperature decreased to approximately 308 K (35° C). The failure was suspected to be due to a resistance change in the bias circuitry. It was probably caused by a partially open weld, a sensor connection, or a flexible cable. The bias command was used for compensating the data in real time.
2	12	June 29, 1970	Science and engineering data were static and invalid. It appeared that the static engineering data during the lunar night, the erratic flip calibration data, and no current to the y-axis flip motor were all caused by open welds in the circuitry. Reinspection by three independent teams, repairs as required, and the improvements in thermal control were implemented to alleviate the problem for subsequent missions.

LUNAR SURFACE MAGNETOMETER - Continued

<u>Item</u>	<u>Apollo mission</u>	<u>Initial date of occurrence</u>	<u>Status</u>
3	15	Aug. 30, 1971	Y-axis sensor head failed to flip on command. Normal calibration could not be provided because of the y-axis flip problem; a modified data processing program was written, using the solar-wind spectrometer data to fulfill the calibration requirements.
4	15	Nov. 2, 1971	Y-axis sensor data loss. To be useful, data from all three axes were required. Data output continued to be recorded and archived; it was hoped that a method to correlate and analyze the data would be developed at some future date.
5	12	June 14, 1972	Suspension of flip calibration sequences. Because of static data output from the instrument, the principal investigator requested that flip calibration sequences be terminated. Flip calibrations would be performed again if science data indicated the need.
6	16	July 24, 1972	Failure of all three axes to flip. Analysis of the data indicated the problem was due to an elevated temperature at lunar-noon conditions.
7	16	Feb. 15, 1973	Intermittent loss of science data. Over a period of several months, the output of the instrument varied from dynamic, valid data to a static condition. Attempts were made to correct the situation by ground command with no positive results obtained.
8	16	Aug. 17, 1973	Data processed by the principal investigator since Aug. 17, 1973, indicated that the instrument had returned to a fully operational condition. Return of the science data could not be fully explained at the time but could be partially attributed to prolonged "cold soak" periods during lunar night.

LUNAR SURFACE MAGNETOMETER - Continued

<u>Item</u>	<u>Apollo mission</u>	<u>Initial date of occurrence</u>	<u>Status</u>
9	15	Dec. 10, 1973	Loss of all scientific and engineering data. Attempts were made to correct the anomaly by ground command, but all data remained incoherent since initial date of the occurrence. The instrument remained in the power-on condition while investigation of the anomaly continued.
10	12	June 14, 1974	The instrument was permanently commanded OFF. The science and engineering data had been static and invalid since June 14, 1972. Output of the RTG had been steadily decreasing, and reserve power had become critical during lunar night to the point that a spurious functional change could have caused the loss of the currently functional instruments.
11	15	June 14, 1974	The instrument was permanently commanded OFF. The science and engineering data had been static and invalid since Dec. 10, 1973. Output of the RTG had been steadily decreasing, and reserve power had become critical during lunar night to the point that a spurious functional change could have caused the loss of the currently functional instruments.
12	12 and 15	July 2, 1974	The Apollo 12 instrument was commanded ON during real-time support on July 2, July 3, and Aug. 5, 1974. The Apollo 15 instrument was commanded ON during real-time support on July 2, 3, 5, and 29, 1974. The instruments did not downlink valid scientific and engineering data but the status bits were functioning properly in the inhibit, flip calibration and science and calibration modes. This indicated that operation was not degraded after two lunar nights in the OFF mode of operation. On Sept. 3, 1974, both instruments were commanded ON but drew only negligible power and did not return any valid scientific or engineering data.

LUNAR SURFACE MAGNETOMETER - Concluded

<u>Item</u>	<u>Apollo mission</u>	<u>Initial date of occurrence</u>	<u>Status</u>
			On Jan. 29, 1975, an inadvertent ground command to the Apollo 15 instrument turned it ON, resulting in a 6-W reserve power drain and no science or engineering data in the telemetry downlink. The instrument was commanded OFF, and the reserve power increased 6 W.
			On Dec. 18, 1975, an inadvertent ground command to the Apollo 15 instrument turned it ON. Later, the instrument was commanded OFF, and a minimal increase of 1 W in reserve power was observed.
13	16	Mar. 3, 1975	The z-axis-sensor science data had become intermittently static and the temperature had reduced to off scale low during the lunar night. Flip calibrations of the sensor heads have been discontinued, at the principal investigator's request, during the lunar night operation as a result of the low temperatures of the z-axis sensor.
14	12, 15 and 16	Sept. 30, 1977	No change in status when ALSEP program was terminated.

SOLAR-WIND SPECTROMETER

Time history and proportion of full capability of instrument

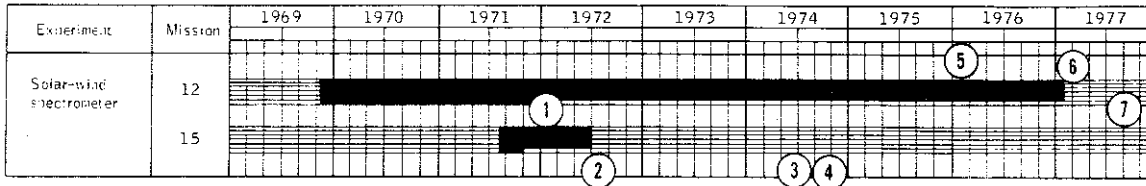

Legend:
 Science data output 100%
 0%
 Housekeeping data 100%

<u>Item</u>	<u>Apollo mission</u>	<u>Initial date of occurrence</u>	<u>Status</u>
1	12 and 15	Nov. 5, 1971	Intermittent modulation drop in proton energy levels 13 and 14. This thermally induced problem (which occurred each lunation) was attributed to a circuit that was used solely for ground test purposes.
2	15	June 30, 1972	Loss of experiment science and engineering data. Data analysis indicated high-voltage arcing was occurring in the equipment electronics causing excessive power consumption. The additional power consumption could not be tolerated by the Apollo 15 ALSEP system; therefore, the instrument was left in STANDBY mode indefinitely. The SWS was commanded to OPERATE SELECT periodically to ascertain any change in instrument status.
3	15	June 14, 1974	The instrument was permanently commanded OFF. The science and engineering data had been static and invalid since June 30, 1972. Output of the RTG had been steadily decreasing, and reserve power had become critical during lunar night to the point that a spurious functional change could have caused the loss of the currently functional instruments.

SOLAR-WIND SPECTROMETER - Concluded

<u>Item</u>	<u>Apollo mission</u>	<u>Initial date of occurrence</u>	<u>Status</u>
4	15	July 3, 1974	<p>The instrument was commanded ON during real-time support on July 3, July 29, and Sept. 3, 1974. No scientific or engineering data were received in the ALSEP downlink. Reserve power change was 6.00 W on July 29, but was negligible for the other checks.</p> <p>A spurious functional command to ON was received by the instrument on Jan. 25, 1975, resulting in a 3.9-W reserve power drain. The instrument was commanded to STANDBY (no reserve power change) and then to OFF, and the reserve power increased 3.9 W.</p> <p>A spurious functional command to STANDBY POWER ON was received by the instrument on Sept. 15, 1975, resulting in a 4-W reserve power drain. The decrease in reserve power was attributed to the standby heater turning on. The instrument was commanded to OFF and the reserve power increased 4 W.</p> <p>A spurious functional command to ON was received by the instrument on Jan. 31, 1976. The experiment was commanded to OFF by the Guam Tracking Station; an increase or decrease in reserve power was not observed.</p>
5	12	Mar. 3, 1976	<p>The instrument was being turned to STANDBY during the lunar night to provide more heat in the central station PSE electronics to avoid the PSE analog-to-digital converter anomaly.</p>
6	12	Jan. 15, 1977	<p>Instrument turned off to increase power available for central-station thermal control.</p>
7	12 and 15	Sept. 30, 1977	<p>No change in status when ALSEP program was terminated.</p>

SUPRATHERMAL ION DETECTOR

Time history and proportion of full capability of instrument

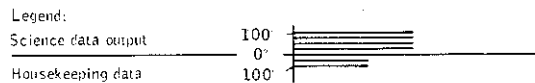
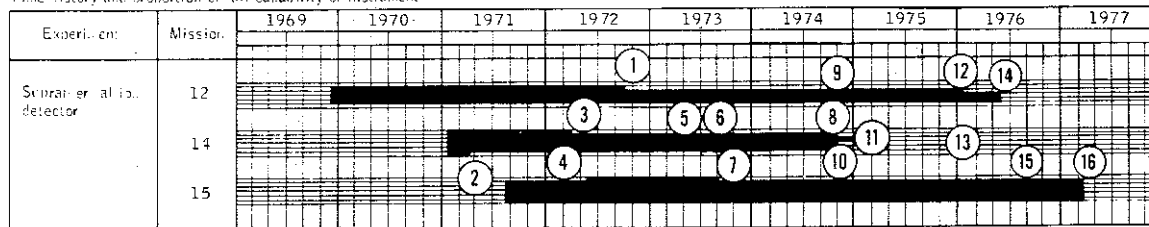

<u>Item</u>	<u>Apollo mission</u>	<u>Initial date of occurrence</u>	<u>Status</u>
1	12	Sept. 9, 1972	Intermittent failure of digital electronics to process data. High-voltage arcing occurred at elevated lunar-day temperatures. The instrument was being commanded to OFF when the internal temperature approached 328 K (55° C).
2	14	Apr. 5, 1971	Loss of the positive-section data of the analog-to-digital converter. The cause appeared to be an intermittent connection in one of the modules of the analog-to-digital converter and did not appear to be temperature dependent. Anomaly precluded processing of any positive-value data inputs to the analog-to-digital converter.
3	14	Mar. 29, 1972	Anomalous STANDBY operation of SIDE. The mode change problem was attributed to arcing or corona in the high-voltage supply at elevated temperatures. The experiment was commanded to STANDBY when the internal temperature approached 358 K (85° C) to preclude spurious mode changes.

SUPRATHERMAL ION DETECTOR - Continued

<u>Item</u>	<u>Apollo mission</u>	<u>Initial date of occurrence</u>	<u>Status</u>
4	15	May 1, 1972	Full instrument operation instituted. Prior to Oct. 20, 1972, the Apollo 15 SIDE was cycled to STANDBY during lunar day because of previous problems with the Apollo 12 SIDE. Based on data accumulated since deployment, it was decided to leave the instrument ON for the complete lunation.
5	14	Apr. 14, 1973	Anomalous STANDBY operation of SIDE. Subsequent to Apr. 1973, the instrument had gone from OPERATE to STANDBY without ground command at (or shortly after) the sunrise terminator crossing. The suspected cause was circuit breaker action in response to a SIDE current in excess of that required to trip the breaker. Data were obtained during lunar night when the instrument was ON. The instrument was permitted to switch itself from ON to STANDBY at sunrise terminator without commanding.
6	14	Aug. 8, 1973	There was no indication of STANDBY power ON or operating power OFF through the console monitor lights or the high-speed printer data. Analysis indicated that the fuse opened in the STANDBY power line; thus, STANDBY operation was now equivalent to OFF.
7	15	Sept. 13, 1973	Cyclic commanding required to preclude spurious mode changes above 358° K (85° C). Internal high-voltage arcing caused -3.5-kV power supply to trip OFF. The instrument was cycled to STANDBY during lunar day to preclude arcing.

SUPRATHERMAL ION DETECTOR - Continued

<u>Item</u>	<u>Apollo mission</u>	<u>Initial date of occurrence</u>	<u>Status</u>
8	12	Sept. 3, 1974	A reduction of high energy calibration and data counts occurred. Normal calibration and energy counts returned on Sept. 4, 1974. A reoccurrence of the anomaly was noted on Nov. 11, 1974. All engineering and science data during lunar night have been normal since Nov. 13, 1974. The suspected cause was a loss of amplifier gain for short periods.
9	12	Nov. 26, 1974	The instrument received a spurious functional command to ON during the lunar day. On Nov. 27, 1974, the experiment was checked; all high voltages were OFF and the electronics temperature (T2) was reading 349.95 K (76.8° C). The instrument was commanded OFF for cooling below the maximum operating temperature of 328 K (55° C). Normal and valid engineering and science data have been obtained in subsequent operations.
10	14	Nov. 29, 1974	The instrument could only be commanded ON briefly because of the lunar eclipse, although 72 commands were executed. Sporadic operation of the instrument was obtained during the next lunar night (Dec. 8 to 22, 1974) and none during the Jan. 6 to 21 and Feb. 5 to 20, 1975, lunar nights. More than 1700 unsuccessful ON commands have been transmitted to the instrument since the Nov. 29 lunar eclipse.
11	14	Jan. 5, 1975	Commanded OFF because of possible short circuit in high voltage supply.
12	12	Jan. 18, 1976	The instrument was being commanded to STANDBY during the lunar night to provide more heat in the central station PSE electronics to avoid the PSE analog-to-digital-converter anomaly.

SUPRATHERMAL ION DETECTOR - Concluded

<u>Item</u>	<u>Apollo mission</u>	<u>Initial date of occurrence</u>	<u>Status</u>
13	14	Feb. 19, 1976	With the return of uplink to the Apollo 14 central station, the experiment status was unknown. Experiment was commanded OFF as extra protection from possible high voltage short.
14	12	May 3, 1976	Commanded OFF.
15	15	Aug. 26, 1976	Operating in the RESET SIDE mode; frame counter at 39; 3.5-kV Channeltron in HIGH VOLTAGE.
16	15	Mar. 12, 1977	Commanded OFF.

HEAT FLOW EXPERIMENT

Time history and proportion of full capability of instrument

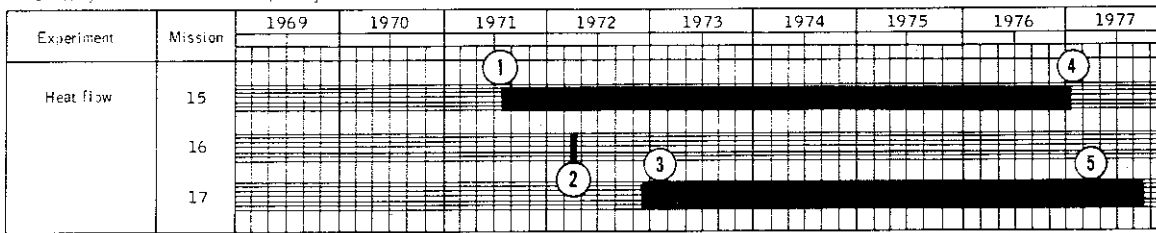

Legend.
 Science data output 100%
 0%
 Housekeeping data 100%

<u>Item</u>	<u>Apollo mission</u>	<u>Initial date of occurrence</u>	<u>Status</u>
1	15	July 31, 1971	Probe 2 was not inserted to full depth because of problems with the Apollo lunar surface drill. Probe 2 still provided useful data to estimate heat flow in the lunar subsurface. Drill bore stems were redesigned for Apollo 16 and 17 missions.
2	16	Apr. 21, 1972	Electrical cable was inadvertently severed during initial deployment by crew. Contingency repair plan proposed was denied because of higher mission priorities. Cable strain-relief provisions were implemented on all cables for the Apollo 17 mission.
3	17	N/A	Nominal deployment and full experiment operation.
4	15	Jan. 15, 1977	Commanded OFF. Had operated intermittently since Apr. 28, 1976, and data had been anomalous since Dec. 1975.
5	17	Feb. 18, 1977	Anomaly occurred in probe 2 at the 230-cm level.

CHARGED PARTICLE LUNAR ENVIRONMENT EXPERIMENT

Time history and proportion of full capability of instrument

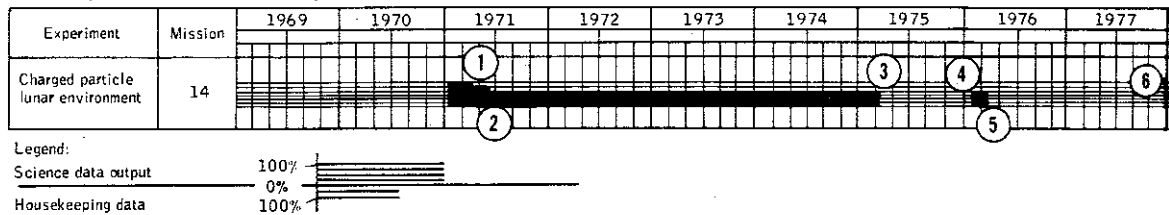

<u>Item</u>	<u>Apollo mission</u>	<u>Initial date of occurrence</u>	<u>Status</u>
1	14	Apr. 8, 1971	Loss of analyzer B data. Analysis indicated that the most probable cause of failure was a short in the high-voltage filter. The instrument continued operation on analyzer A. (Analyzer A provided identical data.)
2	14	June 6, 1971	Analyzer A data decay and undervoltage condition. The problem appeared to be caused by the analyzer B anomaly. Further analysis of the anomaly was impossible because the analyzers were not separable by command. Instrument was operated satisfactorily in a locked low-voltage range (-35 V dc) and was commanded to STANDBY when high voltage decayed below 2280 V dc. This operational mode resulted in operation for approximately 50 percent of each lunation.
3	14	Mar. 5, 1975	When the Apollo 14 central-station up-link capability was lost, the experiment was in STANDBY for lunar daytime operation. The instrument remained in this configuration.
4	14	Feb. 19, 1976	When the Apollo 14 central-station up-link and downlink capability was regained, the experiment was ON. Operation of the instrument was as specified in item 2.

CHARGED PARTICLE LUNAR ENVIRONMENT EXPERIMENT - Concluded

<u>Item</u>	<u>Apollo mission</u>	<u>Initial date of occurrence</u>	<u>Status</u>
5	14	Mar. 17, 1976	When the Apollo 14 central-station up-link and downlink capability was lost, the experiment was in STANDBY for lunar daytime operation. The instrument remained in this configuration. (NOTE: Operation of the CPLEE until ALSEP termination was related to the Apollo 14 central station anomaly. The subsection entitled "Central Station Electronics" gives the CPLEE configuration each time that the signal was lost and regained.)
6	14	Sept. 30, 1977	At the end of termination test, instrument was configured to STANDBY.

COLD CATHODE ION GAGE

Time history and proportion of full capability of instrument

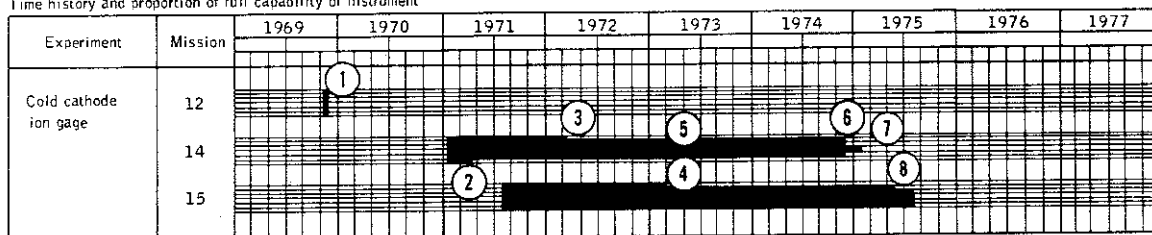

Legend:
 Science data output 100%
 0%
 Housekeeping data 100%

<u>Item</u>	<u>Apollo mission</u>	<u>Initial date of occurrence</u>	<u>Status</u>
1	12	Nov. 20, 1969	CCIG failure, high-voltage arcing problems. Ground tests verified that a transistor failed in high-voltage control circuit. A slower response transistor operated satisfactorily in the environment with reasonable margins. Appropriate modifications were made to Apollo 14 SIDE/CCIG.
2	14	Apr. 5, 1971	Loss of the positive-section data of the analog-to-digital converter. The cause appeared to be an intermittent connection in one of the modules of the analog-to-digital converter and did not appear to be temperature dependent. This anomaly precluded processing of any positive-value data inputs to the analog-to-digital converter.
3	14	Mar. 29, 1972	Anomalous STANDBY operation of SIDE. The mode change problem was attributed to arcing or corona in the high-voltage supply at elevated temperatures. The experiment was now commanded to STANDBY when the internal temperature approached 358 K (85° C) to preclude spurious mode changes.

COLD CATHODE ION GAGE - Concluded

<u>Item</u>	<u>Apollo mission</u>	<u>Initial date of occurrence</u>	<u>Status</u>
4	15	Feb. 22, 1973	Intermittent science data. Preliminary analysis indicated that the most probable cause was one of the 15 relays. These reed relays performed functions that controlled the CCIG calibration currents, the ranging and gain change functions, and grounding the instrument during calibration. At this time, no plans existed for continued investigation of the anomaly, because the scientific data were usable when obtained.
5	14	Apr. 8, 1973	See item 6 of the status report on the Suprathermal Ion Detector Experiment.
6	14	Nov. 29, 1974	See item 11 of the status report on the Suprathermal Ion Detector Experiment.
7	14	Jan. 5, 1975	Commanded OFF.
8	15	July 18, 1975	CCIG failure; high voltage was off and could not be commanded ON.

LASER RANGING RETROREFLECTOR

Time history and proportion of full capability of instrument

Experiment	Mission	Time History (1969-1977)															
		1969	1970	1971	1972	1973	1974	1975	1976	1977	1969			1970			1971
Laser ranging retroreflector	11	[Solid black bar]															
	14	[Solid black bar]															
	15	[Solid black bar]															

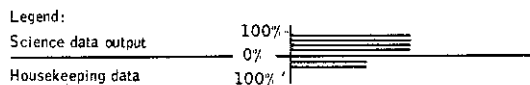

<u>Item</u>	<u>Apollo mission</u>	<u>Initial date of occurrence</u>	<u>Status</u>
1	11 and 14	N/A	Performance of both 100-element arrays (Apollo 11 and 14) was nominal since their initial deployment.
2	15	July 31, 1971	Data from the 300-element array indicated that its performance was comparable, but not superior, to the 100-element arrays.

LUNAR EJECTA AND METEORITES EXPERIMENT

Time history and proportion of full capability of instrument

Experiment	Mission	Year									
		1969	1970	1971	1972	1973	1974	1975	1976	1977	
Lunar ejecta and meteorites	17										

Legend:

Science data output	100%	
	0%	
Housekeeping data	100%	

<u>Item</u>	<u>Apollo mission</u>	<u>Initial date of occurrence</u>	<u>Status</u>
1	17	Dec. 17, 1972	Excessive temperature. The experiment experienced a higher temperature profile than expected because of an error in calculation of thermal control and because of a difference in thermal conditions at the Apollo 17 site compared with the design site. The instrument was operated at temperatures below 364 K (196° F). This operational plan resulted in the monitoring of about 75 percent of each lunation.
2	17	July 16, 1976	At PI request, instrument was operated through lunar noon; survival temperature reached 373 K (212° F). On July 16, 1976, the data became static and did not recover.

LUNAR SEISMIC PROFILING EXPERIMENT

Time history and proportion of full capability of instrument

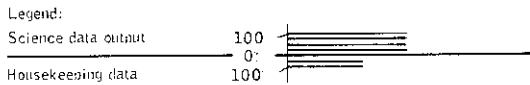
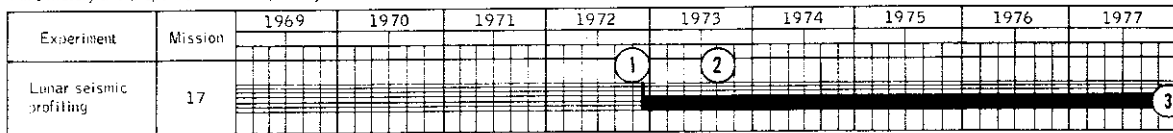

<u>Item</u>	<u>Apollo mission</u>	<u>Initial date of occurrence</u>	<u>Status</u>
1	17	N/A	Initial scientific objective was accomplished with detonation of eight explosive packages. The instrument was commanded ON weekly for a 30-min passive listening period. (Note: Operation of the LSPE precluded data from the other four experiments, because of high-bit-rate formatting; therefore, LSPE operation was time limited.)
2	17	July 13, 1973	To pursue a study of meteoroid impacts and thermal moonquakes, passive listening periods were scheduled to acquire a "listening mode" data record covering one full lunation. The first extended listening period began on July 13, 1973, and was terminated on July 17, 1973 (Sun angles of 100.4° to 147.8°). Subsequent listening periods were completed on Mar. 3 to 7, 1974 (Sun angles of 59.5° to 102.2°), Aug. 12 to 16, 1974 (Sun angles of 233.7° to 285.6°), Sept. 6 to 10, 1974 (Sun angles of 181.4° to 235.1°), Oct. 22 to 25, 1974 (Sun angles of 22.5° to 60.2°), Nov. 1 to 5, 1974 (Sun angles of 145° to 193.9°), Dec. 12 to 16, 1974 (Sun angles of 283.7° to 333.0°), and Apr. 13 to 18, 1975 (Sun angles of 327.6° to 28.7°), which completed one 360° lunation. Three additional periods, sunrise (Sun angles of 327.6° to 28.7°) and sunset terminators (Sun angles of 126.6° to 180.3°), and eclipse (May 25), were obtained at special request.
3	17	Sept. 30, 1977	No change in status when ALSEP program was terminated.

LUNAR ATMOSPHERIC COMPOSITION EXPERIMENT

Time scale is proportion of full capability of instrument.

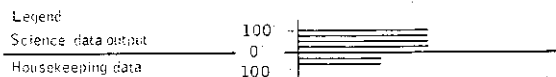
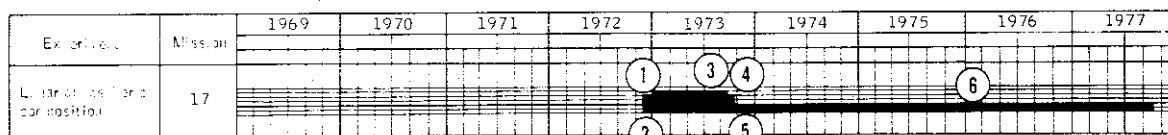

<u>Item</u>	<u>Apollo mission</u>	<u>Initial date of occurrence</u>	<u>Status</u>
1	17	Dec. 17, 1972	Excessive temperature with cover on. An error in thermal design and temperature-sensitive components limited the experiment operation to temperatures below 325 K (125° F). This situation precluded instrument operation during elevated lunar-day temperatures.
2	17	Dec. 18, 1972	Zero offset in data output of mass channels; cause of this background offset remains undetermined. The data were usable with additional processing during data reduction.
3	17	Sept. 18, 1973	Loss of intermediate-mass-range output caused loss of approximately 12 percent of the experiment data. Subsequent multiple failures of the instrument precluded further analysis of the problem.
4	17	Sept. 23, 1973	Filament 1 failure. The filament accumulated approximately 3000 hr of operation before failure. This was well within the predicted range for operating life. The instrument was reconfigured to the redundant filament.

LUNAR ATMOSPHERIC COMPOSITION EXPERIMENT - Continued

<u>Item</u>	<u>Apollo mission</u>	<u>Initial date of occurrence</u>	<u>Status</u>
5	17	Oct. 17, 1973	Loss of science data. Preliminary results of trouble-shooting and analysis indicated that the multiplier high-voltage power supply apparently failed. At that time, the instrument was being cycled from ON to OFF to maintain the electronics temperature below the previously established 325 K (125° F) limit, while future trouble-shooting or termination of instrument operation was considered.
6	17	Jan. 18, 1974 to Feb. 26, 1976	A total of nine operational checks were performed, following both "bakeout" and "cold soak," in attempts to regain the proper voltage, but each attempt was unsuccessful.

LUNAR SURFACE GRAVIMETER

Time history and proportion of full capability of instrument

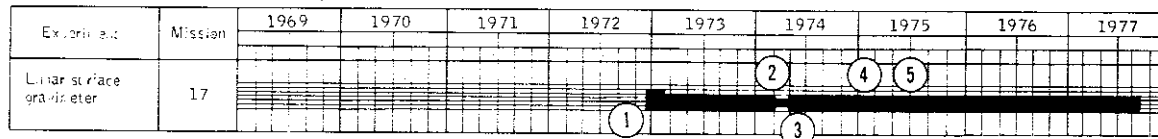

Legend.

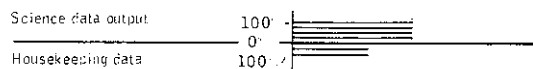

<u>Item</u>	<u>Apollo mission</u>	<u>Initial date of occurrence</u>	<u>Status</u>
1	17	Dec. 12, 1972	Sensor beam could not be stabilized in the null position because 1/6-g mass weights were too light. Weights were light because of a manufacturer's error in calculations converting from 1-g to 1/6-g requirements. Several reconfigurations of the instrument were made during the previous year. The beam was centered by applying a load on the beam through the mass support springs by partial caging of the mass weight assembly. Signals received were processed and analyzed for seismic, free mode, and gravity wave information.
2	17	Mar. 15, 1974	The heater box heater circuit failed full ON during the 16th lunar night. This anomaly caused the sensor temperature (DG-04) to increase above a stabilized temperature of 322.337 K (49.207° C) and eventually drift off scale high. Transducer range was approximately 321.33 to 325.13 K (48.2° to 52.0° C). Useful science data could not be obtained from the instrument unless the sensor assembly temperature was maintained rigorously at 322.3 K (49.2° C). (The anomaly reoccurred on July 7, 1975, and on Sept. 19, 1975.)

LUNAR SURFACE GRAVIMETER - Concluded

<u>Item</u>	<u>Apollo mission</u>	<u>Initial date of occurrence</u>	<u>Status</u>
3	17	Apr. 20, 1974	The LSG regained thermal stability. The experiment sensor temperature had remained stabilized at 322.4 K (49.2° C) since Apr. 20, 1974. On Sept. 2, 1975, the thermal stability returned, and the temperature stabilized at 324.65 K (51.5° C). Since Sept. 19, 1975, attempts to regain control have been unsuccessful.
4	17	Jan. 7, 1975	The sensor beam was repositioned to near center (0.0030 V dc) in the "seismic gain low" mode by using the north/south and east/west tilt servomotors.
5	17	July 30, 1975	An intermittent operation of the analog-to-digital converter occurred during the periods when the temperature was off scale high. The analog-to-digital converter operated normally when the temperature was reduced, and it operated normally when thermal stabilization was regained. Normal operation was accomplished by manually commanding the heater ON/OFF to maintain the temperature within the transducer range (321.35 to 325.15 K (48.2° to 52.0° C)) as closely as possible.

DUST DETECTOR EXPERIMENT

Time history and proportion of full capability of instrument

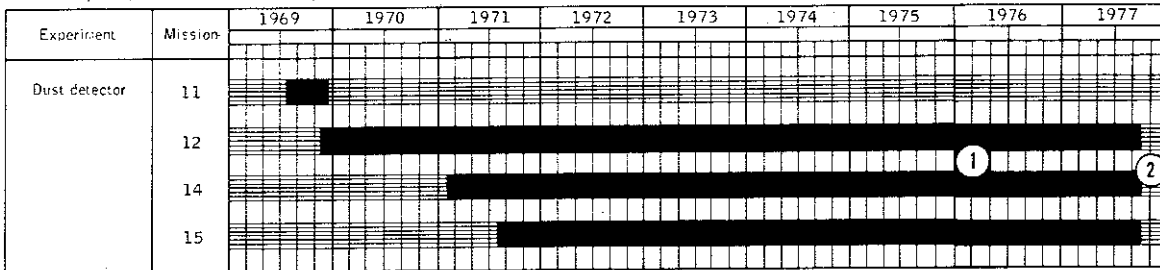

Legend:

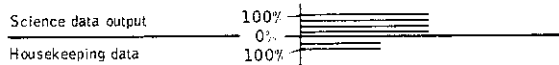

<u>Item</u>	<u>Apollo mission</u>	<u>Initial date of occurrence</u>	<u>Status</u>
1	14	Mar. 1, 1975 to Aug. 7, 1977	For the Apollo 14 central station, there was loss of signal (LOS) and acquisition of signal (AOS) for a total of six times. At LOS and AOS, the dust detector was always configured to ON, except Nov. 12, 1976.
2	12, 14 and 15	Sept. 30, 1977	Configured to OFF when ALSEP operations were terminated. Performance of the equipment was nominal.

CENTRAL STATION ELECTRONICS

Time history and proportion of full capability of instrument

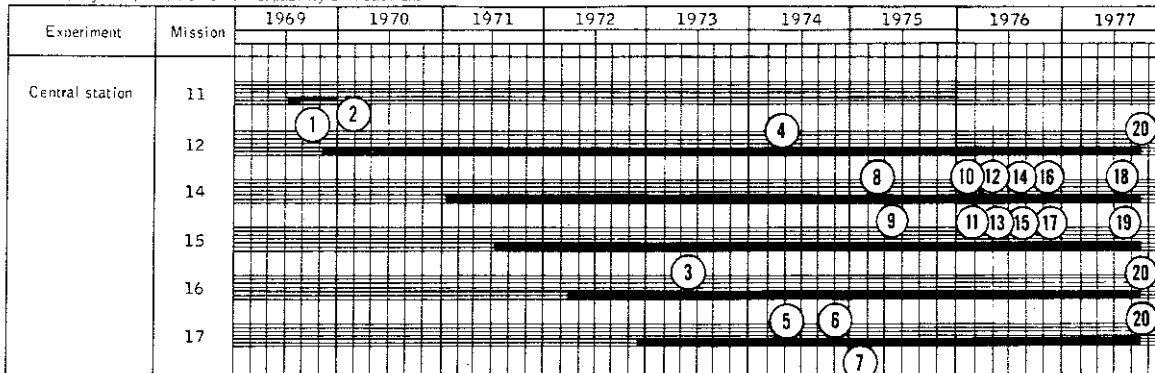

Note: All central station data are considered housekeeping rather than science data

Legend:

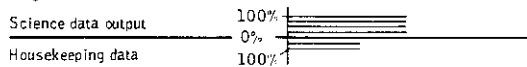

<u>Item</u>	<u>Apollo mission</u>	<u>Initial date of occurrence</u>	<u>Status</u>
1	11	Aug. 25, 1969	Loss of command capability. The inability to command the EASEP central station was attributed to a component failure in the central station command decoder. The failure mode was considered unique to Apollo 11 EASEP because subsequent ALSEP units maintained a benign thermal environment by comparison. The command system had already exceeded the mission requirements.
2	11	Dec. 14, 1969	Loss of downlink. The Apollo 11 EASEP apparently responded to a transmitter OFF command or incurred an additional failure. In either case, the system had exceeded its initial mission requirement. NASA subsequently directed that no further attempts be made to command the system ON; thus, the frequency could be used for future ALSEP systems.

CENTRAL STATION ELECTRONICS - Continued

<u>Item</u>	<u>Apollo mission</u>	<u>Initial date of occurrence</u>	<u>Status</u>
3	16	Mar. 26, 1973	Transmitter B and processor Y were selected by ground command. The Ascension ground station had been experiencing poor data quality; however, DECOM LOCK could be maintained with transmitter A. Data quality improved and a gain in signal strength of 2 dBm was noted when transmitter B was selected. Analysis did not identify a specific cause, and transmitter A could still be used if necessary.
4	12	May 3, 1974	Loss of downlink signal modulation. Apparent failure of data processor Y. Operation of data processor X, transmitter A, and transmitter B appeared normal. Central station functioned normally with transmitter B and data processor X selected.
5	17	Aug. 16, 1974	Intermittent command capability. Frequent attempts to execute certain commands (octals 070, 170, and 174) were unsuccessful using uplink A. Uplink B was selected on Aug. 19. Subsequent to selection of uplink B, system response to commands had been nominal.
6	17	Oct. 14, 1974	Intermittent DECOM LOCK. While operating with transmitter A and a received signal strength of -146 dBm, the Bermuda tracking station noted poor quality telemetry data and incurred difficulty in maintaining DECOM LOCK. Transmitter A was commanded OFF at 14:21 UT and transmitter B commanded ON at 14:22 UT. A gain of 2 dBm was noted in telemetry signal strength. Subsequent operations with transmitter B have been nominal.

CENTRAL STATION ELECTRONICS - Continued

<u>Item</u>	<u>Apollo mission</u>	<u>Initial date of occurrence</u>	<u>Status</u>																										
7	17	Dec. 6, 1974	Intermittent DECOM LOCK. On Dec. 6, 1974, while operating with transmitter B and a received signal strength of -146.0 to -148.5 dBm, the Ascension and Canary Islands tracking stations reported sporadic data dropouts and poor quality telemetry data. Transmitter B was commanded OFF at 15:31 UT and transmitter A commanded ON at 15:32 UT, Dec. 9, 1974. A gain of 2 dBm was noted in telemetry signal strength by the Hawaii tracking station. Subsequent operations have been satisfactory with transmitter A.																										
8	14	Mar. 1, 1975	Loss of signal occurred at 00:08 UT, Mar. 1, 1975. Playback of data before loss of signal showed normal values for all housekeeping parameters. Commands transmitted to the station to turn the transmitters ON were unsuccessful. At loss of signal, the configuration status was as follows: <table border="0" style="margin-left: 40px;"> <tr> <td>Sun angle</td> <td>108.10</td> </tr> <tr> <td>Avg therm pl</td> <td>319.96 K (115.80 F)</td> </tr> <tr> <td>RTG power</td> <td>63.63 W</td> </tr> <tr> <td>Res power</td> <td>39.11 W</td> </tr> <tr> <td>Transmitter</td> <td>A</td> </tr> <tr> <td>Receiver</td> <td>ON-Xtal A</td> </tr> <tr> <td>PCU</td> <td>1</td> </tr> <tr> <td>PSE</td> <td>ON</td> </tr> <tr> <td>PSE Htr</td> <td>Forced OFF</td> </tr> <tr> <td>CPLLE</td> <td>STBY</td> </tr> <tr> <td>SIDE</td> <td>UNK</td> </tr> <tr> <td>ASE</td> <td>STBY</td> </tr> <tr> <td>DTREM</td> <td>ON</td> </tr> </table>	Sun angle	108.10	Avg therm pl	319.96 K (115.80 F)	RTG power	63.63 W	Res power	39.11 W	Transmitter	A	Receiver	ON-Xtal A	PCU	1	PSE	ON	PSE Htr	Forced OFF	CPLLE	STBY	SIDE	UNK	ASE	STBY	DTREM	ON
Sun angle	108.10																												
Avg therm pl	319.96 K (115.80 F)																												
RTG power	63.63 W																												
Res power	39.11 W																												
Transmitter	A																												
Receiver	ON-Xtal A																												
PCU	1																												
PSE	ON																												
PSE Htr	Forced OFF																												
CPLLE	STBY																												
SIDE	UNK																												
ASE	STBY																												
DTREM	ON																												

(Avg therm pl = average thermal plate temperatures; Res = reserve; Xtal = crystal; PCU = power conditioning unit; Htr = heater; STBY = standby; UNK = unknown)

CENTRAL STATION ELECTRONICS - Continued

<u>Item</u>	<u>Apollo mission</u>	<u>Initial date of occurrence</u>	<u>Status</u>																										
9	14	Mar. 5, 1975	<p>Acquisition of signal returned at 03:06 UT, Mar. 5, 1976. At acquisition of signal, the configuration status was as follows:</p> <table border="0"> <tr><td>Sun angle</td><td>159.30</td></tr> <tr><td>Avg therm pl</td><td>290.55 K (62.90 F)</td></tr> <tr><td>RTG power</td><td>64.15 W</td></tr> <tr><td>Res power</td><td>40.88 W</td></tr> <tr><td>Transmitter</td><td>A</td></tr> <tr><td>Receiver</td><td>OFF</td></tr> <tr><td>PCU</td><td>2</td></tr> <tr><td>PSE</td><td>ON</td></tr> <tr><td>PSE Htr</td><td>Forced OFF</td></tr> <tr><td>CPLLEE</td><td>STBY</td></tr> <tr><td>SIDE</td><td>UNK</td></tr> <tr><td>ASE</td><td>STBY</td></tr> <tr><td>DTREM</td><td>ON</td></tr> </table>	Sun angle	159.30	Avg therm pl	290.55 K (62.90 F)	RTG power	64.15 W	Res power	40.88 W	Transmitter	A	Receiver	OFF	PCU	2	PSE	ON	PSE Htr	Forced OFF	CPLLEE	STBY	SIDE	UNK	ASE	STBY	DTREM	ON
Sun angle	159.30																												
Avg therm pl	290.55 K (62.90 F)																												
RTG power	64.15 W																												
Res power	40.88 W																												
Transmitter	A																												
Receiver	OFF																												
PCU	2																												
PSE	ON																												
PSE Htr	Forced OFF																												
CPLLEE	STBY																												
SIDE	UNK																												
ASE	STBY																												
DTREM	ON																												
10	14	Jan. 18, 1976	<p>Loss of signal occurred at 19:29 UT. Commands transmitted to the station to turn the transmitters ON were unsuccessful. At loss of signal, configuration status was as follows:</p> <table border="0"> <tr><td>Sun angle</td><td>95.20</td></tr> <tr><td>Avg therm pl</td><td>322.07 K (119.60 F)</td></tr> <tr><td>RTG power</td><td>61.74 W</td></tr> <tr><td>Res power</td><td>36.51 W</td></tr> <tr><td>Transmitter</td><td>A</td></tr> <tr><td>Receiver</td><td>OFF</td></tr> <tr><td>PCU</td><td>2</td></tr> <tr><td>PSE</td><td>ON</td></tr> <tr><td>PSE Htr</td><td>Forced OFF</td></tr> <tr><td>CPLLEE</td><td>STBY</td></tr> <tr><td>SIDE</td><td>UNK</td></tr> <tr><td>ASE</td><td>STBY</td></tr> <tr><td>DTREM</td><td>ON</td></tr> </table>	Sun angle	95.20	Avg therm pl	322.07 K (119.60 F)	RTG power	61.74 W	Res power	36.51 W	Transmitter	A	Receiver	OFF	PCU	2	PSE	ON	PSE Htr	Forced OFF	CPLLEE	STBY	SIDE	UNK	ASE	STBY	DTREM	ON
Sun angle	95.20																												
Avg therm pl	322.07 K (119.60 F)																												
RTG power	61.74 W																												
Res power	36.51 W																												
Transmitter	A																												
Receiver	OFF																												
PCU	2																												
PSE	ON																												
PSE Htr	Forced OFF																												
CPLLEE	STBY																												
SIDE	UNK																												
ASE	STBY																												
DTREM	ON																												

CENTRAL STATION ELECTRONICS - Continued

<u>Item</u>	<u>Apollo mission</u>	<u>Initial date of occurrence</u>	<u>Status</u>
11	14	Feb. 19, 1976	Acquisition of signal returned at 02:32 UT. Status was as follows: Sun angle 117.50 Avg therm p1 308.79 K (95.70 F) RTG power 62.12 W Res power 30.49 W Transmitter A Receiver ON-Xtal B PCU 2 PSE ON PSE Htr Auto ON CPLEE ON SIDE UNK ASE STBY DTREM OFF
12	14	Mar. 17, 1976	Loss of signal; station configuration status was as follows: Sun angle 85.60 Avg therm p1 320.35 K (116.50 F) RTG power 61.94 W Res power 36.94 W Transmitter A Receiver ON-Xtal B PCU 1 PSE ON PSE Htr Forced OFF CPLEE STBY SIDE OFF ASE STBY DTREM ON

CENTRAL STATION ELECTRONICS - Continued

<u>Item</u>	<u>Apollo mission</u>	<u>Initial date of occurrence</u>	<u>Status</u>
13	14	May 20, 1976	Acquisition of signal; station configuration status was as follows: Sun angle 156.1° Avg therm pl 288.10 K (58.5° F) RTG power 61.61 W Res power 31.31 W Transmitter A Receiver ON-Xtal B PCU 2 PSE ON PSE Htr Auto ON CPLEE ON SIDE UNK ASE STBY DTREM ON
14	14	June 8, 1976	Loss of signal; station configuration status was as follows: Sun angle 23.4° Avg therm pl 295.33 K (71.5° F) RTG power 61.86 W Res power 33.04 W Transmitter B Receiver ON-Xtal B PCU 1 PSE ON PSE Htr Auto ON CPLEE ON SIDE OFF ASE STBY DTREM ON

CENTRAL STATION ELECTRONICS - Continued

<u>Item</u>	<u>Apollo mission</u>	<u>Initial date of occurrence</u>	<u>Status</u>
15	14	June 10, 1976	Acquisition of signal; station configuration status was as follows: Sun angle 45.80 Avg therm p1 298.56 K (77.30 F) RTG power 59.16 W Res power 27.71 W Transmitter B Receiver ON-Xtal B PCU 2 PSE ON PSE Htr Auto ON CPLEE ON SIDE OFF ASE STBY DTREM ON
16	14	Oct. 9, 1976	Loss of signal; station configuration status was as follows: (FILT = filter) Sun angle 82.60 Avg therm p1 318.74 K (113.60 F) RTG power 60.72 W Res power 35.85 W Transmitter B Receiver ON-Xtal A PCU 1 PSE ON/FILT IN PSE Htr Forced OFF CPLEE STBY SIDE OFF ASE STBY DTREM ON

CENTRAL STATION ELECTRONICS - Continued

<u>Item</u>	<u>Apollo mission</u>	<u>Initial date of occurrence</u>	<u>Status</u>
17	14	Nov. 12, 1976	Acquisition of signal; station configuration status was as follows: Sun angle 137.90 Avg therm p1 297.55 K (75.50 F) RTG power 56.92 W Res power 25.97 W Transmitter B Receiver ON-Xtal A PCU 2 PSE ON/FILT IN PSE Htr Auto ON CPLEE ON SIDE OFF ASE STBY DTREM OFF
18	14	July 30, 1977	Loss of signal; station configuration status was as follows: Sun angle 73.30 Avg therm p1 311.62 K (100.80 F) RTG power 58.58 W Res power 12.64 W (21-W PDR, ON) Transmitter B Receiver ON-Xtal A PCU 1 PSE ON PSE Htr Forced OFF CPLEE STBY SIDE OFF ASE STBY DTREM ON

CENTRAL STATION ELECTRONICS - Continued

<u>Item</u>	<u>Apollo mission</u>	<u>Initial date of occurrence</u>	<u>Status</u>																										
19	14	Aug. 4, 1977	<p>Acquisition of signal; station configuration status was as follows:</p> <table border="0"> <tr> <td>Sun angle</td> <td>130.30</td> </tr> <tr> <td>Avg therm pl</td> <td>289.77 K (61.50 F)</td> </tr> <tr> <td>RTG power</td> <td>57.58 W</td> </tr> <tr> <td>Res power</td> <td>13.04 W</td> </tr> <tr> <td>Transmitter</td> <td>B</td> </tr> <tr> <td>Receiver</td> <td>ON-Xtal A</td> </tr> <tr> <td>PCU</td> <td>2</td> </tr> <tr> <td>PSE</td> <td>STBY</td> </tr> <tr> <td>PSE Htr</td> <td>N/A</td> </tr> <tr> <td>CPLEE</td> <td>STBY</td> </tr> <tr> <td>SIDE</td> <td>UNK</td> </tr> <tr> <td>ASE</td> <td>STBY</td> </tr> <tr> <td>DTREM</td> <td>ON</td> </tr> </table> <p>The station was reconfigured to PCU 1 and PSE to ON by ground commands and appeared to be operating normally.</p>	Sun angle	130.30	Avg therm pl	289.77 K (61.50 F)	RTG power	57.58 W	Res power	13.04 W	Transmitter	B	Receiver	ON-Xtal A	PCU	2	PSE	STBY	PSE Htr	N/A	CPLEE	STBY	SIDE	UNK	ASE	STBY	DTREM	ON
Sun angle	130.30																												
Avg therm pl	289.77 K (61.50 F)																												
RTG power	57.58 W																												
Res power	13.04 W																												
Transmitter	B																												
Receiver	ON-Xtal A																												
PCU	2																												
PSE	STBY																												
PSE Htr	N/A																												
CPLEE	STBY																												
SIDE	UNK																												
ASE	STBY																												
DTREM	ON																												
20	12, 15, 16, and 17	N/A	<p>Performance of the Apollo 12, 15, 16, and 17 central stations was essentially nominal. Although the original design requirement for ALSEP was a 1-yr life, much longer useful lifetimes were realized.</p>																										
	12 to 17	N/A	<p>A summary of ALSEP status on Sept. 29, 1977, day before termination, is given in table 4-I.</p>																										

CENTRAL STATION ELECTRONICS - Concluded

<u>Item</u>	<u>Apollo mission</u>	<u>Initial date of occurrence</u>	<u>Status</u>
Note	15 & 17	Jan. 1, 1979	<p>After the termination of ALSEP support at JSC on Sept. 30, 1977, monitoring of the ALSEP transmitter was accomplished on an intermittent basis by the tracking stations. During the period Mar. to June of 1978, the Apollo 17 ALSEP stopped transmitting and also stopped responding to ground commands.</p> <p>The Apollo 15 RTG power output had degraded to a level that would not sustain both heater power and transmitter operation at lunar night. Therefore, transmitter operation was occurring during the warmer lunar daytime when more power was available. In approximately Aug. 1978, the transmitter signal stopped and attempts to command were unsuccessful. This indicates the RTG power degraded to below the threshold for transmitter operation.</p>

TABLE 4-1.- SUMMARY OF ALSEP STATUS (16:00 UT, Sept. 29, 1977)

Characteristic	Apollo 12	Apollo 14	Apollo 15	Apollo 16	Apollo 17
Deployed, ^a month/day/year	11/19/69	2/5/71	7/31/71	4/21/72	12/12/72
Lunar coordinates	23.5° W, 3.0° S	17.5° W, 3.7° S	3.7° E, 26.1° N	15.5° E, 9.0° S	30.8° E, 20.2° N
Operation period, lunations/days	98/2871	83/2290	77/2252	68/1987	60/1752
Phase (Sun angle)	Noon (89.7°)	Noon (95.6°)	Noon (116.7°)	Noon (128.5°)	Noon (143.8°)
Commands, total/week	33 333/93	18 754/59	41 104/39	26 886/113	40 187/105
Spurious changes	120	114	138	11	0
RTG power					
Initial/Present, W	73.6/42.7	72.5/58.4	74.7/36.0	70.9/61.1	75.4/58.5
Reserve, W	21.3	33.9	7.4	29.7	23.0
Central station					
Average therm. pt., K (OF)	304.6 (89.1)	318.1 (113.5)	308.8 (96.7)	308.9 (96.9)	291.2 (65.0)
Transmitter, A or B (date) ^b	B (7/8/74)	B (11/12/76)	B (8/20/76)	B (3/26/73)	A (12/9/74)
Processor, type (date) ^b	Y (8/25/76)	Y (8/24/76)	Y (10/19/76)	X (1/12/77)	X (8/74)
PCU, 1 or 2	Inoperative	Inoperative	Operative	Inhibited 5/72	Operative
Timer	Inoperative	Inoperative	Operative	Inhibited 5/72	(Inhibited 9/28/77)
Heaters	DSS-1(10 W), OFF PDR's - OFF	DSS-1(10 W), OFF PDR's - OFF	DSS-1(10 W), OFF PDR's - OFF	DSS-1(10 W), OFF PDR's - OFF	CAPM status: ON PDR's - OFF
Experiments:					
Passive Seismic Experiment	0, 0	0, 0	0, 0	0, 0	
Long period X/Y & Z, dB	-20	Forced OFF	Auto - ON	Forced OFF	
Short period Z, dB	Auto - ON	9/26/77	OUT (3/27/77)	OUT (3/27/77)	
Heaters	Z motor - OFF	OUT (11/17/76)	Off scale HIGH	Off scale HIGH	
Filter	OUT (3/27/77)	329.3 K	Uncaged	Out of tolerance	
Sensor DL-07 temp	Off scale HIGH	(133.7° F)	Uncaged	Out of tolerance	
Uncage circuit	Uncaged	Uncaged	Uncaged	Out of tolerance	
Experiments, active/operable	Dust detector ON	Dust detector ON CPLEE, STANDBY	Dust detector ON	LSM-ON	LSPE-STANDBY HFE-ON LSG-ON
Experiments, inactive/inoperable	SWS-OFF SIDE-OFF LSM-OFF	SIDE-OFF ASE-STANDBY	SIDE-OFF HFE-OFF SWS-OFF LSM-OFF	HFE-OFF ASE-OFF	LEAM-STANDBY LACE-STANDBY

^aThe EASEP, Apollo 11, was deployed 7/21/69 at 23.4° E and 0.7° N; lost uplink 8/25/69; lost downlink 12/14/69.

^bConfiguration since this date.

CAPM = automatic power management.

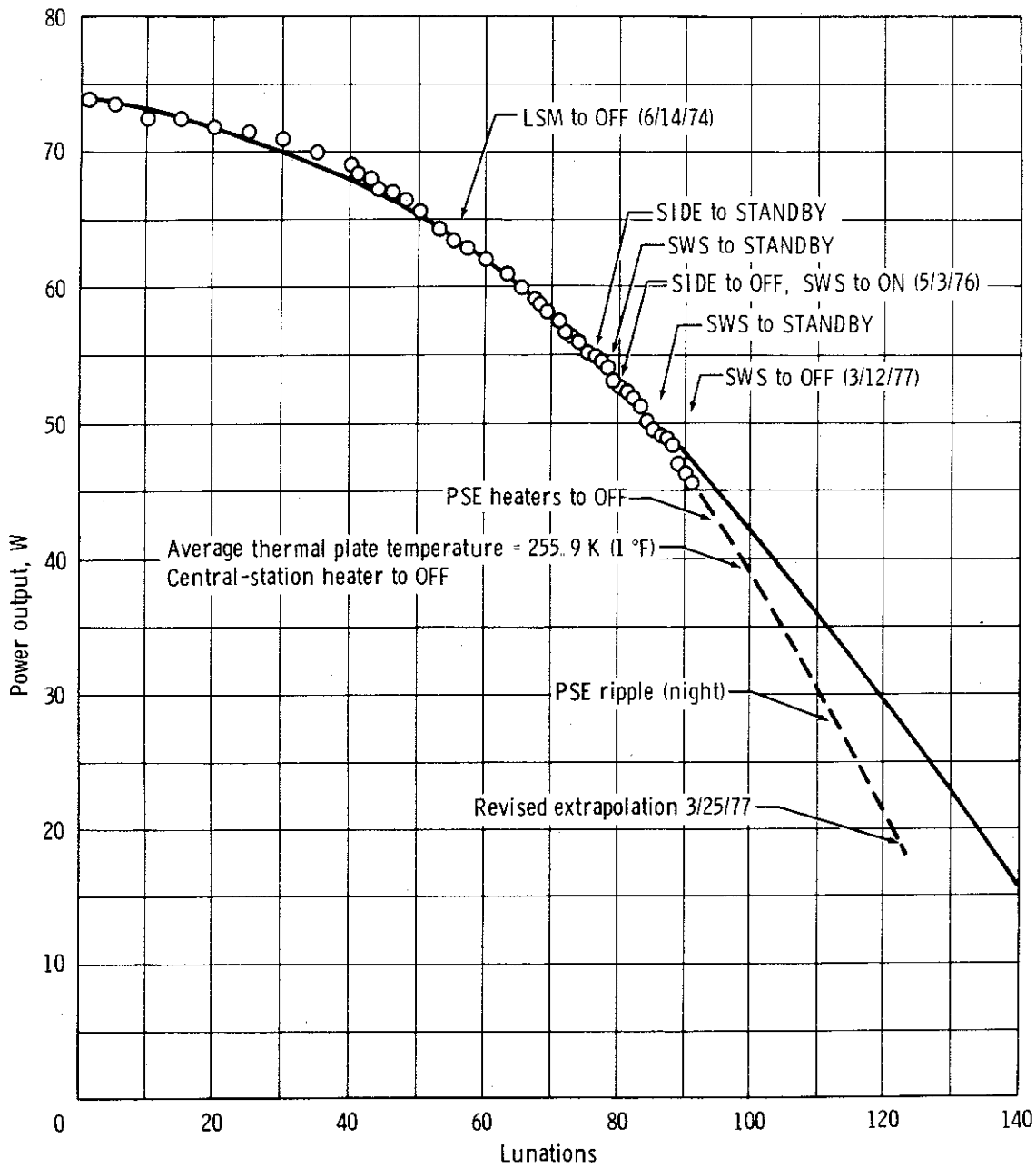

Figure 4-1.- Power output by lunation for Apollo 12 RTG.

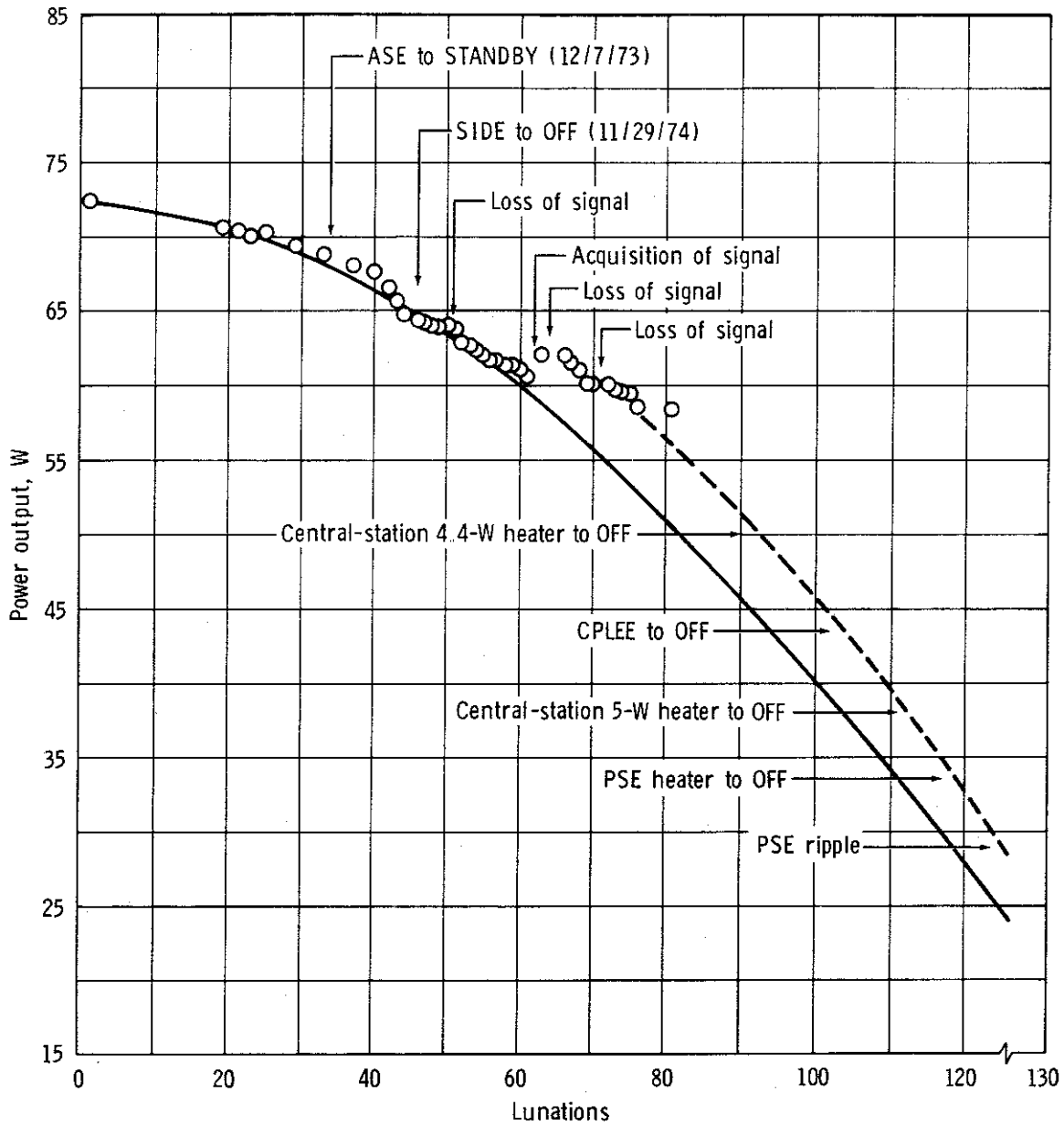

Figure 4-2.- Power output by lunation for Apollo 14 RTG.

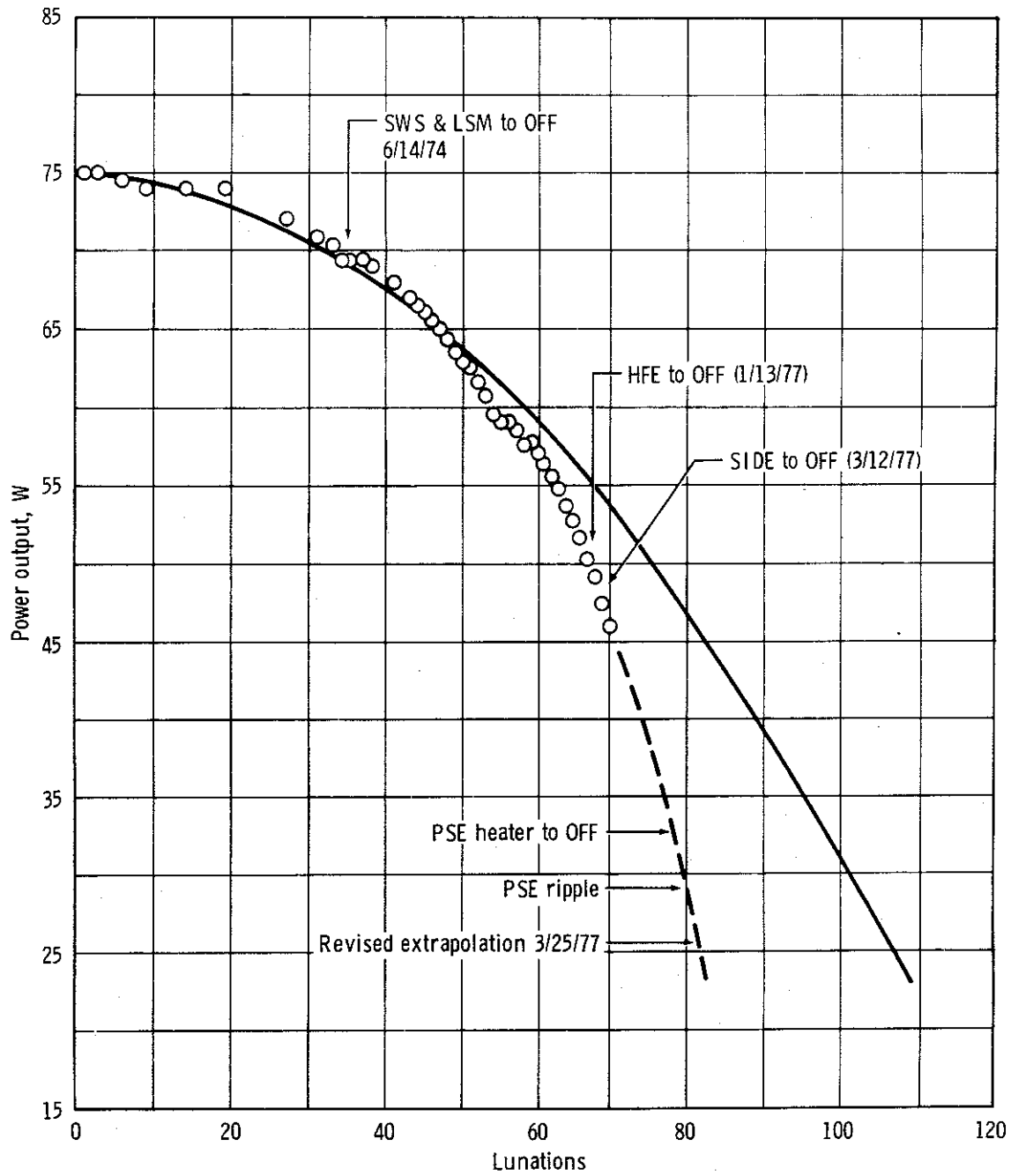

Figure 4-3.- Power output by lunation for Apollo 15 RTG.

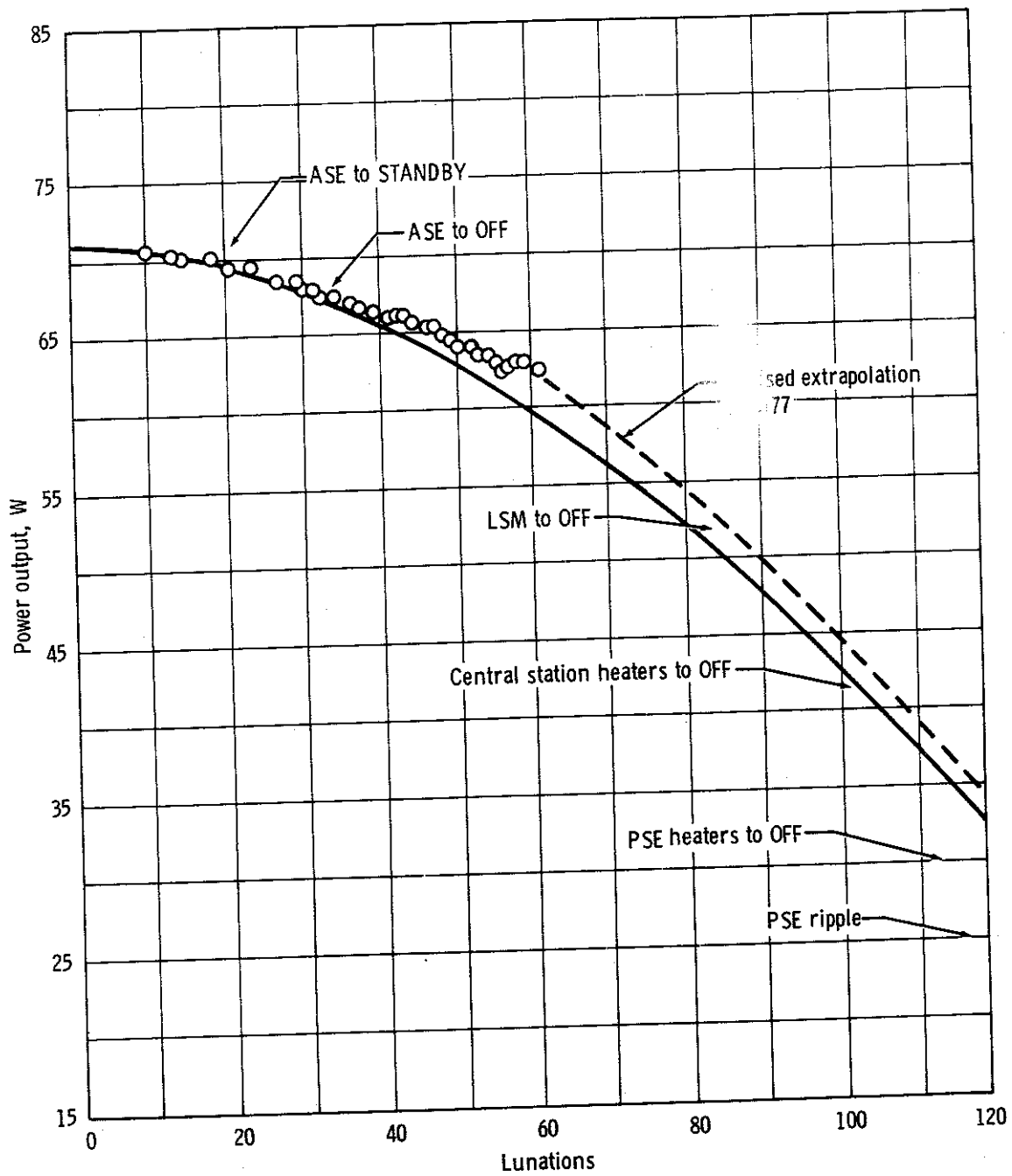

Figure 4-4.- Power output by lunation for Apollo 16 RTG.

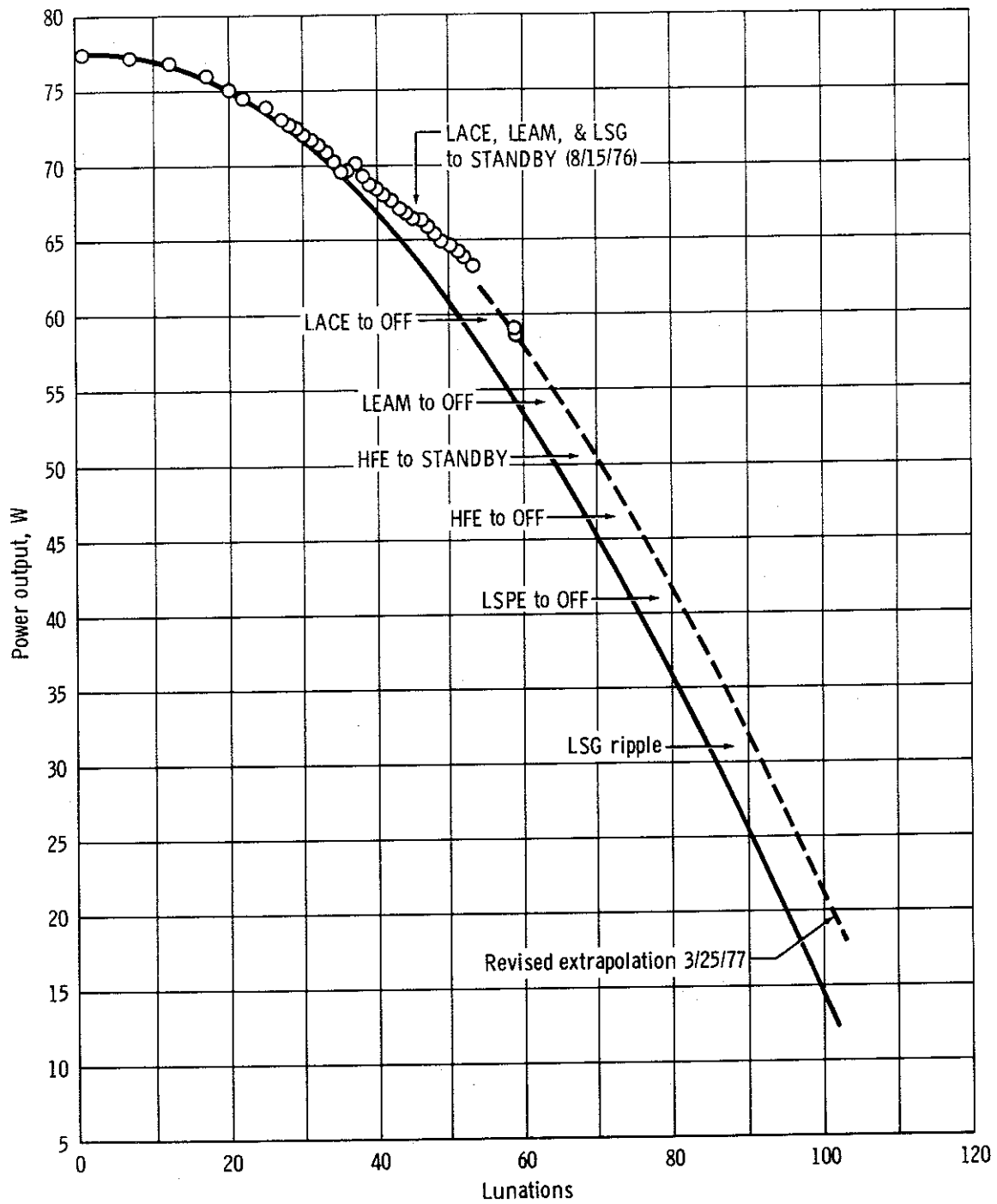

Figure 4-5.- Power output by lunation for Apollo 17 RTG.

5. TERMINATION ANALYSIS (ENGINEERING CLOSEOUT TESTS)

Support operations for the Apollo Lunar Surface Experiments Packages (ALSEP's) were terminated September 30, 1977, thus concluding the longest continuous program of scientific data collection from a natural body in space. Throughout the ALSEP program, operational guidelines and mission rules precluded the performing of engineering tests; the ALSEP operation was oriented toward optimizing all systems for scientific data return.

During the long period of ALSEP operation (July 20, 1969, to September 30, 1977), many engineering questions were raised but remained unanswered because of the operation constraint. Therefore, a period of engineering closeout testing was implemented before operations were terminated.

The series of engineering tests was devised approximately 3 months before support termination, and the tests were started July 25, 1977; they may be classified into six groups:

1. Overload and "ripple off" tests
2. Passive seismic experiment (PSE) heater power tests
3. Central station cold-temperature tests
4. Central station redundant components tests
5. ALSEP timer functions for Apollo 15 and 16 missions
6. Cold soaking of the lunar surface magnetometer (LSM) and lunar surface gravimeter (LSG) experiments

STATUS OF EXPERIMENTS

The following matrix indicates the status of ALSEP experiments before the tests were implemented. (The symbol "O" indicates the experiment was operating, the symbol "NO" indicates "not operating", and no entry (--) indicates the experiment was not part of ALSEP during that mission.)

<u>ALSEP unit</u>	<u>Apollo 12</u>	<u>Apollo 14</u>	<u>Apollo 15</u>	<u>Apollo 16</u>	<u>Apollo 17</u>
Central station	0	0	0	0	0
Passive Seismic Experiment (PSE)	0	0	0	0	--
Solar Wind Spectrometer (SWS)	NO	--	NO	--	--
Suprathermal Ion Detector Experiment (SIDE)	NO	NO	NO	--	--
Lunar Surface Mag- netometer (LSM)	NO	--	NO	0	--
Charged Particle Lunar Environment Experiment (CPLEE)	--	0	--	--	--
Heat Flow Experiment (HFE)	--	--	NO	NO	0
Active Seismic Experiment (ASE)	--	NO	--	NO	--
Lunar Surface Gravimeter (LSG)	--	--	--	--	0
Lunar Mass Spectrometer (LMS)	--	--	--	--	NO
Lunar Ejecta and Meteorites (LEAM)	--	--	--	--	NO
Lunar Seismic Profiling Experi- ment (LSPE)	--	--	--	--	0
Dust Detector (DTREM)	0	0	0	--	--

TEST CONSTRAINTS

The NASA Jet Propulsion Laboratory (JPL) needed the ALSEP transmitters for its very long base interferometer (VLBI) experiments and requested that the transmitters be left "on" after the termination of ALSEP operation in 1977. To comply with this request, and because of the remote possibility of dust contamination of the laser ranging retro reflector of the Apollo 14 site,

a decision was made that no destructive engineering tests or grenade firings would be attempted.

The Apollo 14 ALSEP operation was not continuous and its future operation was unpredictable. Therefore, a decision was made to cancel certain tests on the Apollo 12 ALSEP, thus precluding the possibility of its loss which would degrade the seismic network. (The downlink anomaly of the Apollo 14 ALSEP recurred on July 30, 1977, and downlink was recovered on August 4, 1977; this represented the sixth loss of signal for the Apollo 14 station.)

ENGINEERING TESTS

The engineering tests and their objectives are listed in this subsection by the Apollo mission number during which that ALSEP was deployed and by engineering test number. (The first two digits represent the Apollo mission number; the last digit represents the test sequence.)

As the tests were performed, it became evident that some of the tests could be canceled because

1. The necessary data or information was obtained by previous testing in the closeout test sequence
2. The test itself would or might have a serious impact on remaining operations

Apollo 12 ALSEP Tests

<u>Test no.</u>	<u>Type of test</u>	<u>Objective</u>
12-1	Overload the radioisotope thermoelectric generator (RTG) by turning on additional loads. Check the power gains at sunset and power losses at sunrise.	Determine if RTG power output could be rejuvenated as was the case for RTG power of Apollo 14.
12-2	Check "ripple off" circuit by turning SIDE and SWS to "standby."	Determine reserve power level (for PSE) at which "ripple off" occurs.
12-3	Check PSE heater power.	Determine power loads in various PSE heater modes.
12-4	Check PSE operation without Z-motor heating.	Determine leveling frequency and characteristics of drive motors.

<u>Test no.</u>	<u>Type of test</u>	<u>Objective</u>
12-5	Turn central station heaters off and turn the power dissipation resistors on to reach approximately 244 K (-20° F).	Pinpoint where PSE/central station-electronics anomaly starts and determine other central station characteristics at low temperature.
12-6	Turn central station heater(s) on to reach approximately 325 K (125° F).	Determine central station high-temperature operational characteristics and parameters.
12-7	Step the timer circuit seven times.	Determine status of timer electronics after 7 yr of operation.
12-8	Check redundant components of central station.	Determine operational status of alternate transmitter, processor, and power conditioning unit.
12-9	Command capabilities while in high-bit-rate mode.	Determine if the command system functions while in "HIGH BIT RATE" without ASE.

Apollo 14 ALSEP Tests

<u>Test no.</u>	<u>Type of test</u>	<u>Objective</u>
14-1	Heat central station power regulator by maximum reserve power or by central station heater.	Try to duplicate the cause of signal loss from Apollo 14 central station.
14-2	Check central station at approximately 325 K (125° F).	Check high-temperature operational characteristics and parameters.
14-3	Fire one or all ASE mortars; check high bit rate and geophones first and then check ASE "ARM CMD" in normal bit rate.	Eliminate live ordnance and check operation and thermal-protective seal after long lunar exposure.
14-4	Check PSE heater power.	Determine power loads in various PSE heater modes.
14-5	Turn central station heaters off and turn the power dissipation resistors on to reach approximately 244 K (-20° F).	Check central station low-temperature operational characteristics and parameters.

<u>Test no.</u>	<u>Type of test</u>	<u>Objective</u>
14-6	Check "ripple off" circuit by applying loads.	Determine reserve power at which CPLEE and PSE ripple to "standby."
14-7	Check redundant components of central station.	Determine operational status of alternate transmitter, data processor, and power conditioning unit.
14-8	Check timer steps.	Determine that timer electronics was still operational even with clock stopped.

Apollo 15 ALSEP Tests

<u>Test no.</u>	<u>Type of test</u>	<u>Objective</u>
15-1	Check PSE heater power.	Determine power loads in various PSE heater modes.
15-2	Check PSE operation without heater.	Determine leveling frequency and drive motor characteristics.
15-3	Turn the HFE on.	Determine if the data are static.
15-4	Turn central station heater(s) on to reach approximately 328 K (130° F).	Determine high-temperature operational characteristics and parameters of central station.
15-5	Check redundant components of central station.	Determine operational status of alternate transmitter, data processor, and power conditioning unit.
15-6	Allow timer to "time out."	Preclude resetting timer every sunrise.
15-7	Command capabilities while in high-bit-rate mode.	Determine if command system functions while in "HIGH BIT RATE" without ASE.
15-8	Overload the RTG.	Determine if RTG power output could be rejuvenated as was the case for Apollo 14.

Apollo 16 ALSEP Tests

<u>Test no.</u>	<u>Type of test</u>	<u>Objective</u>
16-1	Cold soak LSM.	Attempt to restore Z-axis data.
16-2	Fire last ASE mortar; check high bit rate and geophones first.	Verify that mortar can/cannot fire after long unsealed exposure.
16-3	Check PSE heater power.	Determine power loads in various PSE heater modes.
16-4	Turn central station heaters off and turn the power dissipation resistors on to reach approximately 244 K (-20° F).	Check low-temperature operational characteristics and parameters of central station.
16-5	Turn central station heater(s) on to reach approximately 325 K (125° F).	Check high-temperature operational characteristics and parameters of central station.
16-6	Check redundant components of central station.	Determine operational status of alternate transmitter, data processor, and power conditioning unit; verify that "Y" data processor had failed and that transmitter A had a "bad" modulator.
16-7	Allow timer to turn transmitter off.	Preclude resetting the timer every sunrise.

Apollo 17 ALSEP Tests

<u>Test no.</u>	<u>Type of test</u>	<u>Objective</u>
17-1	Cold soak LSG to 193 K (-80° C)	Attempt to improve operation by changing Lacoste spring constant.
17-2	Recheck LEAM operation during lunar day.	Verify if LEAM data are still static. If not, obtain 1 or 2 lunar days of data.
17-3	Operate HFE in high conductivity mode.	Obtain high conductivity-mode data for first time.

<u>Test no.</u>	<u>Type of test</u>	<u>Objective</u>
17-4	Check "ripple off" circuit by applying loads to central station.	Determine sequence and reserve power at which experiments "ripple off."
17-5	Turn power dissipation resistor no. 1 on to reduce central station to approximately 244 K (-20° F) (external loads).	Check low-temperature operational characteristics and parameters of central station.
17-6	Turn automatic power management off to increase central station to approximately 325 K (125° F).	Check high-temperature operational characteristics and parameters of central station.
17-7	Check redundant components of central station.	Determine operational status of alternate transmitter, data processor, and power conditioning unit; determine power routing of command decoder.

OVERLOAD AND "RIPPLE OFF" TESTS

Summary

Test 12-1.- Completed July 25, 1977; applied approximately 2 W overload; RTG input voltage dropped from 15.69 Vdc to 15.27 Vdc; bus voltages of central station dropped proportionally; data multiplexer became erratic. Overload was removed and the central station was returned to normal operation. This slight overload did not rejuvenate the RTG.

Test 12-2.- Completed July 25, 1977, as part of test 12-1. The PSE was "rippled off" (i.e., automatically placed in standby) at some value less than 1.79 W of reserve power.

Test 14-6.- Canceled because the test might cause the loss of the Apollo 14 ALSEP downlink and degrade the seismic network.

Test 15-8.- The test was canceled after a reevaluation of the possible consequences; i.e., possibility of permanent loss of downlink from Apollo 15 central station. Test 12-1 did not disclose any unexpected operation.

Test 17-4.- Test was canceled because the requirements were satisfied by the results of test 12-2.

Discussion

Tests 12-1 and 12-2 were performed during real-time support operations on July 25, 1977. The tests were conducted in conjunction with lunar sunrise at the Apollo 12 ALSEP site because a transient dip (approximate 5 W) in RTG power output occurred during this period.

Status prior to sunrise.- RTG power = 42.02 W; reserve power = 8.19 W; central station 10-W heater was ON; PSE and Z-motor were ON; SIDE was OFF; SWS was OFF; LSM was OFF; and the power dissipation resistors were OFF.

Sequence of test events.- The sequence of test events in universal time (UT) were

<u>Time, UT:</u>	<u>Event</u>
7:52	PSE Z-motor commanded OFF.
7:54	SIDE commanded to STANDBY (reserve power = 6.05 W).
8:05	At sunrise (by DTREM indication), the RTG power started gradually decreasing; also, the reserve power started gradually decreasing.
8:07	SWS commanded to STANDBY (reserve power = 2.32 W).
8:15	PSE rippled to STANDBY (reserve power = 1.79 W; then went to 2.85 W)
8:22	Central station heater commanded from 10 W to 5 W (reserve power = 6.85 W)
8:26	Power dissipation resistor no. 7 commanded ON (reserve power unknown; overload = 0.23 W). The 16-V bus was losing regulation; went to 15.69 V, to 15.27, still decreasing.
8:29	Dust detector (DTREM) commanded OFF; functional verification command receiver was operating.
8:50	Downlink signal started to breakup. Last valid reading on RTG power was 37.67 W.
8:54	Power dissipation resistor no. 7 commanded OFF (reserve power = 4.99 W). Immediate recovery; estimated 2+ W overload was applied. The RTG and reserve power gradually started increasing.

Test termination.- The RTG power output returned to the same post-sunrise level that had been observed during the preceding lunation. The central station and experiments were reconfigured for daytime operation.

PSE-HEATER POWER TESTS

Summary

This test was conducted on each PSE (for Apollo 12, 14, 15, and 16 ALSEP's) to determine the amount of power required by the sensor heaters to maintain the sensor temperature at night; also for comparison with data obtained from an identical test performed in 1974.

Test 12-3.- Completed August 23, 1977, Sun angle was 358.5° . The test sequence was as follows:

<u>Heater mode:</u>	<u>Reserve power, W:</u>
AUTO, ON	17.95
AUTO, OFF	17.42
MANUAL, ON	15.56
MANUAL, OFF	15.56
AUTO, ON	17.69

A power load of 4.76 W (included 3-W Z-motor) was required to maintain the sensor temperature at night. (No "HEATER, OFF" function at night.)

Test 14-4.- Completed September 20, 1977, Sun angle was 345.7° . The test sequence was as follows:

<u>Heater mode:</u>	<u>Reserve power, W:</u>
AUTO, ON	22.16
AUTO, OFF	22.00
MANUAL, ON	21.89
MANUAL, OFF	20.92
AUTO, ON	22.55

A power load of 4.5 W was required to maintain the sensor temperature at night. (No "HEATER, OFF" function at night.)

Test 15-1.- Completed September 19, 1977; Sun angle was 354.0°. The test sequence was as follows:

<u>Heater mode:</u>	<u>Reserve power, W:</u>
AUTO, ON	6.83
AUTO, OFF	11.50
MANUAL, ON	6.83
MANUAL, OFF	11.50
AUTO, ON	6.83

A power load of 4.67 W was required to maintain the sensor temperature at night.

Test 16-3.- Completed September 16, 1977; Sun angle was 329.3°. The test sequence was as follows:

<u>Heater mode:</u>	<u>Reserve power, W:</u>
AUTO, ON	10.60
AUTO, OFF	14.53
MANUAL, ON	9.81
MANUAL, OFF	14.79
AUTO, ON	9.55

A power load of 4.00 W was required to maintain the sensor temperature at night.

Discussion

Defects in the PSE heater circuits of the Apollo 12 and Apollo 14 ALSEP's precluded the turning off of the heaters; therefore, the PSE-heater power requirements for these ALSEP's were estimated. The PSE-heater power requirements of tests performed in 1974 are compared with 1977 termination-test data in the following table. (The PSE heater mode was "AUTO, ON" and data are the power requirements for maintaining the sensor temperature at night.)

<u>ALSEP</u>	<u>1974 test, W</u>	<u>1977 test, W</u>
Apollo 12	Not available	4.76 (estimated) Included 3-W Z-motor
Apollo 14	3.83	4.5
Apollo 15	4.74 to 4.89	4.67
Apollo 16	3.95	3.97

The two sets of data indicate the heater requirements are nearly identical; therefore, one may assume that the thermal integrity of the PSE sensors had not changed.

CENTRAL STATION COLD-TEMPERATURE TESTS

The cold-temperature tests (12-5, 14-5, 16-4, 17-5) did not produce any defects or anomalies that were not present at higher temperatures or that had not been reported prior to the cold-temperature tests. No cold-temperature tests were performed for the Apollo 15 ALSEP because the package was subjected to a nighttime temperature which was the lowest that it was possible to obtain. This situation existed because of the very low power reserve available (7.4 W), which provided very little heating in the central station. The RTG of the Apollo 15 ALSEP is the most degraded generator on the lunar surface (36.0-W output), hence the low power reserve. Therefore, test 15-5 was performed at an average thermal-plate temperature of 240.6 K (-26.9° F).

Summary

Test 12-5.- Completed August 12, 1977. All central station subsystems checked "good" at low temperature (244.9 K (-19.2° F) average thermal-plate temperature). Test also concerned the central station electronics anomaly. PSE analog-to-digital bit 3 was defective at temperature of approximately 254.3 K (-2.3° F). Transmitter A indicated a 15 kHz increase in frequency; transmitter B indicated a 20 to 22 kHz increase in frequency (both stabilized after "turn on").

Test 14-5.- Completed September 9 to 16, 1977. Operation of central station was normal at low temperature (average thermal-plate temperature was 257.0 K (2.6° F)).

Test 15-5.- Completed September 12, 1977. All central station subsystems and bit rates were found to be operational. (PCU 2 not checked during the test.) Average thermal-plate temperature was 240.6 K (-26.9° F).

Test 16-4.- Completed September 12, 1977. (Average thermal-plate temperature of 250 K (-10° F).) All central station subsystems and bit rates were checked and found operational except "Y" data processor (first reported

defective January 2, 1977) and transmitter A (first reported defective March 26, 1973).

Test 17-5.- Completed September 9 and 14, 1977. (Average thermal-plate temperature of 232.7 K (-41.2° F.) Central station subsystems found operational except for defective modulation of transmitter B. Also, see test 17-7.

Discussion

The tests indicated no detrimental effects or anomalies induced as a result of exposing the ALSEP central stations to the low temperatures.

CENTRAL STATION REDUNDANT COMPONENT TESTS

The redundancy capabilities of ALSEP packages deployed during the various Apollo missions are indicated in the following matrix:

Redundancy capability	Built-in redundancy for Apollo mission -				
	12	14	15	16	17
Transmitter A or B	X	X	X	X	X
Digital data processor X or Y	X	X	X	X	X
Power converter unit 1 or 2	X	X	X	X	X
Receiver crystal oscillator A or B (automatic switching, not commandable)	X	X	X	X*	X
Command decoder A or B	X	X	X	X	X
Contingency low bit rate downlink	X	X	X	X	X
Command system A or B (receivers and command decoders)					X
Analog multiplexer X or Y					X
Power routing X or Y					X

*Two complete receivers online.

Summary

Test 12-8.- Completed August 12, 1977 (with test 12-5) and September 20, 1977. All central station subsystems and bit rates were found operational; PCU 2 was not checked in test 12-8 or 12-5.

Test 14-7.- Completed September 19, 1977. All central station subsystems checked "good" (PCU 2 not checked during this test), and all bit rates were operational (PCU 2 not checked). Note that PCU 2 was checked during the ALSEP downlink recovery.

Test 15-5.- Completed September 12, 1977. All central station subsystems and bit rates were found to be operational (PCU 2 not checked during this test).

Test 16-6.- Completed September 12, 1977. All central station subsystems were found operational except for defective "Y" data processor and transmitter A (see test 16-4).

Test 17-7.- Completed September 14, 1977. All redundant systems were found operational except command system A, which rejected 14 of the 15 commands, and transmitter B modulation, which made the data useless. Transmitter B was first reported defective on December 9, 1974. All bit rates were operational.

Discussion

Results of the tests indicated that all the redundant components were operational except the following:

<u>ALSEP mission</u>	<u>Component</u>
Apollo 16	"Y" data processor (first reported defective January 2, 1977)
Apollo 16	Transmitter A (first reported defective March 26, 1973)
Apollo 17	Command system A (first reported defective August 16, 1974)
Apollo 17	Transmitter B (first reported defective December 9, 1974)

When support operations were terminated, there had been no additional failures of any ALSEP redundant components.

TIMER "TIMEOUT" TESTS

Summary

Test 15-6.- Completed August 29, 1977. Timer did not perform the transmitter "turn off" function.

Test 16-7.- Completed August 29, 1977. Transmitter "turn off" by means of the timer occurred at 20:42:17 UT, August 29, 1977. The transmitter was commanded on by means of mode 1 commanding from the Ascension tracking station.

Discussion

The ALSEP systems for the Apollo 15 and 16 missions provided a "resettable timer" that had an output signal to turn the transmitter off at the end of 97 days; however, the timer would not reset itself to turn the transmitter "on." The transmitter could be turned on by ground command but the timer control of "TRANSMITTER OFF" was nullified; thus, if command capabilities were lost, the transmitter would continue to operate as long as sufficient power existed.

Normal operation of these ALSEP's was to reset the timers before station sunrise, thus precluding transmitter "turn off" by means of the timer. To implement tests 15-6 and 16-7, the timers were not reset.

The Apollo 16 transmitter "turned off" at 20:42:17 UT on August 29, 1977, and was commanded "on" again by the tracking station. Because of a failure in the timer logic, the "turn off" function did not occur for the Apollo 15 ALSEP transmitter.

The transmitters can be turned "off" or "on" by means of normal uplink commands. The Apollo 16 station was commanded on at the completion of the test to comply with the JPL request for use of the stations in its VLBI experiments.

No timer "timeout" tests were conducted for Apollo 12 and 14 missions because the mechanical timers for both missions had been defective since shortly after deployment on the lunar surface. The ALSEP timer for the Apollo 17 mission did not provide a "TRANSMITTER OFF" function.

COLD SOAKING THE LSM AND LSG EXPERIMENTS

Summary

Test 16-1.- Completed March 14, 1977. Test was unsuccessful.

Test 17-1.- Completed March 16, 1977. Temperature would not decrease to 193 K (-80° C). All LSG voltages decreased and the digital data became scrambled. The LSG command decoder became inoperative. Lowest temperature achieved was estimated at 198 K (-75° C). The test was terminated and was unsuccessful.

Discussion

Test 16-1 was conducted as a means to recover science data from a defective Z-axis sensor on the Apollo 16 LSM; test 17-1 was an attempt to balance the mass in the LSG sensor of Apollo 17.

For a brief cooldown period, the Apollo 16 LSM was commanded "off" at 18:57 UT on March 14, 1977, and was commanded back "on" at 22:02 UT of the same day. The cooldown and reinitiation of the LSM was an attempt to regain science data from the Z-axis sensor that had been static since March 1975. The attempt was unsuccessful; it was performed at the request of the Principal Investigator.

The Apollo 17 LSG was commanded "off" for cooldown between the operational support period of March 13 to 16, 1977, except for approximately 2 hours each day to obtain data. The instrument temperature was 198 K (-75° C) (estimated) at each data take. The digital data from the digital multiplexer became scrambled, whereas the analog data remained valid at these low temperatures. Attempts to move the beam from the top position have been unsuccessful. On March 16, 1977, the decoder would not execute commands that were transmitted by ground control.

CANCELED TESTS

The following tests were canceled for the reasons noted:

<u>Test</u>	<u>Reason</u>
12-4	Potential damage to drive motors with resultant degradation of the seismic network.
12-6	Possible damage to central station. With the unpredictable operation of the Apollo 14 ALSEP, loss of the Apollo 12 ALSEP would degrade the seismic network.
12-7	Timer stepping would turn "on" the SIDE. The SIDE is defective and possibly could overload the central station. Loss of the Apollo 12 ALSEP would degrade the seismic network.

<u>Test</u>	<u>Reason</u>
12-9	Verified on the Apollo 16 and Apollo 14 ALSEP's.
14-1	Loss of the Apollo 14 ALSEP would degrade the seismic network.
14-2	High temperatures in the central station could possibly cause the loss of this ALSEP and result in degradation of the seismic network.
14-3	Canceled because tests indicate that the arming capacitors will not charge.
14-8	Timer stepping would turn "on" the SIDE, which is defective and would possibly overload the central station and result in loss of the transmitter.
15-2	Data from LOS/AOS anomaly of Apollo 14 ALSEP indicate the drive motors will not drive at low temperatures. Test 15-1 indicates normal heater power at night.
15-3	Canceled because the HFE was defective; this could possibly overload the central station and result in loss of the ALSEP.
15-4	Canceled because the test could result in possible loss of the ALSEP.
15-7	Canceled because this information was obtained during the Apollo 14 and 16 ALSEP tests.
16-2	Canceled. An arming command was transmitted but arming capacitors would not charge. Mortar box was improperly oriented because of previous mortar firing (May 1972).
16-5	Canceled because of possible loss of the ALSEP.
17-2	The LEAM was checked during each support period; LEAM science data always defective.

<u>Test</u>	<u>Reason</u>
17-3	Canceled; Principal Investigator anticipated no usable data from the test.
17-6	Canceled because of possible loss of the ALSEP.

CENTRAL STATION CONFIGURATION AT TERMINATION
OF ALSEP OPERATIONAL SUPPORT

Operational support of the ALSEP program was discontinued on September 30, 1977. At the conclusion, the central stations were configured as follows:

(No entry (--) indicates the component is not applicable to that ALSEP.)

<u>Component</u>	<u>Apollo 12</u>	<u>Apollo 14</u>	<u>Apollo 15</u>	<u>Apollo 16</u>	<u>Apollo 17</u>
Transmitter	B	B	B	B	B
Receiver crystal	B	A	A	Unknown	Unknown
Data processor	Y	Y	Y	X	X
Power conditioning unit	1	1	1	1	2
Heaters	Off	Off	Off	Off	Unknown
Power dissipation resistors	Off	Off	Off	Off	Off
Command decoder	--	--	--	--	B
Receiver	--	--	--	--	B
Automatic power management	--	--	--	--	On
Power routing	--	--	--	--	W

6. SIGNIFICANT ALSEP SCIENTIFIC RESULTS

A new era in lunar science was initiated on July 21, 1969, when the first data acquisition was obtained from the Apollo 11 central station on the Moon. More sophisticated equipment and experiment packages evolved during the remaining Apollo missions that culminated with Apollo 17. A large amount of Apollo Lunar Surface Experiments Package (ALSEP) data and their interpretation have been published in numerous reports and publications. This section of the ALSEP Termination Report does not attempt to recapitulate the findings; instead, each ALSEP investigator was asked to briefly summarize the significant scientific results obtained from the ALSEP experiments. The participating investigators were

1. Passive Seismic Experiment - Gary V. Latham, University of Texas at Galveston, and Nafi Toksöz, Massachusetts Institute of Technology
2. Lunar Near-Surface Structure (Active Seismic) - Robert L. Kovach, Stanford University
3. Lunar Surface Magnetometers - Palmer Dyal, NASA Ames Research Center, and C. P. Sonett, University of Arizona
4. Suprathermal Ion Detector Experiment - John W. Freeman, Jr., Rice University
5. Lunar Heat Flow Experiment - Marcus G. Langseth, Columbia University
6. Charged Particle Lunar Environment Experiment - David L. Reasoner, Rice University
7. Cold Cathode Gage Experiment - Francis S. Johnson, University of Texas at Dallas
8. Lunar Mass Spectrometer - John H. Hoffman, University of Texas at Dallas
9. Lunar Surface Gravimeter - Joseph Weber, University of Maryland
10. Solar Wind Spectrometer - Conway W. Snyder, NASA Jet Propulsion Laboratory
11. Lunar Ejecta and Meteorites - Otto E. Berg, NASA Goddard Space Flight Center

PASSIVE SEISMIC EXPERIMENT

Five seismic stations were deployed on the Moon during Apollo missions 11, 12, 14, 15, and 16. The Apollo 11 station, powered by solar cells and intended for operation only during the lunar day, failed after exposure to the first nighttime period. The remaining four stations, powered by radioisotope thermoelectric generators, have operated continuously since their initial activation. These four stations constitute the Apollo seismic network. The network was completed in April, 1972, with the installation of the fourth station in the Descartes region of the southern highlands during Apollo 16. Each station contains four seismometers. Three of these seismometers form a triaxial set (one sensitive to vertical motion and two sensitive to horizontal motion), with sensitivity to ground motion sharply peaked at 0.45 Hz. The fourth seismometer is sensitive to vertical motion with peak sensitivity at 8 Hz.

Lunar Seismicity (By Gary V. Latham)

The seismic data indicate that there are three primary types of signals: (1) deep moonquakes, (2) shallow moonquakes, and (3) meteoroid impacts.

1. The deep moonquakes are repetitive, occurring at fixed locations and at monthly intervals (27 to 28 days) with remarkable regularity. The moonquake foci occur in two narrow belts in the nearside of the Moon. Both belts are 100 to 300 km wide, approximately 200 km long, and 800 and 1000 km deep. These events are clearly correlated with tidal deformation of the Moon.

2. The shallow moonquakes are located on or near the surface of the Moon, leaving a large gap in seismic activity between the zone of the shallow moonquakes and the deep moonquakes. There are no marked regularities in their occurrence. These events constitute a small proportion of the total observed seismic events; they are significant because of the high energy release. These events average approximately 5/yr, and are most likely less than 100 km deep.

3. The meteoroid impacts have a distinctive seismic characteristic in contrast to the two types of moonquake characteristics. The meteoroid impacts generate the largest observed signals.

There has been only one farside meteoroid impact registered by the seismic network.

Results from the analysis of Apollo seismic network data suggest that

1. Primitive differentiation occurred in the outer shell of the Moon to a depth of approximately 300 km.

2. The central region of the Moon is presently molten to a radius of between 200 and 300 km.

The best model for the zone of original differentiation appears to be a crust 40 to 80 km thick, ranging in composition from anorthositic gabbro to gabbro; overlying an ultramafic cumulate (olivine-pyroxene) approximately 250 km thick. The best candidate for the molten core appears to be iron or iron sulphide.

Structure of the Moon (By Nafi Toksöz)

The lunar seismic network established by the Apollo Program has provided the best data for determining the internal structure of the Moon. Seismic waves can penetrate through a terrestrial planet and provide detailed information about its interior. On the Moon, both artificial impacts and natural events (meteoroid impacts and moonquakes) were used as seismic sources. By using travel times and amplitudes of seismic phases together with the most advanced techniques of seismogram analysis, investigators have determined the existence of a lunar crust and properties of the lunar mantle and deep interior.

Crustal characteristics.- The determination of crustal structure, using artificial impacts in the Oceanus Procellarum region around the ALSEP stations of Apollo 12 and 14, was the first accomplishment. The crust is two layered, with a total thickness of approximately 60 km in this region. There is a secondary boundary at a 20-km depth. More recently, it has proved possible to determine the crustal thickness at the ALSEP 16 site by using crustal reverberation ("pegleg" multiples) that followed the S-wave arrivals from deep focus moonquakes. Preliminary results suggest that the total crustal thickness under ALSEP 16 is approximately 75 km and that the 20-km interface also exists under ALSEP 16. On the basis of ultrasonic measurements of seismic velocities on returned lunar samples, it is suggested that the crust is composed predominantly of anorthositic and gabbroic composition.

Using data from deep and shallow moonquakes and meteoroid impacts, determination of lunar structure is extended to great depths. The lunar upper mantle has a fairly homogeneous velocity structure down to depths of between 300 and 500 km. The compressional wave velocity is approximately 8 km/sec, and the shear wave velocity is approximately 4.6 km/sec. These velocities are consistent with an olivine or olivine-pyroxene composition, although other compositions are possible. The seismic quality factor Q , which describes the attenuation of seismic waves due to anelastic absorption as they traverse a medium, is approximately 5000 for P waves in this region. This very high value indicates that very little absorption is taking place, almost certainly because of a complete absence of water or other volatiles.

Below a depth of 300 to 500 km, there is a decrease in the seismic velocities. Arrivals from deep-focus moonquakes indicate that the seismic velocities in the depth range of 500 to 1000 km are 7.5 km/sec for compressional waves and 4.1 km/sec for shear waves. The quality factor Q for compressional waves in this depth range is approximately 1500. The changes in seismic velocity in this depth range could be due to the substitution of iron for magnesium in, for example, the olivine or pyroxene mineral series. Below a depth of approximately 1000 km, the attenuation

increases, probably due to increased temperatures toward the melting point. Sufficient data does not exist at present to determine whether a small molten core exists inside the Moon.

Moonquakes and tides.- From the time of their discovery, a class of events known as deep-focus moonquakes has presented a challenge to investigators. Unlike the overwhelming majority of earthquakes, moonquakes repeat "time after time" at the same focus at monthly intervals. This monthly periodicity is controlled by the tidal forces of the Earth upon the Moon, and, in fact, the rate of energy release also exhibits 206-day and 6-year periodicities, also controlled by the tides. There have been approximately 70 foci discovered so far, with focal depths between approximately 700 and 1100 km. All located epicenters except one lie on the near side of the Moon, but this is probably because the Passive Seismic Experiment array is on the near side of the Moon and not because deep-focus moonquakes are limited to the near side. Deep-focus moonquakes constitute the vast majority of teleseismic events observed by the ALSEP network, although they are small events, having a maximum Richter magnitude of 1 or 2.

Several questions arise regarding moonquakes. Why are they so deep? What forces are responsible for them? Are they related to tides? To answer these questions, theoretical calculations of the stress distribution due to tidal forces have been made using realistic models of the distribution of elastic constants within the Moon. According to these calculations, the concentration of focal depths between 700 and 1100 km is due to a decrease in the shear modulus in this region, thus localizing the stress in this region. The epicenters, however, do not correspond to local maximums in the tidal stress, and must be due to local inhomogeneities, possibly previously existing faults. The time history of the epicenters, which includes events of reversed polarity, follows the tidal cycles so closely that it appears likely that the tidal forces are a major factor for triggering deep-focus moonquakes.

LUNAR NEAR-SURFACE STRUCTURE (ACTIVE SEISMIC)

By Robert L. Kovach

Seismic refraction data obtained at the Apollo 14, 16, and 17 landing sites permit a compressional wave velocity profile of the lunar near surface to be derived. Although the regolith is locally variable in thickness, it possesses surprisingly similar seismic characteristics. Beneath the regolith at the Apollo 14 Fra Mauro site and the Apollo 16 Descartes site is material with a seismic velocity of ≈ 300 m/sec, believed to be brecciated material or impact-derived debris. Considerable detail is known about the velocity structure at the Apollo 17 Taurus-Littrow site. Seismic velocities of 100, 327, 495, 960, and 4700 m/sec are observed. The depth to the top of the 4700-m/sec material is 1385 m, compatible with gravity estimates for the thickness of mare basaltic flows, which fill the Taurus-Littrow valley. The observed magnitude of the velocity change with depth and the implied steep velocity-depth gradient of $>2 \text{ km sec}^{-1} \text{ km}^{-1}$ are much larger than have been observed on compaction experiments on granular

materials and preclude simple cold compaction of a fine-grained rock powder to thicknesses of the order of kilometers. The large velocity change from 960 to 4700 m/sec is more indicative of a compositional change than a change of physical properties alone. This high velocity is believed to be representative of the material that forms the lunar highlands.

LUNAR SURFACE MAGNETOMETERS

Three lunar surface magnetometers were successfully deployed on the Moon as part of the ALSEP program during the Apollo 12, 15, and 16 missions. Data from these instruments, together with simultaneous measurements from other experiments on the Moon and in lunar orbit, have been used to study properties of the lunar interior and the lunar environment.

Analyses of lunar magnetic data were used to study the following properties of the Moon:

1. Electrical conductivity, temperature, and structure of the lunar crust and deep interior
2. Lunar magnetic permeability and iron abundance, also the inferred limits on the size of a highly conducting lunar core
3. Lunar surface remanent magnetic fields: present-day properties, interaction with the solar wind, and origin by thermoelectric generation
4. Lunar environment: lunar atmosphere and ionosphere in the geomagnetic tail, also velocity and thickness of the magnetospheric boundaries

Lunar Electrical Conductivity and Structure

(By Palmer Dyal)

Electrical conductivity of the deep lunar interior has been investigated by using data from a total of seven lunar magnetometers to analyze the eddy-current response of the Moon. Extensive analysis of one exceptionally large transient has allowed substantial improvement in resolution and sounding depth for conductivity analysis. Also, a new technique has been applied to conductivity analysis in which simultaneous data are used from a network of one close-orbiting and two surface magnetometers. As a result, it has been found that the lunar conductivity rises rapidly with depth in the crust to approximately 10^{-3} mhos/m at a 200- to 300-km depth, which corresponds to the upper-mantle boundary reported in seismic results. From a 300- to 900-km depth, the conductivity rises more gradually to 3×10^{-2} mhos/m.

An upper limit has been placed on the average electrical conductivity of the lunar crust as the result of an investigation of toroidal induction in the Moon. In the analysis, a theory is developed for the spherically symmetric case of the induction field totally confined to the lunar

interior or near-surface regions by a highly conducting plasma. Both systematic instrumental errors and random errors have been included in the crustal conductivity analysis, in which it is concluded that for an average global crust thickness of approximately 80 km, inferred from seismic results, the crust-surface electrical-conductivity upper limit is approximately 10^{-8} mhos/m. The toroidal induction results lower the surface conductivity limit determined from eddy-current response analysis by approximately four orders of magnitude.

Lunar permeability.- Magnetic permeability and iron abundance of the Moon have been calculated by analysis of magnetization fields induced in the permeable material of the Moon. When the Moon is immersed in an external field it is magnetized; the induced magnetization is a function of the distribution of permeable material in the interior. Deployment of Apollo magnetometers on the lunar surface permitted simultaneous measurements of the total response field at the lunar surface as well as measurements of the external inducing field by an Explorer 35 magnetometer. The total response field \underline{B} measured at the lunar surface by an Apollo magnetometer is the sum of the external and induced fields:

$$\underline{B} = \underline{B}_e + \underline{\mu} \cdot \underline{B}_e$$

where \underline{B}_e is the external magnetizing field, $\underline{\mu} \cdot \underline{B}_e$ is the magnetization field induced in the permeable lunar material, and $\underline{\mu}$ is a function of the magnetic permeability.

From a data plot of the radial component of \underline{B} compared to the radial component of \underline{H} , the global lunar permeability has been determined to be $\mu = 1.012 \pm 0.006$. The corresponding global induced dipole moment is approximately 2×10^{14} T/cm³ (2×10^{18} G/cm³) for typical inducing fields of 10^{-8} T (10^{-4} G) in the lunar environment. The measured permeability indicates that the Moon responds as a paramagnetic or weakly ferromagnetic sphere and that the Moon is not composed entirely of paramagnetic material, but that ferromagnetic material such as free iron exists in sufficient amounts to dominate the bulk lunar susceptibility.

Iron abundance.- Under the assumption that the permeable material in the Moon is predominantly free iron and iron-bearing minerals, the lunar free iron abundance has been determined to be 2.5 ± 2.0 wt.%. Total iron abundance has been calculated to be 9.0 ± 4.7 wt.%. Other lunar models with a small iron core and with a shallow iron-rich layer have also been examined in light of the measured global permeability.

Core size limits.- The lunar magnetic permeability determined from magnetometer measurements has also been used to place limits on a possible highly conducting core in the Moon. For this analysis, the Moon is represented by a three-layer magnetic model: an outer shell of temperature T below the Curie point T_C , for which permeability μ is dominated by ferromagnetic free iron; an intermediate shell of $T > T_C$ where permeability is approximately μ_0 (permeability of free space); and a highly conducting core ($\sigma > 10^2$ mhos/m) modeled by $\mu = 0$. This core effectively excludes

external magnetic fields over time periods of days and therefore acts as a strongly diamagnetic region ($\mu \rightarrow 0$).

A theoretical analysis was conducted to relate the induced magnetic dipole moment to the core size. The induced dipole moment has been determined from simultaneous Apollo 12 and Explorer 35 measurements to be $(2.1 \pm 1.0) \times 10^{14} \text{ T/cm}^3$ ($(2.1 \pm 1.0) \times 10^{18} \text{ G/cm}^3$) and from simultaneous Apollo 15 and 16 measurements to be $(1.4 \pm 0.9) \times 10^{14} \text{ T/cm}^3$ ($(1.4 \pm 0.9) \times 10^{18} \text{ G/cm}^3$). The theoretical results show that the core size is a function of the depth of the Curie isotherm and lunar composition, and that a highly conducting core of maximum radius 535 km is possible for the extreme case of a magnesium-silicate dominated orthopyroxene Moon with a Curie isotherm depth of 250 km. Conductivity results verify this upper limit for a core of conductivity greater than 10 mhos/m. However, the minimum radius for a highly conducting core is zero, i.e., there is no positive indication at this time that any core of conductivity greater than 10 mhos/m need exist in the Moon.

Permanent magnetic properties of remanent fields.- The permanent magnetic fields of the Moon have been investigated using surface magnetometer measurements at four Apollo sites. A lunar remanent magnetic field was first measured in situ by the Apollo 12 lunar surface magnetometer that was deployed on the eastern edge of Oceanus Procellarum. The permanent field magnitude was $(38 \pm 3) \times 10^{-9} \text{ T}$ (38 ± 3 gammas), and the source of this field was determined to be local in extent. Subsequent to this measurement of an intrinsic lunar magnetic field, surface magnetometers have measured fields at the Apollo 14, 15, and 16 sites. Fields of $(103 \pm 5) \times 10^{-9} \text{ T}$ and $(43 \pm 6) \times 10^{-9} \text{ T}$ (103 ± 5 and 43 ± 6 gammas), at two sites located approximately a kilometer apart, were measured by the Apollo 14 lunar portable magnetometer at Fra Mauro. A steady field of $(3.4 \pm 2.9) \times 10^{-9} \text{ T}$ (3.4 ± 2.9 gammas) was measured near Hadley Rille by the Apollo 15 lunar surface magnetometer. At the Apollo 16 landing site, both a portable and stationary magnetometer were deployed; magnetic fields ranging between 112×10^{-9} and $327 \times 10^{-9} \text{ T}$ (112 and 327 gammas) were measured at five different locations over a total distance of 7.1 km at the Descartes landing site. These are the largest lunar fields yet measured.

Thermoelectric origin of crustal remanent magnetism.- Measurements of remanent magnetization in returned lunar samples indicate that magnetic fields of 10^{-7} to 10^{-4} T (10^3 to 10^5 gammas) existed at the surface of the Moon at the time of crustal solidification and cooling. A thermoelectric mechanism has been investigated to explain the origin of these magnetic fields. When the crust was still only a few kilometers thick, infalling material could have penetrated it, exposing the magma beneath and forming many lava-filled basins. The resulting model has two lava basins, with different surface temperatures, connected beneath the surface by magma. This configuration has the basic elements of a thermoelectric circuit: two dissimilar conductors joined at two junctions that are at different temperatures. The thermal electromotive force in the circuit depends on the electronic properties of the lunar crust and the plasma; in particular, on the difference in their Seebeck coefficients. For a relative Seebeck coefficient of $10^3 \mu\text{V/K}$, thermoelectrically generated magnetic fields ranging from approximately 10^{-6} to 10^{-5} T (10^3 to 10^4 gammas) are calculated depending on basin sizes and separations. These fields are large

enough to have produced the remanence in most of the returned lunar samples. Fields as high as approximately 10^{-4} T (10^5 gammas) (indicated for some returned lunar samples) are attainable from the model if one uses upper-limit values of the Seebeck coefficient and includes effects of solar-wind compression of lunar surface fields. The thermoelectric mechanism is compatible with the high degree of inhomogeneity found in measured remanent fields and with the absence of a measurable net global magnetic moment.

Apollo 12 and 15 Magnetometers

(By C. P. Sonett)

Two principal results of the Apollo 12 and 15 Lunar Surface Magnetometer Experiments, are (1) the discovery of a permanent magnetic field at the Apollo 12 site with a regional (1 to 100 km) scale and (2) the discovery that the Moon responds strongly to electromagnetic excitation by the solar wind. The permanent magnetic field was unexpected but is fully consistent with the discovery of paleomagnetism in Apollo 11 lunar samples. The Apollo 12 results have been extended by Explorer 35 mapping of the limb shocks. Very detailed maps of the regional magnetization have been made by the Apollo subsatellites.

The electromagnetic excitation is a new class of planetary excitation by the solar wind. It is of intrinsic interest from the standpoint of supersonic plasma flow past planets. From the standpoint of planetary interiors, a detailed procedure for electromagnetic sounding of the bulk electrical conductivity of the Moon's interior has been developed by using the excitation. Present-day research shows the absence of a metallized core of radius greater than 400 to 500 km but cannot yet rule out a core of smaller radius. Conductivity at depths of 100 to 500 km have yielded a model-dependent thermal gradient and heat flux consistent with the latest heat flow measurements. The persistence of a spikelike conductivity anomaly at a depth of 150 to 250 km indicates that further work is required on increasing data resolution to confirm this characteristic.

The Apollo 15 data suggest that the Imbrium Basin is slowly settling. This result comes from model calculations based upon the Apollo 15 conductivity data that show a ringlike resistivity, increasing at the edges of the mare. Settling of Imbrium Basin had been previously suggested from studies of mascon anisostasy, lunar transient events, and seismic activity. The Apollo 15 conductivity is reported to be repeated at Mare Serenitatis by the Russian Lunikod data, thus increasing the likelihood that the Apollo 15 conclusion is correct.

The most recent research on Apollo 12 shows that the Moon is excited electromagnetically by pressure fluctuations in the darkside diamagnetic cavity. These are driven by the solar wind. The cavity acts like a solenoid and the fringing field extends into the Moon. Thus, excitation is superimposed upon the normal frontside induction forced by the integral magnetic field.

SUPRATHERMAL ION DETECTOR EXPERIMENT

By John W. Freeman, Jr.

The results of the ALSEP Suprathermal Ion Detector Experiment (SIDE) may be divided into two categories: those pertaining principally to the Moon and its interaction with its environment and those pertaining to the Earth's magnetotail.

Regarding the first category, the SIDE demonstrated the acceleration and reimplantation of atmospheric ions by the solar wind. By fitting the observed ion energy spectra to neon and argon masses, surface number densities for these gases were obtained near the terminator. Also, the electrostatic screening length of the surface electric field was obtained and found to be 2 orders of magnitude greater than expected from Debye screening length theory. This is believed to be due to the presence of a cloud of hot solar-wind electrons near the terminator presumably generated by the limb shock of the solar wind. The SIDE data provide the only evidence to date for such a cloud.

Efforts to find variations in the lunar atmosphere resulting from endogenous lunar gas emissions have been frustrating. The dayside lunar ionosphere number density was routinely monitored for many months by acceleration of ambient ions into the detector by the artificial electric field provided with the instrument. The ionosphere was found to vary with changes in the solar-wind flux and the extreme-ultraviolet (EUV) flux from the Sun. The solar-wind related enhancements suggest extensive sputtering of the lunar soil. These enhancements together with EUV modulations tend to mask atmospheric changes due to lunar sources. Only one possible natural event has been found to date. This event, principally water vapor, must remain suspect because of its proximity to the Apollo 14 mission. However, the large magnitude and the long time duration of the event argue against a mission related source.

Using SIDE data from other events, investigations have determined directly the dissipation time of rocket exhaust gases from the Apollo landing sites. The e-folding decay time for heavier gases is found to be approximately 1 month.

The SIDE made the first measurements of the electric potential of the lunar surface in the solar wind on the dayside and terminator side of the Moon. The Moon was found to be charged to approximately +10 V on the dayside going to -100 V at sunset and sunrise. The SIDE observation of sporadic fluxes of nightside ions suggests a nightside potential of approximately -250 V. The source of these nightside ions is not yet fully understood.

Regarding the second category, the SIDE made an important contribution to magnetospheric research by discovering a new plasma regime in the lobes of the magnetotail. This regime consists of low-energy plasma streaming along magnetic-field lines away from the Earth. The plasma, in addition to protons, is found to consist of singly ionized oxygen and/or nitrogen. The source of these ions is believed to be the Earth's ionosphere. This

has forced a reevaluation of current thinking regarding the source of the plasma mantle and boundary layer.

The SIDE has also provided the best data on the plasma sheet and magnetosheath at lunar distances. As a result, several new types of plasma sheet spectra have been found and asymmetries in the magnetosheath have been discovered. The SIDE has provided the first observation of direct entry of magnetosheath plasma into the plasma sheet. The SIDE has also been used to study the propagation of the bow shock protons upstream in the solar wind.

In summary, the SIDE has been a very successful experiment providing information on several different areas of space science. Data analysis is continuing and new aspects of the data are still being uncovered.

LUNAR HEAT FLOW EXPERIMENT

By Marcus G. Langseth

The Heat Flow Experiment was designed to make direct observations of the rate of heat loss through the surface of the Moon at the Apollo landing sites. Two of these experiments were deployed successfully during the Apollo program; one at Hadley Rille (Apollo 15) and the other at Taurus Littrow (Apollo 17). A third instrument was deployed at the Apollo 16 landing site, but a broken cable between the central station and the experiment made it useless. The principal components of the experiment were probes, each with 12 thermometers of exceptional accuracy and stability, that recorded temperature variations at the surface and in the regolith down to 2.5 m. The Apollo 15 experiment recorded temperatures for a period of 4.5 years and the Apollo 17 probes, which were still returning accurate results when the instrument was turned off, recorded 4 years and 10 months of lunar surface and subsurface temperatures. These data provided a unique and valuable history of the interaction of solar energy with lunar surface and the effects of heat flowing from the deep interior out through the surface of the Moon. The interpretation of these data resulted in a clearer definition of the thermal and mechanical properties of the upper 2 m of lunar regolith, direct measurements of the gradient in mean temperature due to heat flow from the interior, and a determination of the heat flow at the Apollo 15 and 17 sites.

Significant new observations that resulted from the experiment are as follows:

<u>Datum</u>	<u>Hadley Rille</u>	<u>Taurus Littrow</u>
Mean surface temperature, K	207	216
Maximum mean subsurface temperature of undisturbed regolith, K	253.0 (1.38 m)	256.7 (2.34 m)

<u>Datum</u>	<u>Hadley Rille</u>	<u>Taurus Littrow</u>
Thermal conductivity of the surface layer $\text{mW m}^{-1} \text{K}^{-1}$ (at 120 K)	1.2 ± 0.03	1.5 ± 0.03
Average conductivity below 10 cm, $\text{mW m}^{-1} \text{K}^{-1}$	$10 \pm 10\%$	$15 \pm 10\%$
Depth at which lunation fluctuations fall to 1% of surface value, m	0.29	0.33
Depth at which annual fluctuation falls to 1% of surface value, m	1.35	1.48
Mean vertical temperature gradient (most reliable probe), K/m	1.85	1.35
Observed surface heat flow, mW/m^2	21	16
Correction applicable to the observed heat flow due to terrain, percent	<4	-10

Surface temperatures and nature of shallow regolith.- Surface thermometers of the heat flow experiment provided a complete history of the surface variation of temperature during the observation period. Two important discoveries stemmed from the interpretation of these data.

1. A 30 to 35 K difference in mean temperature occurs across the upper few centimeters of the regolith because, in this relatively fluffy layer, radiative heat transfer predominates. At lunar noon, nearly 70 percent of the heat transfer in this layer occurs by particle-to-particle radiation.

2. The thermal response of the regolith to variations in solar radiation (due to eclipses, rotation of the Moon on its axis, and the eccentricity of its orbit about the Sun) are well described by a two layer model of the upper 2.5 m of the regolith, which is comprised of a thin (2 to 3 cm) surface layer of low density (1.1 to 1.2 g/cm^3) very fine material of extremely low conductivity (0.9 to $1.6 \text{ mW m}^{-1} \text{K}^{-1}$). This layer overlies a higher density (1.75 to 2.10 g/cm^3) tightly compacted layer of fines that have a quite uniform conductivity of 10 to $15 \text{ mW m}^{-1} \text{K}^{-1}$. The thermal conductivity of the deeper layer was determined by careful analysis of the downward propagation of long-term surface variations of temperature, such as the annual variations and disturbances caused by the visits of the astronauts to the sites. The value of conductivity inferred for this deeper layer is considerably higher than can be achieved by compaction of lunar soils in the laboratory, suggesting that on the Moon the soils below a few centimeters have been compacted into a mechanical configuration that has evolved over millions of years. This characterization of the lunar

soil layer will be important when the time comes to establish permanent bases or scientific stations on the lunar surface.

Temperature gradient and heat flow.- The increase of mean temperature with depth, due to heat flow from the interior, varies between the four sites as a result of local disturbances and regional variations in surface heat flow. The average gradient observed was 1.6 K/m. This value is in agreement with the vertical temperature gradients deduced from radiotelescope observations of long wavelength radiation from the whole disk of the Moon. The observed increase in brightness temperature with wavelength, when combined with the electromagnetic properties measured on Apollo soil samples, indicate a gradient of 1.5 to 2.0 K/m. The significance of this agreement is that it indicates that the mean of the four Apollo measurements is probably representative of the nearside of the Moon.

The observed mean gradient of 1.6 K/m and the thermal conductivity of the regolith below 3 cm combine to yield a heat flow of 17 mW/m^2 , with an estimated uncertainty of 20 percent. How representative this value is of the true average heat loss from the Moon is difficult to say with so few data that vary so widely. There is some evidence that suggests it may be quite representative. The large variations of heat flow that are observed over the surface of the Earth are mainly associated with the boundaries of converging and diverging lithospheric plates. The lithosphere of the Moon, on the other hand, is rigid and static so that variations associated with tectonics are unlikely. Regional variations in heat flow on the Moon are more likely associated with variations in abundance of long-lived radioactive isotopes of potassium, thorium, and uranium. These isotopes were mobilized by the igneous activity that formed the lunar crust and flooding of the mare basins. Orbital gamma-ray observations, global photomapping, and Apollo samples allow some estimates of the variability of heat flow. The investigators' analysis suggests that this variability is small. Lastly, a critical analysis of crust and mantle temperatures that would be implied by a heat flow between 12 and 18 mW/m^2 gives values that are in good agreement with seismic and magnetic data that depend on mantle temperatures. The heat-flow result implies temperatures within a few hundred degrees of melting at depths of approximately 300 km.

For a planet as small as the Moon, most of the heat escaping through the surface is produced by radioactive isotopes in the interior. If one assumes that this is the case for the Moon, then the observed heat-flow value would require a uranium content of approximately 30×10^{-9} to 45×10^{-9} g/g. This amount is similar to that estimated for the mantle of the Earth.

CHARGED PARTICLE LUNAR ENVIRONMENT EXPERIMENT

By David L. Reasoner

The Charged Particle Lunar Environment Experiment (CPLEE) consisted of a pair of ion-electron spectrometers designed to measure the characteristics of the lunar plasma environment. The lunar orbit exposes the Moon to a wide variety of plasma conditions, including the solar wind, the bow

shock formed by the solar-wind-Earth interaction, the magnetosheath, and the Earth's magnetic tail regions containing the plasma sheet. Thus, in one sense, the Moon served as a satellite to carry the only CPLEE instrument through various regions of space, and, in another sense, the CPLEE was a detector of phenomena resulting from the interaction of photons and charged particles with the lunar surface.

The CPLEE was deployed and activated as part of the Apollo 14 ALSEP on February 5, 1971. From the first moment of operations, the instrument began returning data on the layer of photoelectrons created by sunlight striking the lunar surface. Studies of the characteristics of these photoelectrons showed that the lunar surface reached a positive potential of 200 V in low density plasma conditions. Further study showed the modulation of the surface potential by charged particle fluxes and the effects of lunar remnant magnetic fields upon the photoelectrons.

A unique opportunity for plasma research was offered by the impact of the lunar module onto the lunar surface following transfer to the command service module. The impact resulted in an energetic ion-electron cloud detected by the instrument, and the time delay between impact and observation of the cloud showed that the plasma was being created and energized by the interaction between the solar wind and a neutral gas cloud produced by the impact.

The CPLEE was used to make extensive studies of the plasma characteristics of the distant regions of the Earth's geomagnetic tail and magnetosheath. The distribution of the plasma sheet was mapped, and the shadowing effects of the lunar surface upon the plasma sheet populations was investigated. The response of the plasma sheet to geomagnetic substorms was seen to be an increase in the plasma density and temperature, and the time delay between the substorm on Earth and its appearance at the Moon was about 1 hour. Geomagnetic storms were also found to produce large changes in the tail plasma populations and the locations of the tail boundaries. A significant discovery was the observation of electron populations in the magnetosheath that were typical of plasma sheet electrons, showing that particles and energy are able to traverse the magnetopause boundary.

During the lunar night portion of the orbit, when lunar surface photoelectrons were absent, the instrument was viewing into the downstream cavity of the solar-wind wake. Although a first-order treatment of the flow problem would predict a plasma void, it was found that significant low energy (up to 500 eV) electron fluxes were observed sporadically throughout the lunar night. One type of flux event was seen only when the interplanetary magnetic field connected the Moon to the Earth's bow shock region. These electrons were therefore energized at the bow shock and propagated upstream to the Moon. Another type of event was found to cluster near the terminators and were identified as a result of solar-wind interactions with the lunar terminators. These fluxes are significant in that, in the absence of sunlight and hence photoelectrons, they would charge the lunar surface to high negative (approximately 1000 V) potentials and would therefore be a source of electrostatic energy on the surface.

In summary, deployment of the CPLEE instrument on the lunar surface provided a wealth of new information on the interactions among photons, solar and terrestrial plasma populations, and the lunar environment.

COLD CATHODE GAGE EXPERIMENT

By Francis S. Johnson

The gages deployed on the lunar surface measured the amounts of gas present in the vicinity of the ALSEP sites. The observed daytime gas concentrations were initially approximately two orders of magnitude greater than the nighttime observations. This was almost certainly due to contamination of the landing site by the Apollo operations and equipment; the daytime measurements showed a decrease with time and was characterized by a time constant of a few months. The observed nighttime concentrations were approximately 2×10^{11} particles/m³; this probably represents the true ambient level because contaminant gases apparently "freeze out" at the low nighttime temperatures on the Moon (i.e., they are absorbed on the lunar surface). The nighttime concentration is in reasonable agreement with the amount of neon that should be expected from the solar wind, taking into account escape from the Moon and redistribution over its surface due to temperature gradients. Neon is the gas of solar wind origin that should be most abundant; heavier gases, whose escape from the Moon like neon is controlled by photoionization, are less plentiful than neon in the solar wind, and lighter gases escape more rapidly than neon due to thermal escape. However, the mass spectrometer on Apollo 17 indicated that helium is more important than neon, probably due to absorption of neon on the surface. Many transient gas clouds were observed, but these appear to have been released from Apollo hardware left on the lunar surface.

LUNAR ATMOSPHERIC COMPOSITION EXPERIMENT

By John H. Hoffman

The Apollo 17 ALSEP mass spectrometer experiment provided data on the distributions of argon-40 (⁴⁰Ar) and helium-4 (⁴He) in the lunar atmosphere. These are the most abundant gases. Because of a lack of atomic collisions, each gas forms an independent atmospheric distribution. Argon is absorbed on lunar surface soil grains at night, causing a nighttime concentration minimum. At the sunrise terminator, there is a sudden release of argon yielding a local abundance of 3×10^4 atoms/cm³. In contrast, helium is virtually noncondensable, and hence has a nighttime maximum of concentration in accordance with the classical law of exospheric equilibrium. The nighttime concentration maximum of helium was found to be 4×10^4 atoms/cm³. In addition, there is evidence in the data for the existence of very small amounts of ³⁶Ar ($\sim 2 \times 10^3$) methane, ammonia, and carbon dioxide ($\sim 10^3$ each) at the sunrise terminator and for nighttime upper bounds of ²⁰Ne ($< 4 \times 10^4$), ²²Ne ($< 5 \times 10^3$), and H₂ ($< 3.5 \times 10^4$). The total nighttime atmospheric abundance, however, is somewhat lower than was expected.

The measurements of ^{40}Ar and ^4He have been used in the synthesis of atmospheric supply and loss mechanisms. Essentially all the ^{40}Ar on the Moon comes from the decay of potassium-40 (^{40}K) in the lunar interior. Variability of the amount of atmospheric argon (a 6- to 7-month periodicity has been observed) suggests a localized source region. The magnitude of the average escape rate, approximately 8 percent of the total lunar argon production rate, indicates that the source may be a partially molten core with radius of approximately 750 km, from which all argon is released.

Most of the helium in the lunar atmosphere is of solar-wind origin, although approximately 10 percent may be due to effusion of radiogenic helium from the lunar interior. The atmospheric helium abundance changes in response to solar-wind fluctuations, suggesting surface weathering by the solar wind as a release mechanism for trapped helium. Atmospheric escape accounts for the radiogenic helium and approximately 60 percent of the solar-wind alpha-particle influx. The mode of loss of the remaining solar-wind helium is probably nonthermal sputtering from soil grain surfaces.

LUNAR SURFACE GRAVIMETER EXPERIMENT

By Joseph Weber

Approximately 1 year of data are recorded on magnetic tape for lunar surface vertical acceleration. The sensitivity is estimated to be a few angstroms (10^{-10} m) displacement in the vicinity of a narrow spectral band ($Q = 25$) in the vicinity of 1.5 hertz. The passband of the instrument is from dc to approximately 20 hertz.

Partial analysis of data has found no resonances corresponding to the lunar free modes of oscillation, and no evidence was found of correlation of lunar surface acceleration with coincidence events observed using the gravitational radiation detectors at the University of Maryland and at the Argonne National Laboratory. It should be noted that only extremely wideband phenomena would have been observed in such a correlation analysis. The Argonne-Maryland detectors have a very narrow passband in the vicinity of 1660 hertz, which is far from the lunar-surface-gravimeter passband near 1 hertz.

SOLAR WIND SPECTROMETER

By Conway W. Snyder

The solar wind spectrometers were deployed on the lunar surface during Apollo 12 and 15. The primary objective was to measure the properties of the solar-wind plasma that strikes the lunar surface, to compare these with the properties of the undisturbed solar wind in near-lunar space, and to determine whether any observed differences could provide information about the Moon.

At the Apollo 15 site, where the local magnetic field is approximately 3×10^{-9} T (3 gammas), the proton observations show no measurable differences when compared to upstream solar-wind data. Electron observations during solar-wind and magnetosheath periods are similar to expected upstream values except that particle shadowing sometimes occurs in certain directions and lunar photoelectrons are observed in the lowest energy channels. Lunar photoelectron yields, measured during magnetosphere passages, allow estimates to be made of the lunar surface electric potential when in the solar wind.

At the Apollo 12 site, where the local magnetic field is approximately 38×10^{-9} T (38 gammas), proton fluxes show compression, deceleration, deflection, and defocusing effects that depend in a complicated manner upon both solar-wind dynamic pressure and direction. Electron fluxes are typically peaked in the 80 to 160 eV channel during lunar morning, requiring the existence of a local electric field, which also accounts for proton deceleration. The failure of the magnetic field to have an even more substantial effect upon the plasma indicates that the scale size of the local magnetic field is no more than a few plasma wavelengths (5 km). Another mechanism that further tends to reduce the interaction is particle drifts caused by electric fields resulting from surface charge distributions produced by electron deflection currents. Compression of the local magnetic field at the Apollo 12 site by the solar wind occurs as part of the interaction and is an important source of magnetic fluctuations.

LUNAR EJECTA AND METEORITES

By Otto E. Berg

The lunar ejecta and meteorites (LEAM) instrument was designed to measure the speed, direction, total energy (kinetic and potential), and momentum of primary cosmic dust particles and lunar ejecta. The objectives of these measurements were

1. To evaluate the extent and nature of the meteoroid environment of cislunar space
2. To determine the extent and nature of lunar ejecta

However, the intended measurements were found to represent only a small part of the overall LEAM data events registered. Evidence of this phenomenon was manifest in several ways:

1. The experiment consistently recorded a high event rate (100 times the expected rates) associated with the passage of the terminators at the LEAM site.
2. The distribution of pulse heights (a function of the total energy of the particle) showed a preponderance of large (maximum for the experiment) pulse heights. The opposite was expected, based on the results of two similar experiments in heliocentric orbits.

3. An event counter of the experiment advanced several times per event. This anomaly could not be duplicated in the laboratory with hyper-velocity microparticles.

Several studies, both theoretical and experimental, were conducted to explain the LEAM data events. An investigation revealed that the LEAM would respond to highly charged, slow-moving microparticles with a high output pulse, thus, implying high energy impacts. Consequently, it was decided to expose the LEAM spare unit to laboratory microspheres having a large surface charge and moving at relatively slow speeds. Results indicated that the instrument would respond to charged (of the order of 10^{-12} C) particles having low speeds (of the order of 30 m/sec) with very large output pulses and with multiple counts.

Based on this analysis, the investigators concluded that the LEAM experiment was recording the transport of lunar surface fines.

7. SIGNIFICANT OPERATIONAL DATA (INCREASING TEMPERATURE)

Transmission of data from the lunar surface was terminated September 30, 1977. During their operational lifespan, the housekeeping data from all five Apollo Lunar Surface Experiments Package (ALSEP) central stations show a gradual temperature increase for which no definitive explanation exists.

Figures 7-1 to 7-4 are temperature plots (of parameter AT01) by lunation for the top structures of the ALSEP central stations deployed during the Apollo 12, 14, 15, and 16 missions. The smooth curves were hand drawn to the data points that represent maximum temperature for each lunation. Similar temperature profiles are included for the Passive Seismic Experiments (PSE), figures 7-5 to 7-8; the Suprathermal Ion Detector Experiments (SIDE), figures 7-9 and 7-10; the Apollo 17 Lunar Ejecta and Meteorite Experiment (LEAM), figure 7-11; and the Apollo 17 Lunar Mass Spectrometer Experiment (LMS), figure 7-12.

The cyclic pattern on all the temperature profiles is caused by the Sun/Moon elliptical orbit that produces a winter/summer effect on the lunar surface. This characteristic causes a semiannual change of approximately 5.5 K (10° F) at the lunar surface.

Central station temperatures (figs. 7-1 to 7-4) indicate that temperature continued to increase during more than 7 years of data collection. The rate of increase was more rapid during the early lunations. This characteristic is probably related to ultraviolet- or infrared-radiation degradation of the white thermal paint.

The PSE temperature profiles (figs. 7-5 to 7-8) do not show the same rapid increase during the first year of operation on the lunar surface as do the profiles in figures 7-1 to 7-4 (central stations). This difference is probably due to the aluminized Mylar used for PSE external thermal control.

White paint, the same as that used for the central station, was used for SIDE external temperature control; and the SIDE temperature profiles are shown in figures 7-9 and 7-10. In figure 7-9 (Apollo 12 SIDE), data points for the first 6 lunations are scattered because of the operating modes used during that period. However, notice that the figures indicate a rapid temperature increase similar to that for the central stations.

Figures 7-11 and 7-12 are temperature profiles of the Apollo 17 LEAM and LMS. The LMS (fig. 7-12) used mirrored surfaces for passive thermal control, and the LEAM used both mirrored surfaces and white paint.

As indicated in this cursory analysis, ultraviolet- or infrared-radiation degradation of the thermal coating was a factor contributing to the temperature changes. Other factors have been suggested, and these include

1. Earth-Moon/Sun eclipse relationships
2. Temperature transducer drifts
3. Dust buildup on the external surfaces
4. Other causes not yet determined

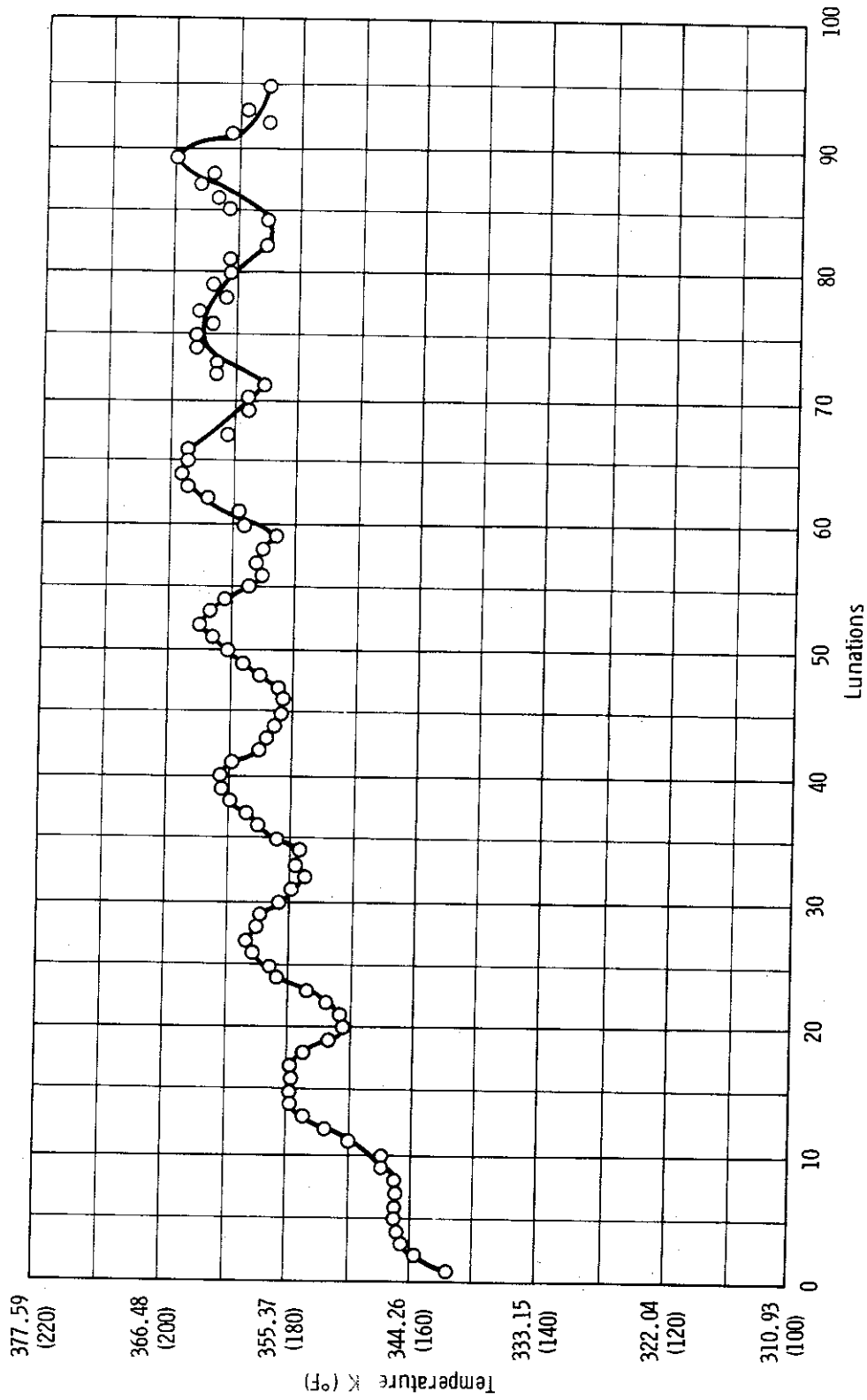

Figure 7-1.- Temperature profile for ALSEP central station of Apollo 12
(normalized to Sun angle of 90°).

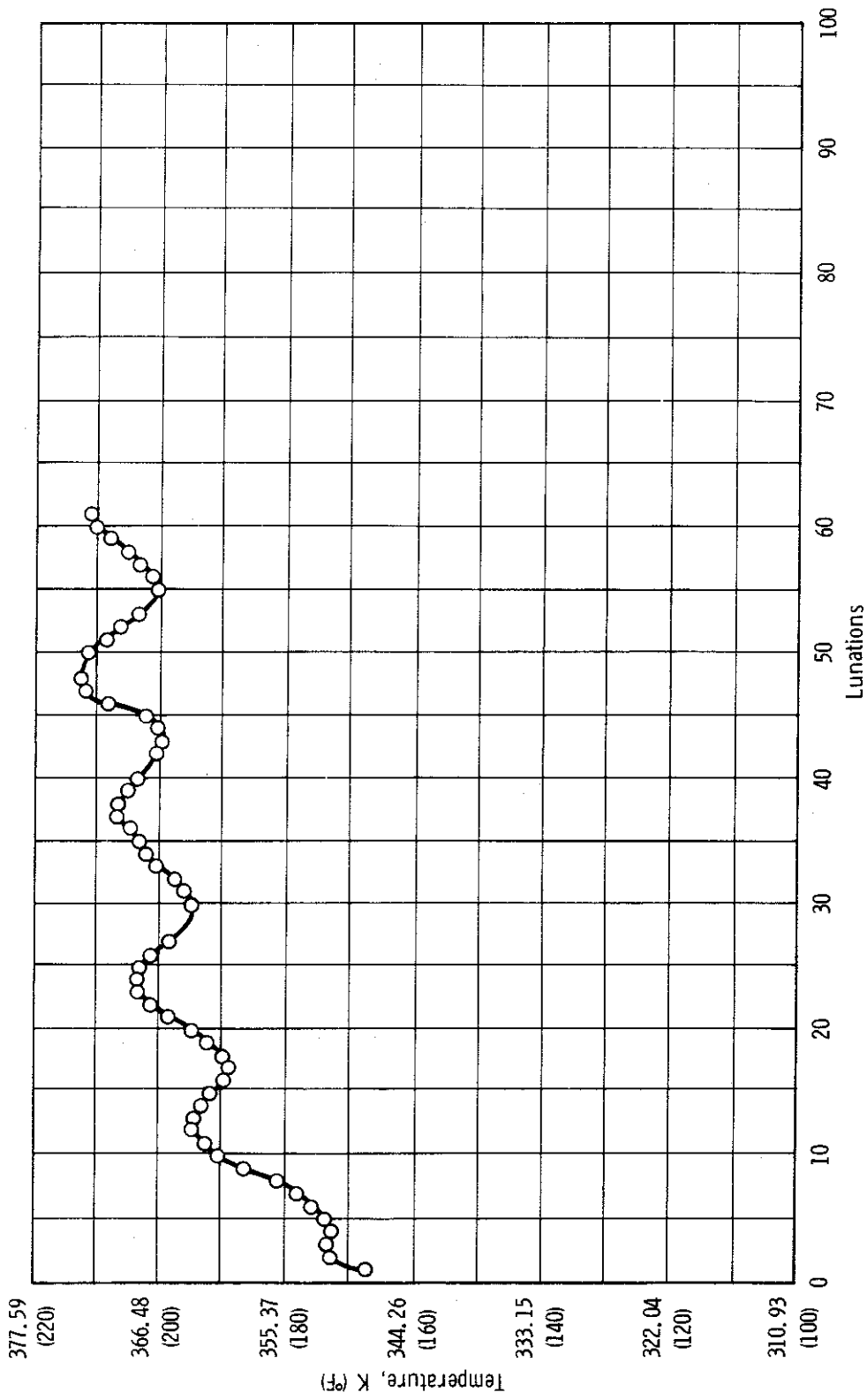

Figure 7-2.- Temperature profile for ALSEP central station of Apollo 14
(normalized to Sun angle of 90°).

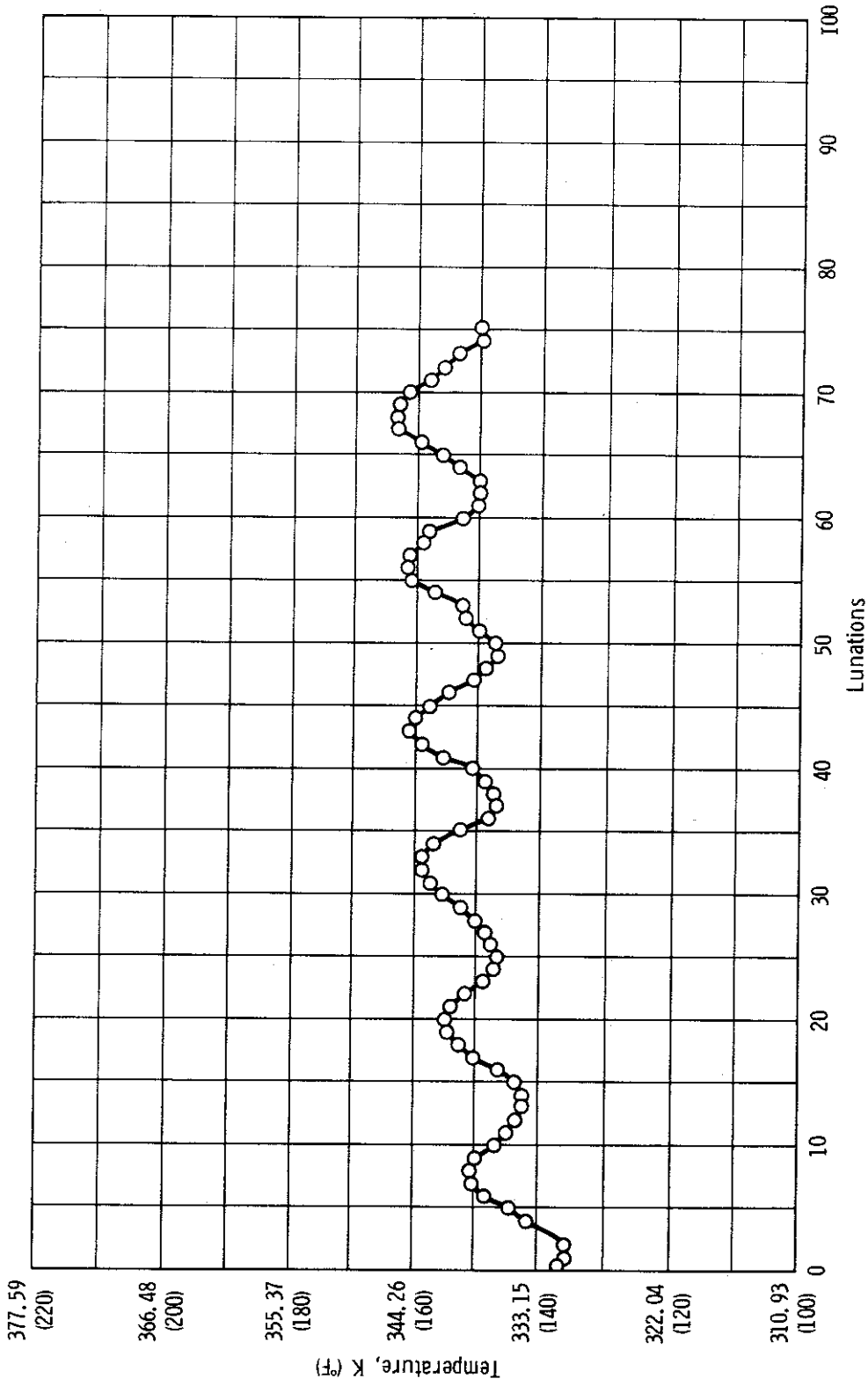

Figure 7-3.- Temperature profile for ALSEP central station of Apollo 15 (normalized to Sun angle of 90°).

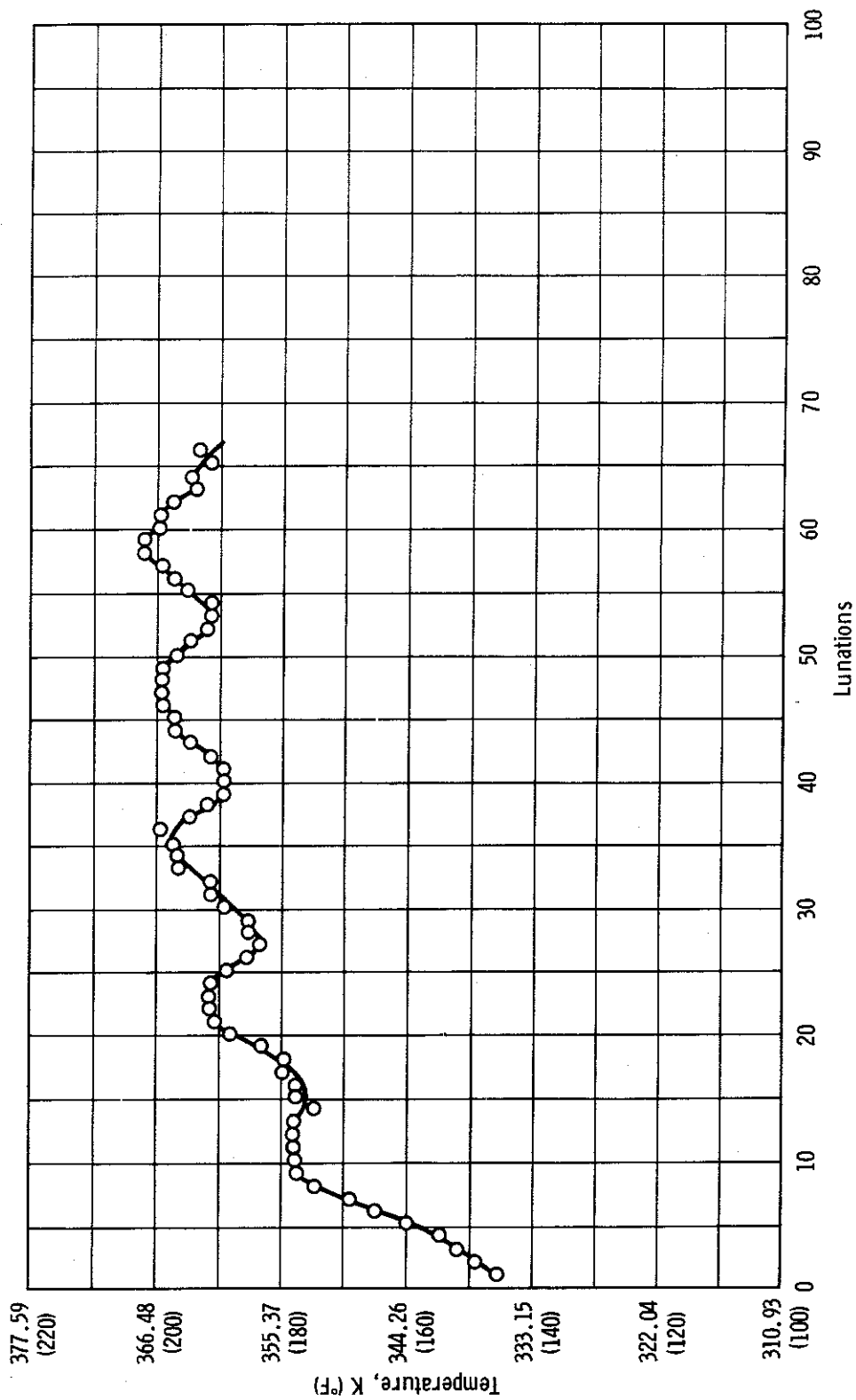

Figure 7-4.- Temperature profile for ALSEP central station of Apollo 16 (normalized to Sun angle of 90°).

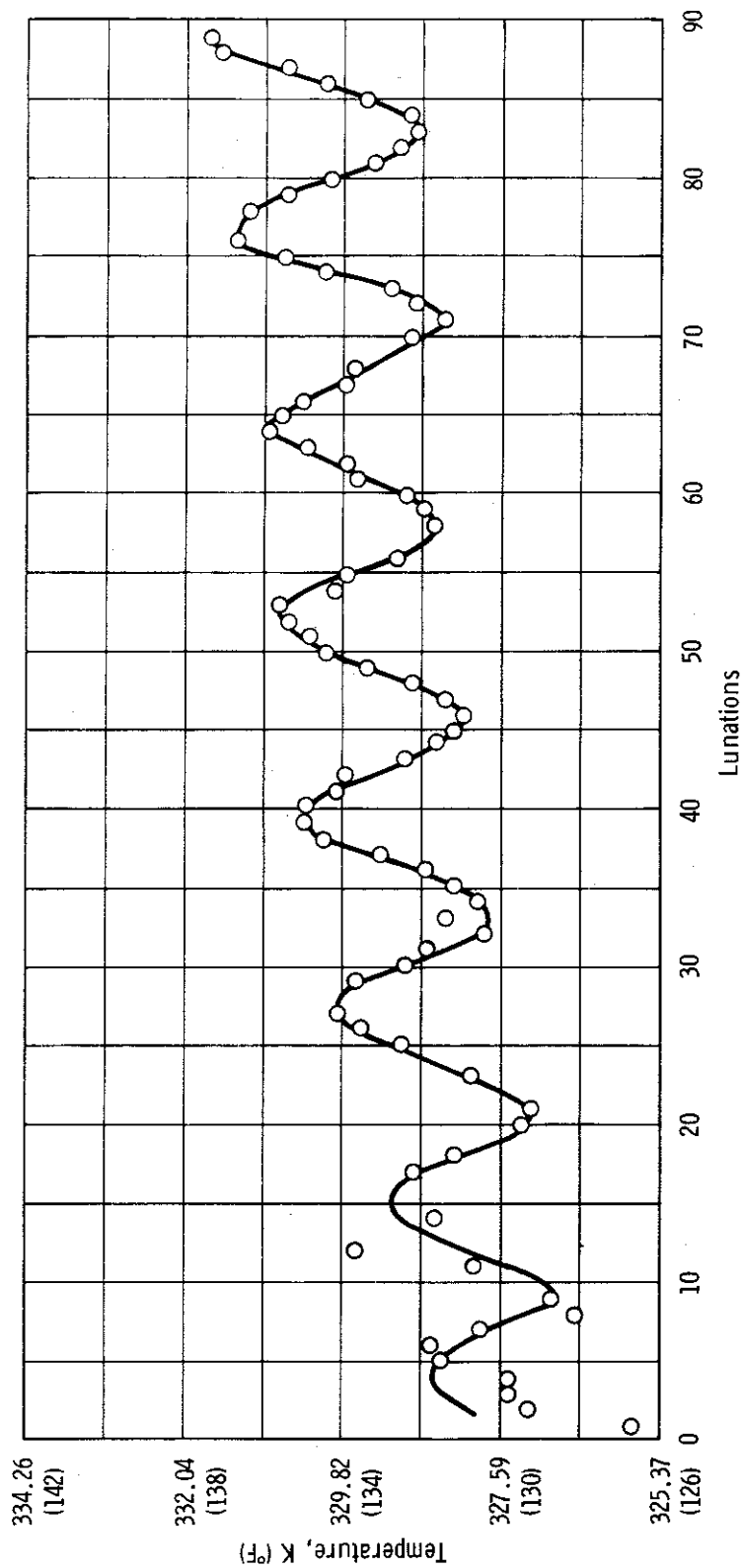

Figure 7-5.- Temperature profile for Passive Seismic Experiment of Apollo 12
(Sun angle = 70°).

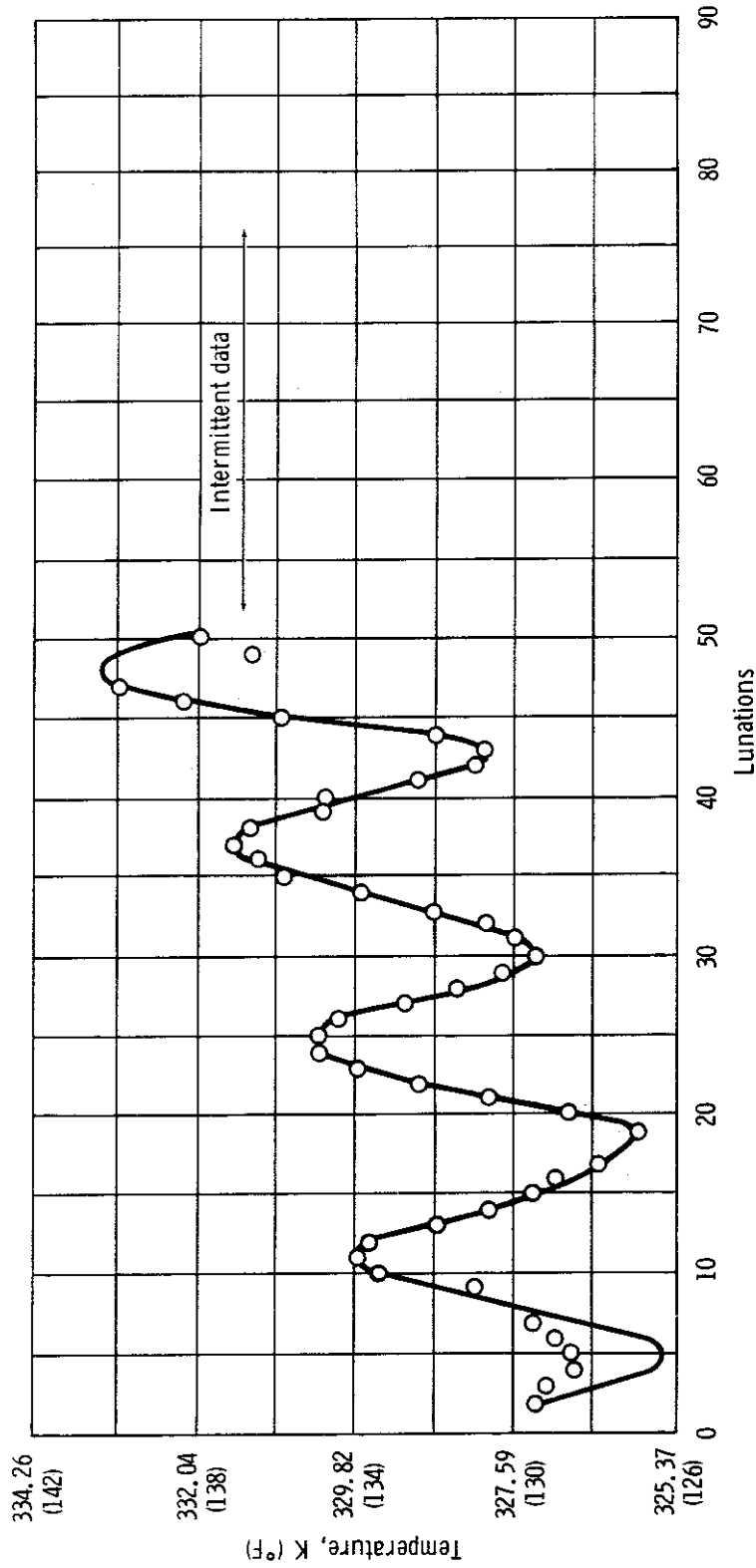

Figure 7-6.- Temperature profile for Passive Seismic Experiment of Apollo 14
(Sun angle = 90°).

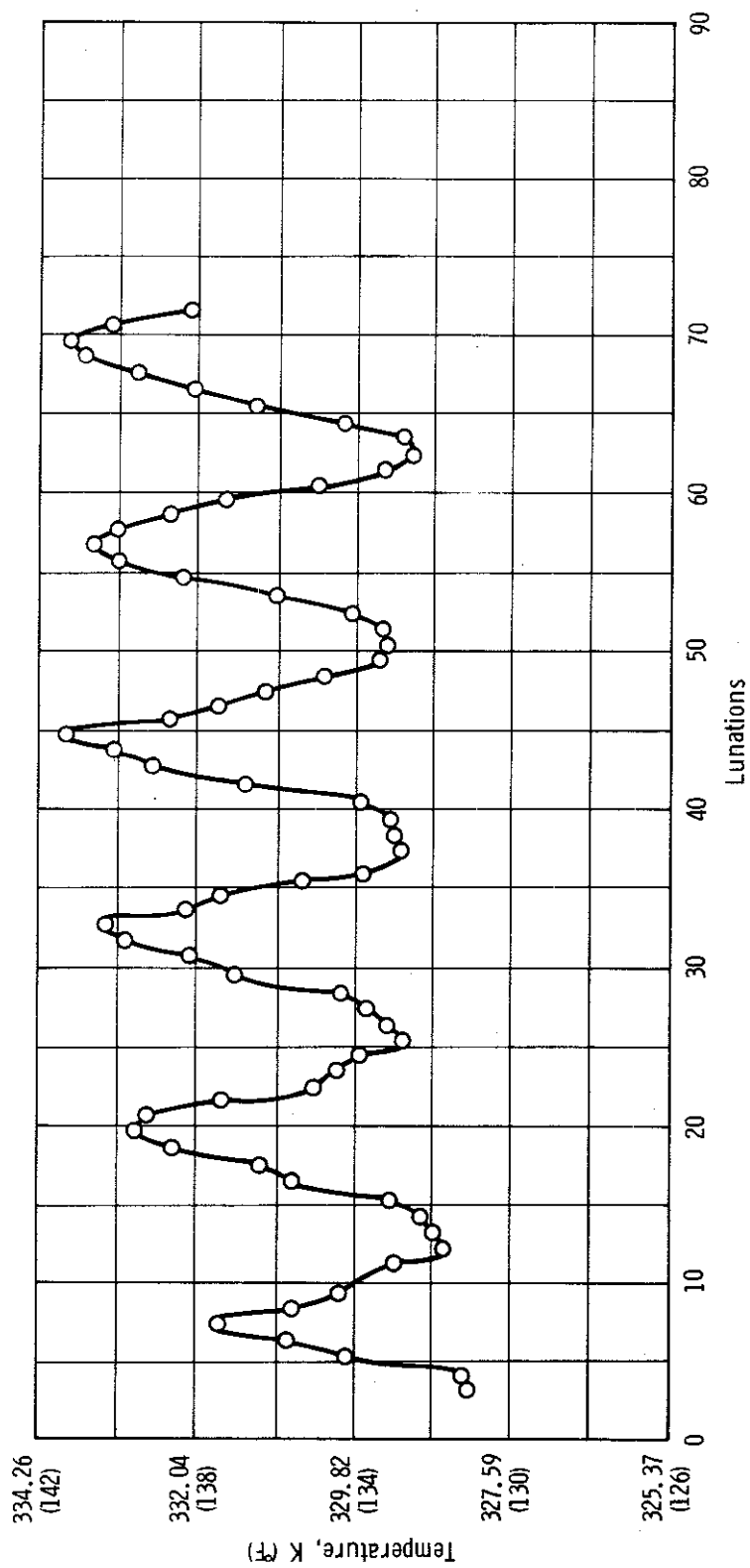

Figure 7-7.- Temperature profile for Passive Seismic Experiment of Apollo 15 (Sun angle = 60°).

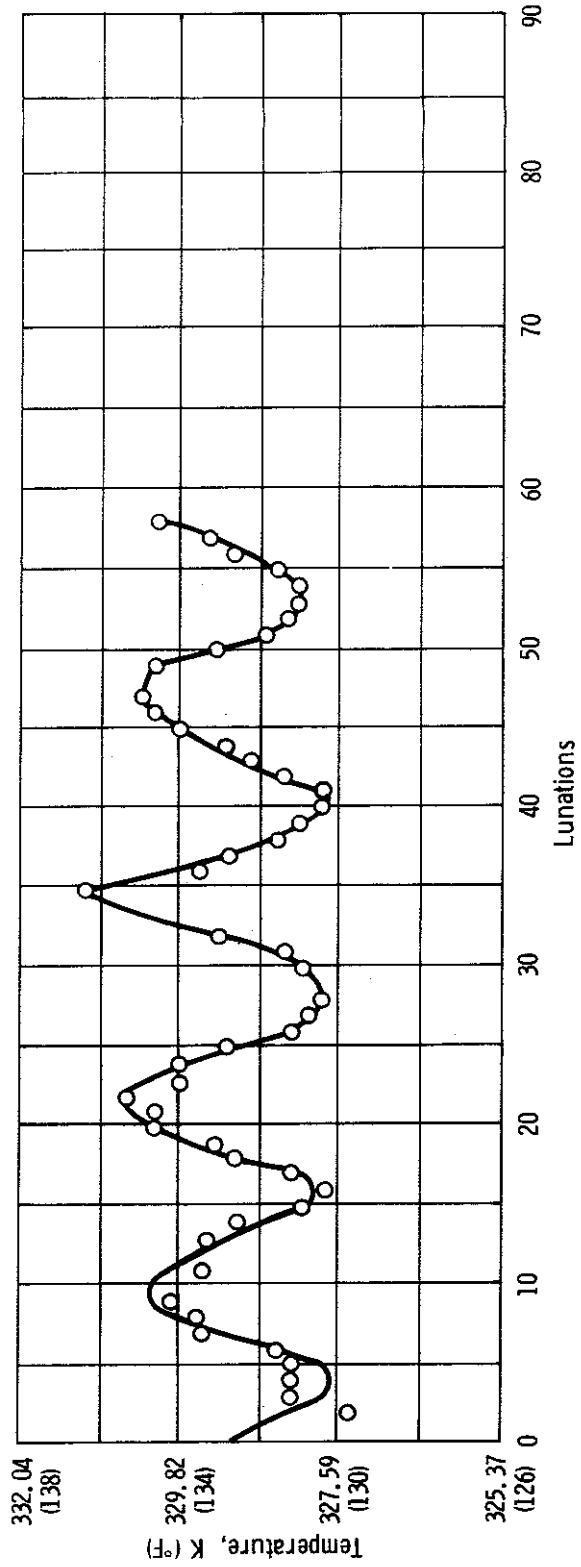

Figure 7-8.- Temperature profile for Passive Seismic Experiment of Apollo 16 (Sun angle = 55°).

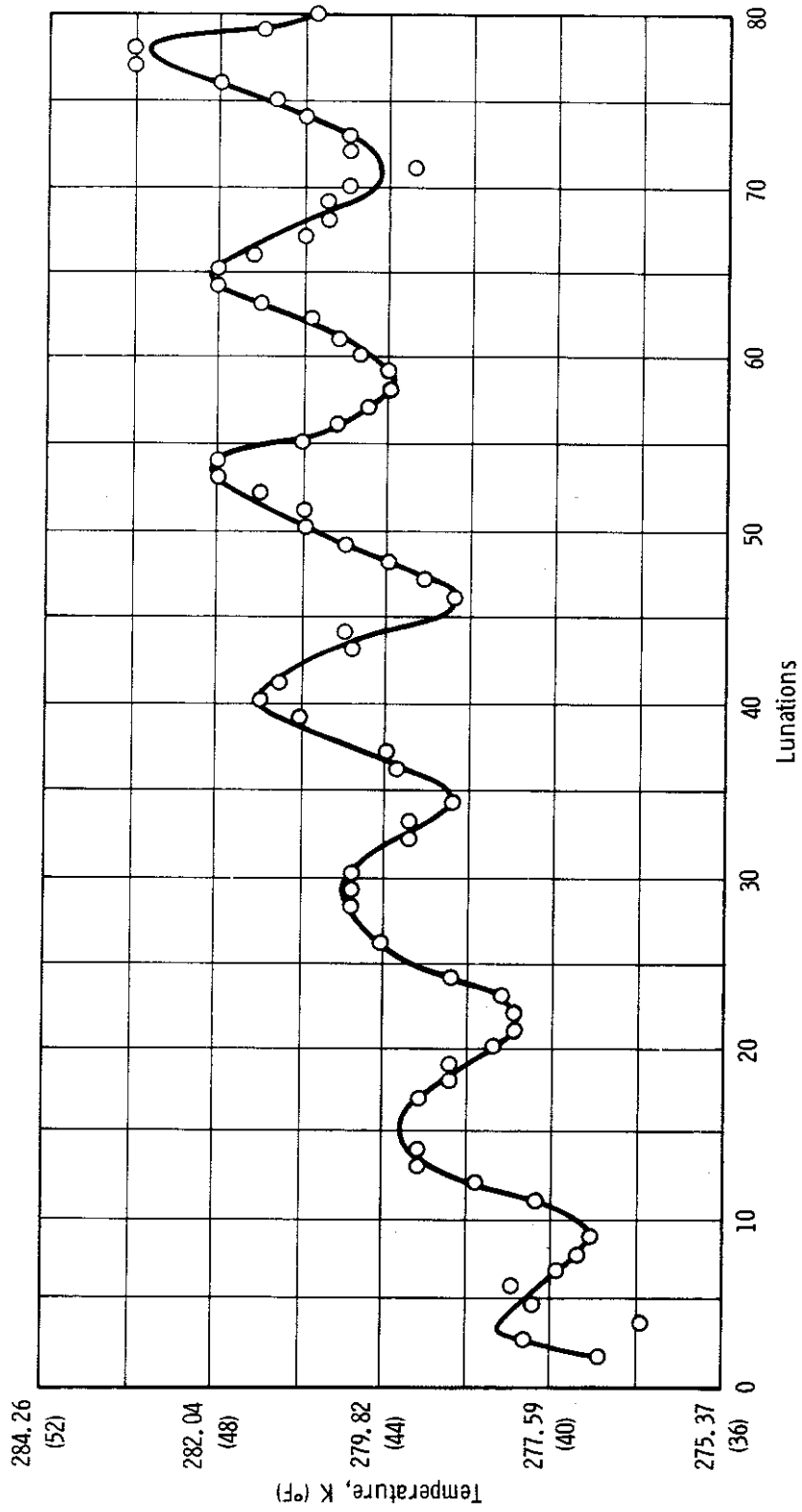

Figure 7-9.- Temperature profile for Apollo 12 SIDE (Sun angle = 20°).

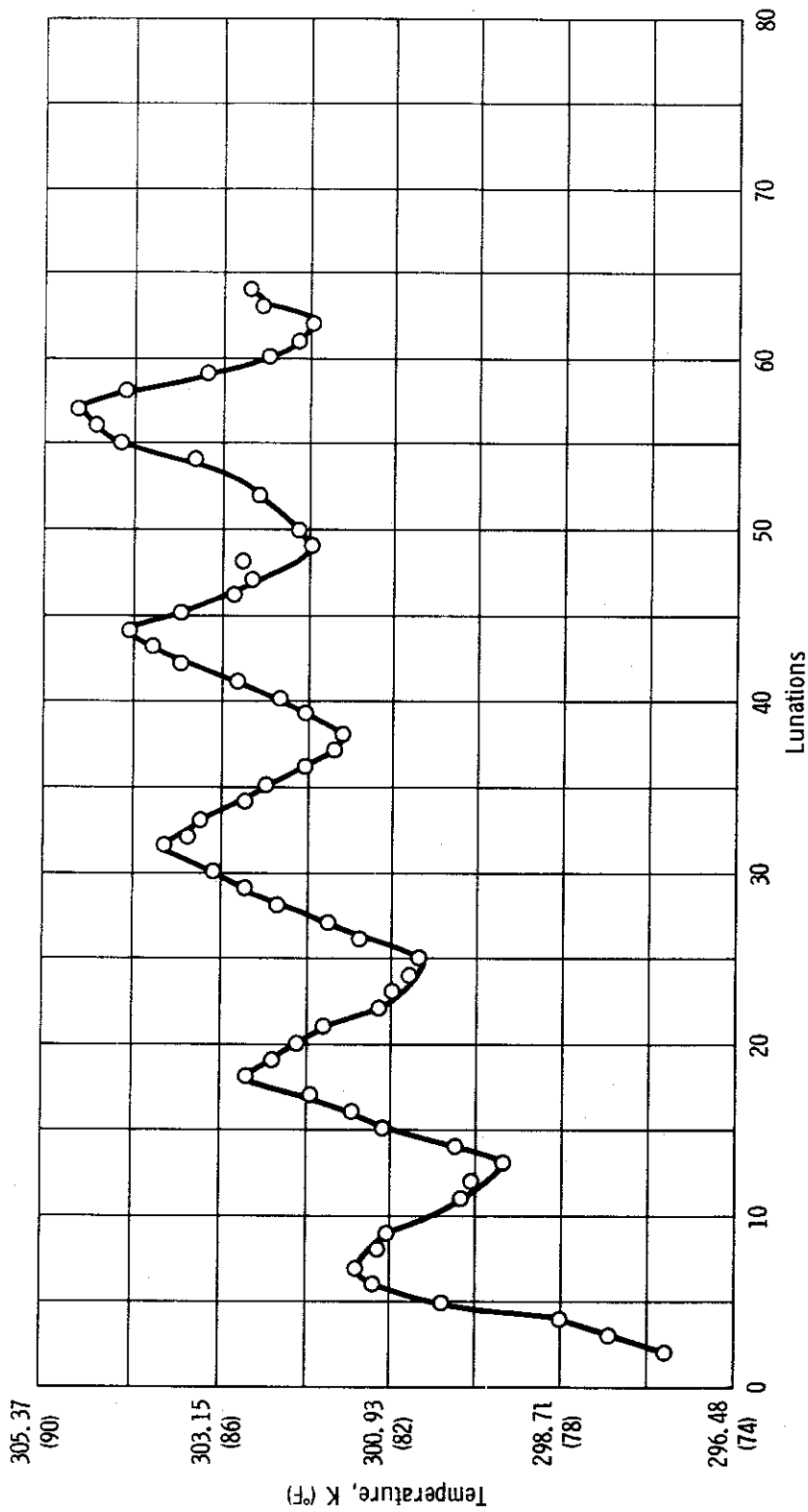

Figure 7-10.- Temperature profile for Apollo 15 SIDE (Sun angle = 60°).

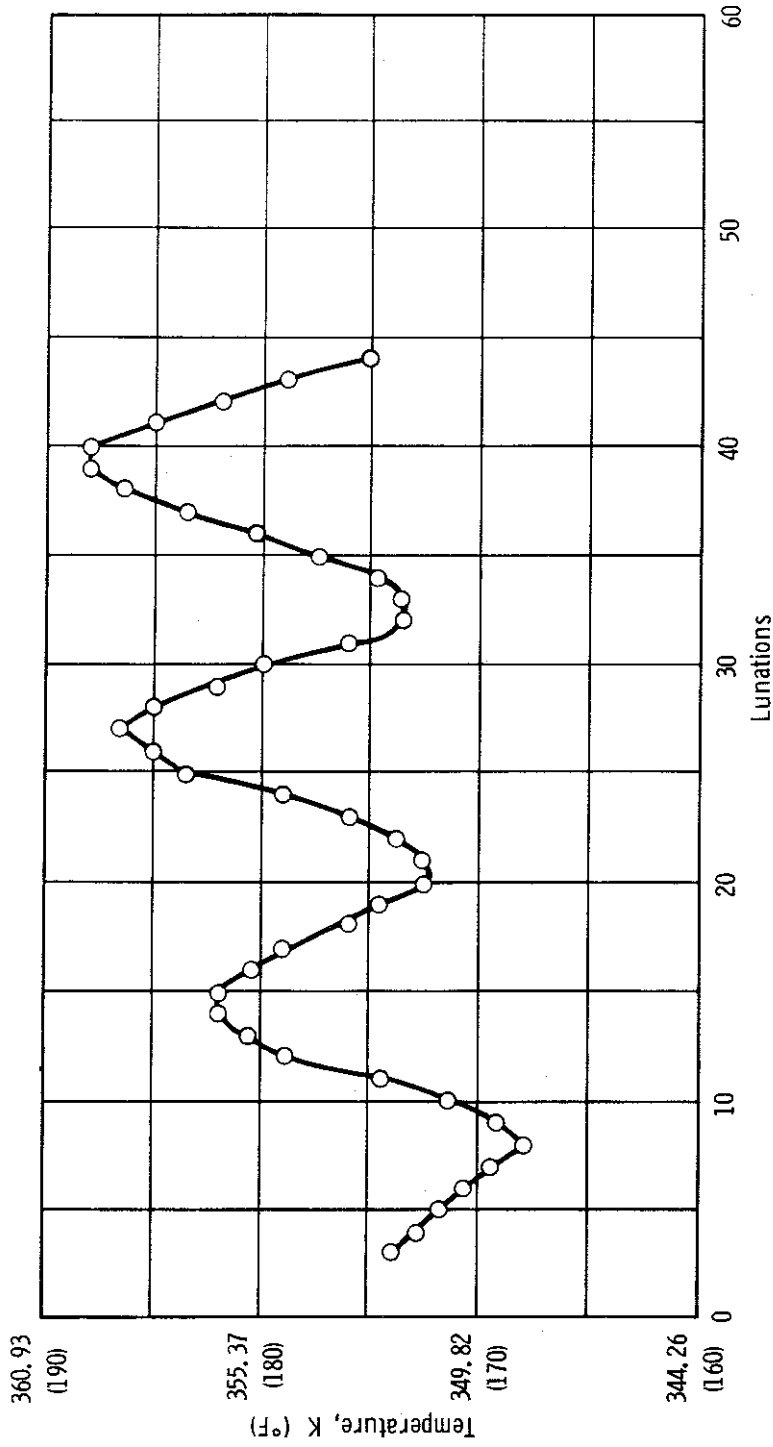

Figure 7-11.- Temperature profile for Apollo 17 LEAM (Sun angle = 60°).

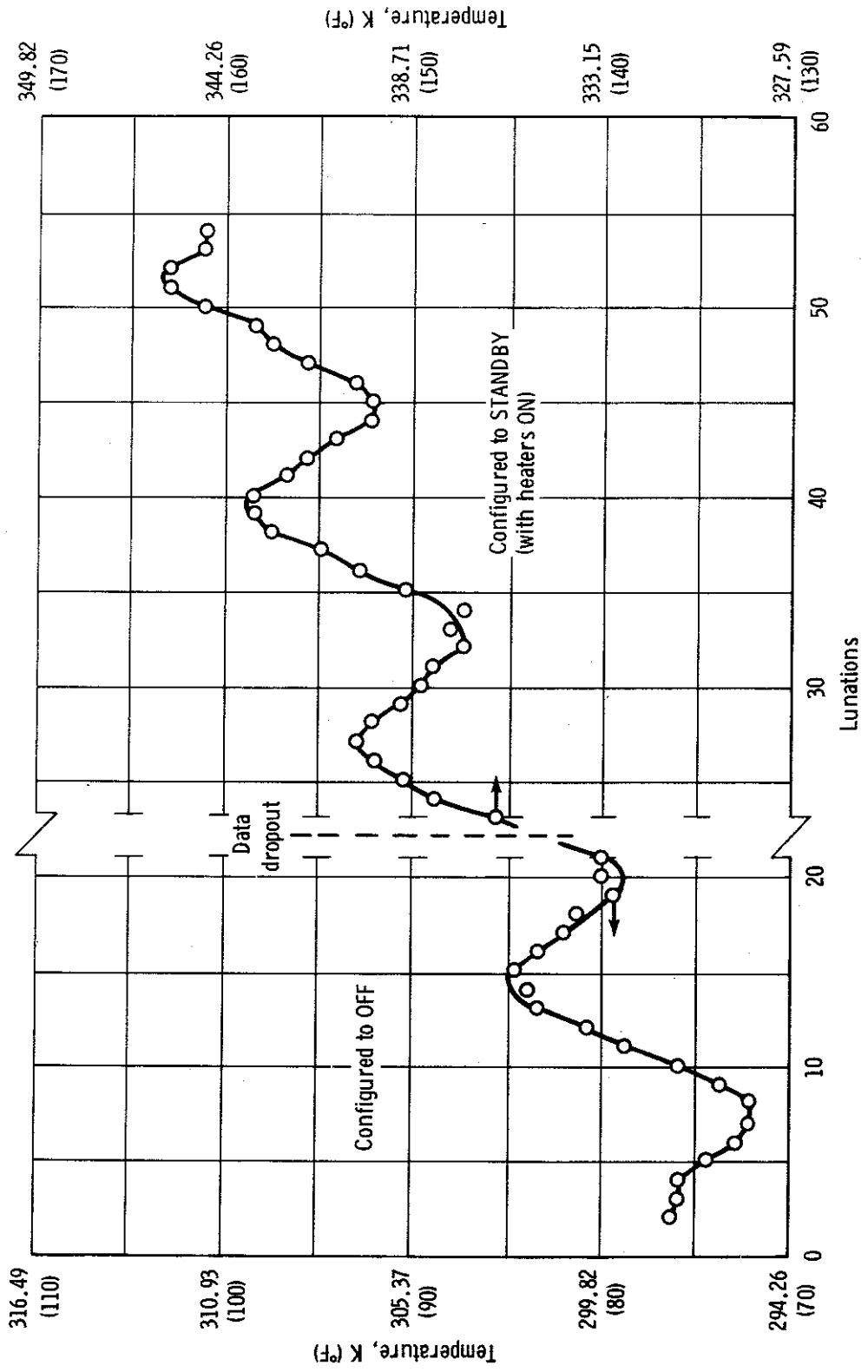

Figure 7-12.- Temperature profile for Apollo 17 LMS (Sun angle = 90°).

8. RECOMMENDATIONS

The Apollo Lunar Surface Experiments Package (ALSEP) ushered in a new era of scientific study and exploration from remote sites in space. It also resulted in new experiences in the receiving and processing of data during each mission, during a period of prolonged data acquisition and processing after each mission, and during a period characterized by major technological changes. The following recommendations are those of the actual ALSEP operators who were involved in more than 8 years of continuous ALSEP operation.

1. Continuity of personnel should be maintained to the highest degree possible.
2. Changes in the support systems (both hardware and software) should be limited to an absolute minimum.
3. Periodic data collection (both engineering and science) should be maintained for the duration of a mission. The interval for ALSEP that provided an adequate data base was a "data cut" every 2 hours (1° of Sun angle) for a full lunation, then a "data cut" every 24 hours for the remainder of the mission. Each year, the 2-hour "data cut" interval should be repeated. The data should be the hardcopy type, one that does not fade and is easy to handle. These features were provided satisfactorily by the high-speed printer used for ALSEP.
4. The capability should be provided for storing data on a computer input/output device (magtape, drum, etc.); thus providing rapid access. All data should be source and time tagged.
5. During deployment of an experiment, the equipment should be emplaced as far as possible from interfering sources. Examples are as follows: The lunar module (LM) descent stage generated a great deal of noise that interfered with the Passive Seismic Experiments. Also, outgassings from the LM, from the crew's extra vehicular activity (EVA) packs, and from the ALSEP packing material interfered with particle measuring experiments for a long period of time.

9. BIBLIOGRAPHY

- Bendix Corporation: Bendix Technical Journal, vol. 4, Summer-Autumn 1971.
- Bendix Corporation: Apollo 16 ALSEP Array D Flight System Familiarization Manual. NASA CR-128924, 1971.
- Bendix Corporation: Apollo Lunar Surface Experiments Package (Monthly Progress Report). NASA CR-115455, 1972.
- Bendix Corporation: Apollo Lunar Surface Experiments Package (Monthly Progress Report). NASA CR-115577, 1972.
- Bendix Corporation: Apollo Lunar Surface Experiments Package (Monthly Progress Report). NASA CR-115738, 1972.
- Bendix Corporation: Apollo Lunar Surface Experiments Package (Monthly Progress Report). NASA CR-115739, 1972.
- Bendix Corporation: Apollo Lunar Surface Experiments Package (Monthly Progress Report). NASA CR-128580, 1972.
- Bendix Corporation: Apollo Lunar Surface Experiments Package (Monthly Progress Report). NASA CR-128597, 1972.
- Bendix Corporation: Apollo Lunar Surface Experiments Package. Apollo 17 ALSEP (Array E) Familiarization Course Handout. NASA CR-128636, 1972.
- Bendix Corporation: ALSEP Arrays A, B, C, and A-2. Lunar Surface Exploration Instrument Specifications (Final Report). NASA CR-134202, 1973.
- Berg, O. E.; Richardson, F. F.; Auer, S.; and Rhee, J. W.: Preliminary Results of a Cosmic Dust Experiment on the Moon. Geophys. Res. Letters, vol. 1, Nov. 1974, pp. 289-290.
- Chute, J., Jr.; Clark, S. P.; et al.: Apollo 13 Lunar Heat Flow Experiment. Science, vol. 168, 1970, pp. 211-217.
- Dorman, J.; Duennebier, F.; et al.: Seismic Data From Man-Made Impacts on the Moon. Science, vol. 170, 1970, pp. 620-626.
- Dyal, P.; Parkin, C. W.; and Sonett, C. P.: Lunar Surface Magnetometer. IEEE Transactions on Geoscience Electronics, vol. GE-8, 1970, pp. 203-215.

- Dyal, P.; Parkin, C. W.; and Cassen, P.: Surface Magnetometer Experiments - Internal Lunar Properties and Lunar Field Interactions With the Solar Plasma. Lunar Science Conference, 3rd, Houston, Tex., January 10 to 13, 1972, Proceedings, vol. 3, MIT Press (Cambridge, Mass.), 1972, pp. 2287-2307.
- Dyal, P.; and Gordon, D. I.: Lunar Surface Magnetometers. (Institute of Electrical and Electronics Engineers, Intermag Conference, Washington, D.C., Apr. 24 to 27, 1973.) IEEE Transactions on Magnetics, vol. Mag-9, Sept. 1973, pp. 226-231.
- Dyal, P.; Parkin, C. W.; and Daily, W. D.: Surface Magnetometer Experiments. Internal Lunar Properties. NASA TM X-62278, 1973.
- Eason, R. L.: Apollo Experience Report, Apollo Lunar Surface Experiments Package Data Processing System. NASA TN D-7781, 1974.
- Eichelman, W. F.; Lauderdale, W. W.: Apollo Scientific Experiments Data Handbook. NASA TM X-58131, 1974.
- Freeman, J. W., Jr.: Energetic Ion Bursts on the Nightside of the Moon. J. Geophys. Res., vol. 77, Jan. 1, 1972, pp. 239-243.
- Freeman, J. W., Jr.: Suprathermal Ion Detector Results From Apollo Missions. Paper presented at COSPAR, Plenary Meeting, 15th, Madrid, Spain, May 10 to 24, 1972.
- Freeman, J. W., Jr.; Fenner, M. A.; et al.: Suprathermal Ions Near the Moon. (International Union of Geophysics and Geodesy, General Assembly, 15th, Moscow State University, Moscow, USSR, July 30 to Aug. 14, 1971.) Icarus, vol. 16, Apr. 1972, pp. 328-338.
- Freeman, J. W., Jr.; Hills, H. K.; and Vondrak, R. R.: Water Vapor, Whence Comest Thou. Lunar Science Conference, 3rd, Houston, Tex., January 10 to 13, 1972, Proceedings, vol. 3, MIT Press (Cambridge, Mass.), 1972, pp. 2217-2230.
- Freeman, J. W., Jr.; Fenner, M. A.; and Hills, H. K.: Electric Potential of the Moon in the Solar Wind. J. Geophys. Res., vol. 78, Aug. 1, 1973, pp. 4560-4567.
- Freeman, J. W., Jr.; Fenner, M. A.; and Hills, H. K.: The Electric Potential of the Moon in the Solar Wind. Photon and Particle Interactions With Surfaces in Space; Proceedings of the Sixth ESLAB Symposium, Noordwijk, Netherlands, Sept. 26 to 29, 1972. D. Reidel Publishing Co., 1973, pp. 363-368; Discussion, p. 368.
- Freeman, J. W., Jr.; Hills, H. K.; Lindeman, R. A.; and Vondrak, R. R.: Observations of Water Vapor Ions at the Lunar Surface. The Moon, vol. 8, July-Aug. 1973, pp. 115-128.

- Freeman, J. W.; and Ibrahim, M.: Lunar Electric Fields, Surface Potential and Associated Plasma Sheaths. Lunar Science Institute, Conference on Interactions of the Interplanetary Plasma With the Modern and Ancient Moon, Lake Geneva, Wis., Sept. 30 to Oct. 4, 1974. *The Moon*, vol. 14, Sept. 1975, pp. 103-114.
- Goldstein, B. E.: Observations of Electrons at the Lunar Surface. *J. Geophys. Res.*, vol. 79, Jan. 1, 1974, pp. 23-35.
- Harris, R. S., Jr.: Apollo Experience Report, Thermal Design of Apollo Lunar Surface Experiments Package. NASA TN D-6738, 1972.
- Hinners, N. W.; and Mason, P. V.: The Apollo 17 Surface Experiments. *Astronaut. & Aeronaut.*, vol. 10, Dec. 1972, pp. 40-54.
- Hoffman, J. H.; and Hodges, R. R., Jr.: Molecular Gas Species in the Lunar Atmosphere. Lunar Science Institute, Conference on Interactions of the Interplanetary Plasma With the Modern and Ancient Moon, Lake Geneva, Wis., Sept. 30 to Oct. 4, 1974. *The Moon*, vol. 14, Sept. 1975, pp. 159-167.
- Johnson, F. S.; Carroll, J. M.; and Evans, D. E.: Vacuum Measurements on the Lunar Surface. (International Vacuum Congress, 5th, Boston, Mass., Oct. 11 to 15, 1971.) *J. Vac. Sci. & Tech.*, vol. 9, Jan.-Feb. 1972, pp. 450-456.
- Keihm, S. J.; Peters, K.; Langseth, M. G.; and Chute, J. L., Jr.: Apollo 15 Measurement of Lunar Surface Brightness Temperatures - Thermal Conductivity of the Upper 1.5 Meters of Regolith. *Earth Planet. Sci. Letters*, vol. 19, no. 3, July 1973, pp. 337-351.
- Lammlein, D. R.; Latham, G. V.; et al.: Lunar Seismicity, Structure, and Tectonics. *Rev. Geophys. Space Phys.*, vol. 12, Feb. 1974, pp. 1-21.
- Langseth, M. G., Jr.; Drake, E. M.; Nathanson, D.; Fountain, J. A.: Development of an In Situ Thermal Conductivity Measurement for the Lunar Heat Flow Experiment. *Thermal Characteristics of the Moon*. MIT Press, (Cambridge, Mass.), 1972, pp. 169-204.
- Latham, G. V.: Lunar Seismology. *EOS*, vol. 52, 1971, pp. IUGG 162-IUGG 165.
- Manka, R. H.; and Michel, F. C.: Lunar Ion Flux and Energy. Photon and Particle Interactions With Surfaces in Space; Proceedings of the Sixth ESLAB Symposium, Noordwijk, Netherlands, Sept. 26 to 29, 1972. D. Reidel Publishing Co., 1973, pp. 429-441; Discussion, pp. 441 and 442.
- Mark, N.; and Sutton, G. H.: Lunar Shear Velocity Structure at Apollo Sites 12, 14, and 15. *J. Geophys. Res.*, vol. 80, Dec. 10, 1975, pp. 4932-4938.

Medrano, R. A.; Freeman, J. W., Jr.; Vondrak, R. R.; and Hills, H. H.: Observation of a Driver Gas-Tangential Discontinuity. International Symposium on Solar-Terrestrial Physics, Sao Paulo, Brazil, June 17 to 22, 1974, Proceedings, vol. 1, Sao Jose Dos Campos, Brazil, Instituto de Pesquisas Espaciais, 1974, pp. 204-218.

National Aeronautics and Space Administration: Apollo 11 Preliminary Science Report. NASA SP-214, 1969.

National Aeronautics and Space Administration: Apollo 12 Preliminary Science Report. NASA SP-235, 1970.

National Aeronautics and Space Administration: Apollo 14 Preliminary Science Report. NASA SP-272, 1971.

National Aeronautics and Space Administration: Apollo 15 Mission Report. NASA TM X-68394, 1971.

National Aeronautics and Space Administration: Apollo 15 Preliminary Science Report. NASA SP-289, 1972.

National Aeronautics and Space Administration: Apollo 16 Preliminary Science Report. NASA SP-315, 1972.

National Aeronautics and Space Administration: Apollo 17 Preliminary Science Report. NASA SP-330, 1973.

Nelms, W. L.; and Schwartz, W.: Mechanical Aspects of the Lunar Surface Magnetometer. Aerospace Mechanisms, Part A - General Applications, G. G. Herzl, ed., vol. I, pp. 463-468.

Neugebauer, M.; Snyder, C. W.; Clay, D. R.; and Goldstein, B. E.: Solar Wind Observations on the Lunar Surface With the Apollo-12 ALSEP. Planet. & Space Sci., vol. 20, Oct. 1972, pp. 1577-1591.

Orsag, J. W.; and Vogt, R. A.: Cold-Cathode-Gage Experiment Electronics Package. Thermal Shield Design Development. NASA TM X-72057, 1968.

Prosser, D. L.: SNAP-27 on the Moon. Isotopes & Radiation Technology, vol. 7, 1970, pp. 443-447.

Reasoner, D. L.; and Burke, W. J.: Characteristics of the Lunar Photoelectron Layer in the Geomagnetic Tail. J. Geophys. Res., vol. 77, Dec. 1, 1972, pp. 6671-6687.

Reasoner, D. L.; and Burke, W. J.: Direct Observation of the Lunar Photoelectron Layer. Lunar Science Conference, 3rd, Houston, Tex., January 10 to 13, 1972, Proceedings, vol. 3, MIT Press, (Cambridge, Mass.), 1972, pp. 2639-2654.

- Reasoner, D. L.; and Burke, W. J.: Measurement of the Lunar Photoelectron Layer in the Geomagnetic Tail. Photon and Particle Interactions With Surfaces in Space; Proceedings of the Sixth ESLAB Symposium, Noordwijk, Netherlands, Sept. 26 to 29, 1972. D. Reidel Publishing Co., 1973, pp. 369-386; Discussion, pp. 386 and 387.
- Remini, W. C.; and Grayson, J. H.: SNAP-27/ALSEP Power Subsystem Used in the Apollo Program. Energy 70; Proceedings of the Fifth Intersociety Energy Conversion Engineering Conference, Las Vegas, Nev., Sept. 21 to 25, 1970, vol. 2. Hinsdale, Ill., American Nuclear Society, 1972, pp. 13-10 to 13-15.
- Rhee, J. W.; Berg, O. E.; and Wolf, H.: Electrostatic Dust Transport and Apollo 16 LEAM Experiment. Space Research XVII; Proceedings of the Open Meetings of Working Groups on Physical Sciences, June 8 to 19, 1976, and Symposium on Minor Constituents and Excited Species, Philadelphia, Pa., June 9 and 10, 1976. Pergamon Press, 1977, pp. 627-629.
- Rice University: The Apollo Lunar Surface Experiment Package Suprathermal Ion Detector Experiment - Bibliographies (Final Report). NASA CR-144544, 1975.
- Schneider, H. E.; and Freeman, J. W.: Energetic Lunar Nighttime Ion Events. Lunar Science Institute, Conference on Interactions of the Interplanetary Plasma With the Modern and Ancient Moon, Lake Geneva, Wis., Sept. 30 to Oct. 4, 1974. The Moon, vol. 14, Sept. 1975, pp. 27-33.
- Stanford University: Apollo 14 and 16 Active Seismic Experiments, and Apollo 17 Lunar Seismic Profiling (Final Report). NASA CR-147760, 1976.

APPENDIX A

LIST OF ACRONYMS

ALSEP	Apollo Lunar Surface Experiments Package
APM	automatic power management
ASE	Active Seismic Experiment or ALSEP Senior Engineer
BPI	bits per inch
CPLEE	Charged Particle Lunar Environment Experiment
DAC	digital-to-analog converter
DSS	data subsystem
DTREM	dust thermal radiation engineering measurement (dust detector)
EASEP	Early Apollo Scientific Experiment Package
EPS	electrical power subsystem
EUV	extreme ultraviolet
EVA	extra vehicular activity
FM	frequency modulation
GSFC	NASA Goddard Space Flight Center
HF	high frequency
HFE	Heat Flow Experiment
JPL	NASA Jet Propulsion Laboratory
JSC	NASA Lyndon B. Johnson Space Center
LEAM	lunar ejecta and meteorites
LM	lunar module
LMS	lunar mass spectrometer
LPX, LPY, LPZ	long period x-, y-, and z-axis components (refers to Passive Seismic Experiment)
LSG	lunar surface gravimeter
LSM	lunar surface magnetometer
LSPE	Lunar Seismic Profiling Experiment
MOD	module
MSFN	Manned Space Flight Network
MSFNOM	Manned Space Flight Network Operation Manager
NSSDC	National Space Science Data Center
PCU	power conditioning unit
PDR	power dissipation resistors
PDU	power distribution unit
PI	Principal Investigator
PSE	Passive Seismic Experiment
RF	radio frequency
RSDP	remote site data processor
RTG	radioisotope thermoelectric generator
SCAMA	switching, conferencing, and monitoring arrangement
SIDE	Suprathermal Ion Detector Experiment
SMEAR	SPAN mission evaluation action request

SODB	spacecraft operational data book
SPAN	spacecraft analysis
SWS	solar wind spectrometer
TTY	teletype
UT	universal time
VLBI	very long base interferometer

1 Report No RP-1036		2 Government Accession No		3 Recipient's Catalog No.	
4 Title and Subtitle ALSEP Termination Report				5 Report Date April 1979	
				6 Performing Organization Code	
7 Author(s) James R. Bates, Lyndon B. Johnson Space Center; W. W. Lauderdale, General Electric Co.; and Harold Kernaghan, Kentron International, Inc.				8 Performing Organization Report No S-480	
9 Performing Organization Name and Address Lyndon B. Johnson Space Center Houston, Texas 77058				10 Work Unit No. 914-40-73-01-72	
				11 Contract or Grant No	
12 Sponsoring Agency Name and Address National Aeronautics and Space Administration Washington, D.C. 20546				13 Type of Report and Period Covered Reference Publication	
				14 Sponsoring Agency Code	
15 Supplementary Notes					
16 Abstract This final report on the Apollo Lunar Surface Experiments Package (ALSEP) was prepared when support operations were terminated September 30, 1977, and NASA discontinued the receiving and processing of scientific data transmitted from equipment deployed on the lunar surface. The ALSEP experiments (Apollo 11 to Apollo 17) are described and pertinent operational history is given for each experiment. The ALSEP data processing and distribution are described together with an extensive discussion on archiving. Engineering closeout tests and results are given, and the status and configuration of the experiments at termination are documented. Significant science findings are summarized by selected investigators. Significant operational data and recommendations are also included.					
17 Key Words (Suggested by Author(s)) Lunar science ASTP Lunar exploration Space sciences Lunar environment Moon Apollo			18 Distribution Statement STAR Subject Category 88 (Space Sciences)		
19 Security Classif (of this report) Unclassified		20 Security Classif. (of this page) Unclassified		21 No of Pages 162	22 Price* \$6.75