

Common Coil Design for 20 T Operational Field

Ramesh Gupta, K. Amm, M. Anerella, J. Cozzolino, M. Kumar,
C. Runyan, BNL, and P. Ferracin, LBL



Acknowledgement

Work performed under MDP task force on the **design of a 20 T hybrid magnet and comparative analysis**. Excellent collaborative and productive relationship.

- Magnet Design Program (MDP) Task Force Members

- **LBNL**: P. Ferracin, G. Vallone, L. Garcia Fajardo, M. Juchno, D. Arbelaez, L. Brouwer
- **FNAL**: G. Ambrosio, E. Barzi, V. Kashikhin, V. Marinozzi, I. Novitski, A. Zlobin
- **NHMFL**: L. Cooley
- **BNL**: M. Anerella, J. Cozzolino, R. Gupta, B. Yahia, C. Runyan, F. Kurian, M. Kumar
- **OSU**: M. Sumption, M. Majoros

- Collaborators

- Etienne Rochepault (**CEA**)
- Jillien Stern (**TUFTS University**, Prof. Luisa Chiesa)
- Martins Araujo Douglas (**PSI**)

Content

- ❑ **Common coil geometry**
- ❑ **Special consideration for very high field (20 T) dipoles**
- ❑ **Magnetic designs of HTS/LTS hybrid 20 T dipole with ~15% operating margin and a good field quality**
- ❑ **Initial mechanical analysis**
- ❑ **Remaining tasks**
- ❑ **Summary**

Common Coil Design for the Collider Dipoles

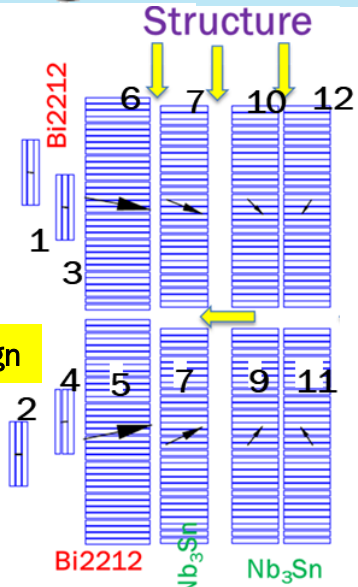
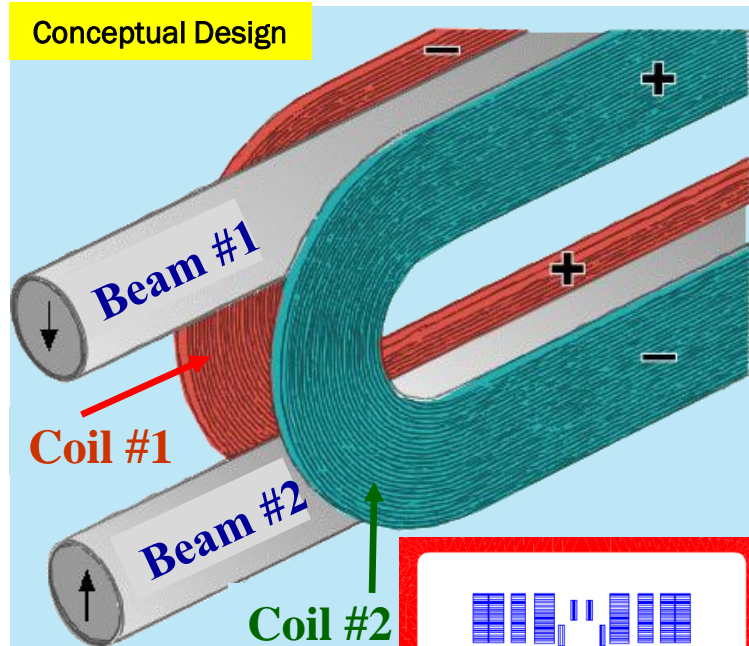
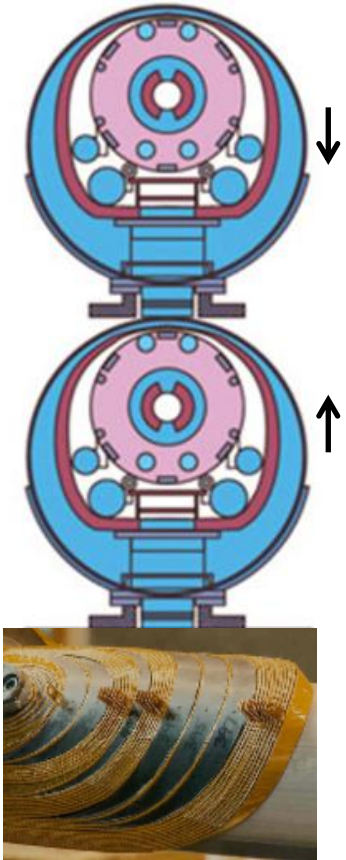

HTS/LTS 20 T Hybrid Design

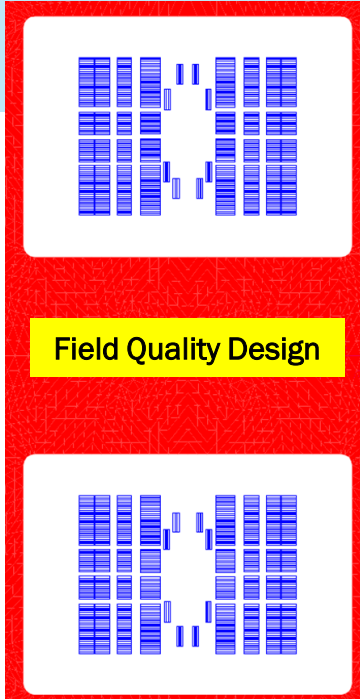

- **Simple 2-d geometry** for collider dipoles
- **Large bend radii**, determined by the spacing between the two apertures rather than the aperture itself
- **Allows** both “React & Wind” and “Wind & React” Technologies for Nb_3Sn /Bi2212
- **Allows** many ReBCO cables, including the new high current fusion cables
- **Uses less conductor** than in the other designs for 20^+ T dipoles (**surprise!!!**)
- **Easier & Efficient segmentation** between HTS/LTS coils for high field hybrid dipoles

Common Coil Design Uses Less Conductor than other designs for Very High Field Dipole

Stress Managed Cos θ

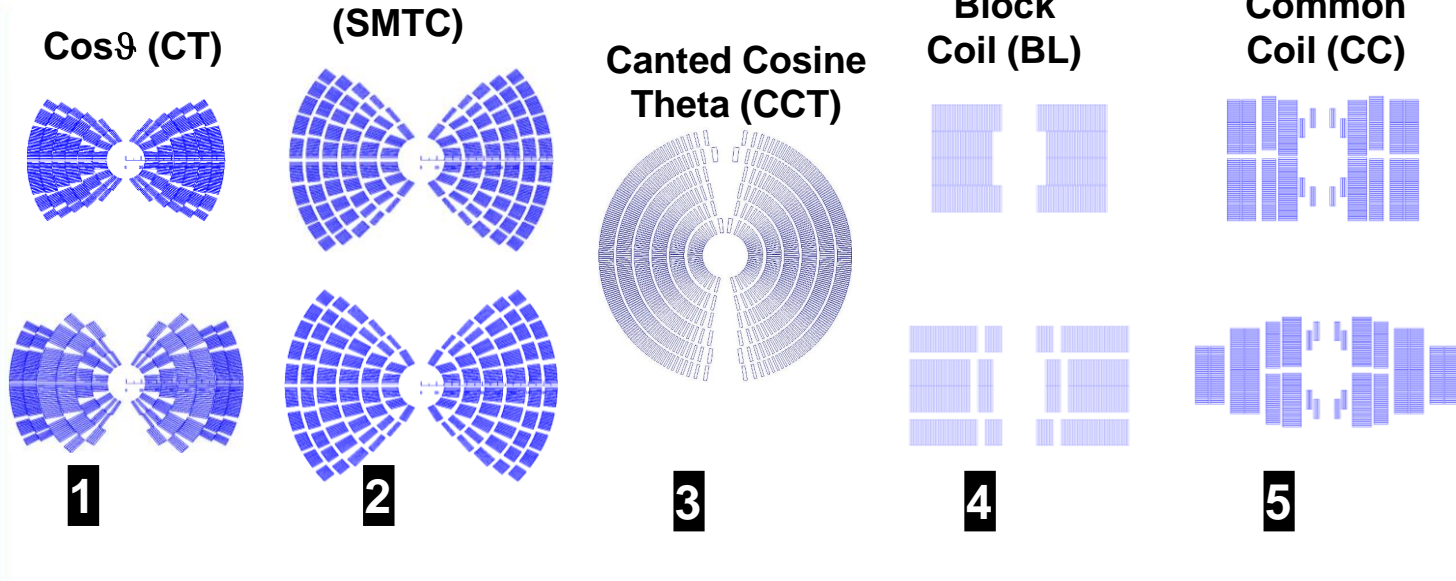

Conductor Usage in Various Designs

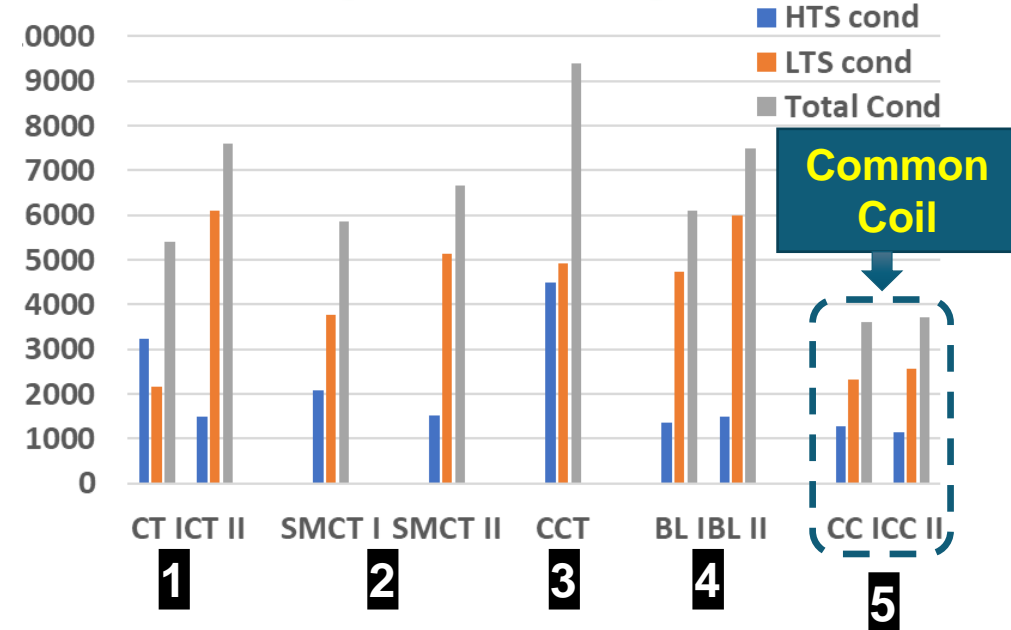

- Initial comparative study of various designs for 20 T dipole (as presented at MT) revealed that the common coil design used significantly less conductor than the other designs, well beyond what can be explained from small differences in margin, etc..
- That was a surprise, initially... Next slide: An explanation from the first principle.

In high field magnets, the ratio between the “Bore Area” and “Coil Area” becomes very large and things change...

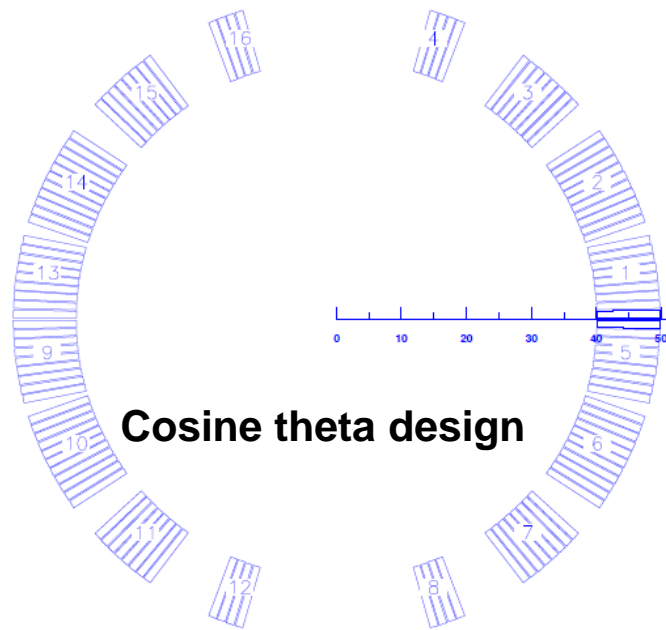

Low Field
(more conductor in block design)

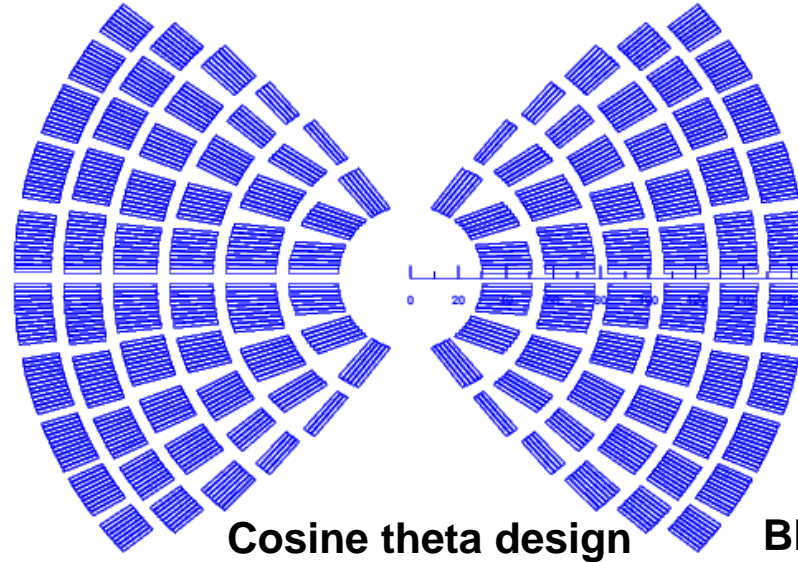

High Field
(less conductor in common coil)

Block coil design
(common coil)

Design less elegant →

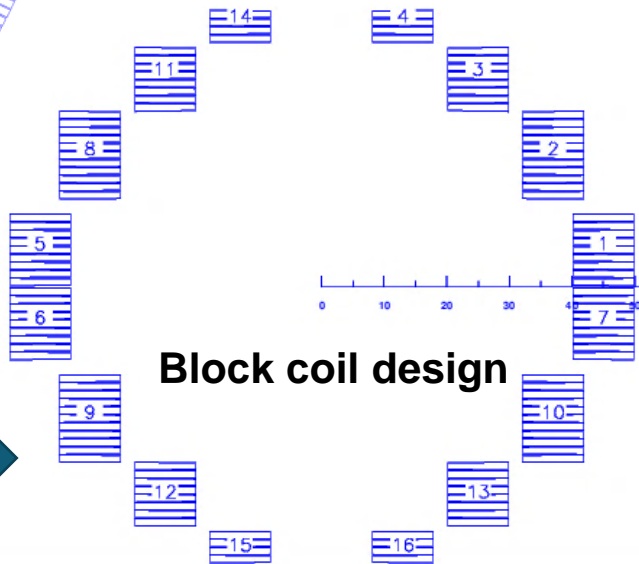

Design more elegant →

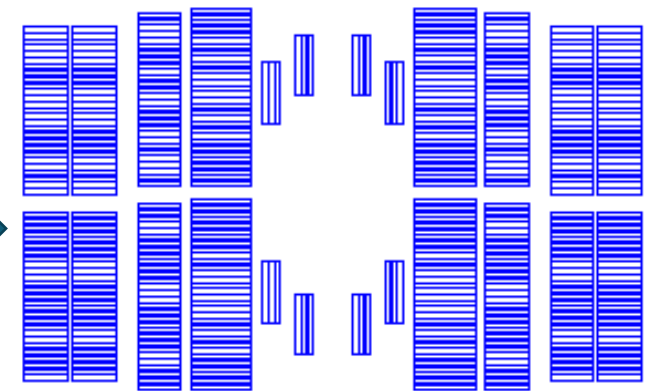

Magnetic Design of 20 T HTS/LTS Hybrid Dipoles (many interesting findings)

- All designs use the conductor as mentioned by P. Ferracin (previous talk)
- All designs have 50 mm clear bore and field harmonics <1 unit @15mm at 20 T
- All designs have ~15% operating margin over 20 T in both HTS and LTS coils
- All designs have HTS coils in series with the LTS coils

Flexibility in Design (all based on the same cables)

Initial Investigations found a major flexibility in the coil design. A significant variation in the coil width (i.e., number of layers: 4 to 6) to coil height product allowed for about the same conductor area (i.e., number of turns)

✓ Fewer layer (4-layer) design was chosen for the lower cost of manufacturing

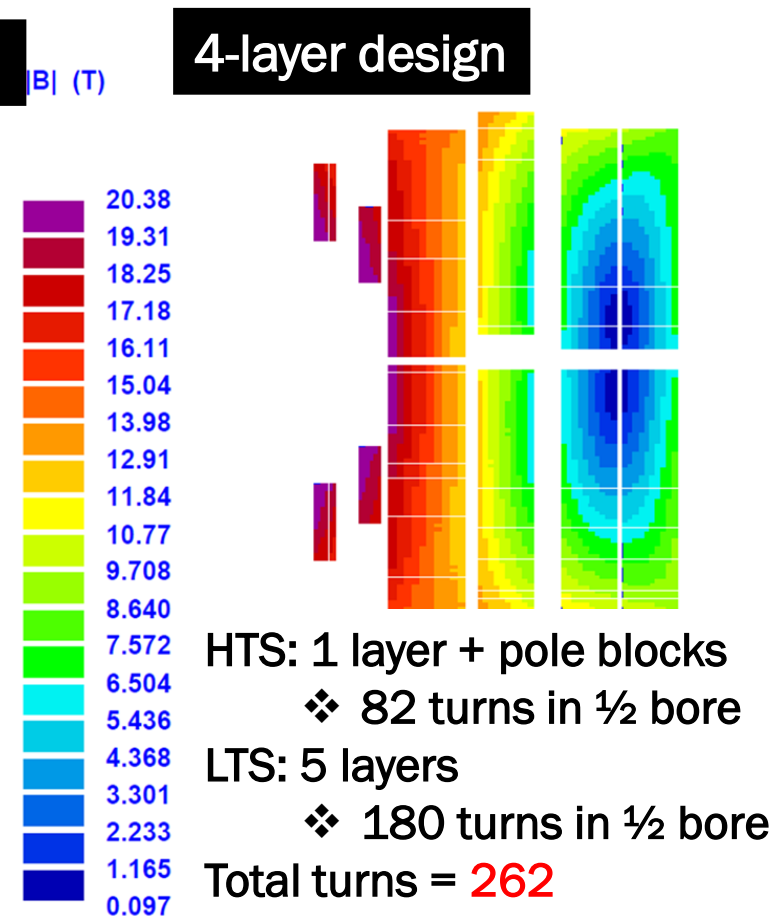
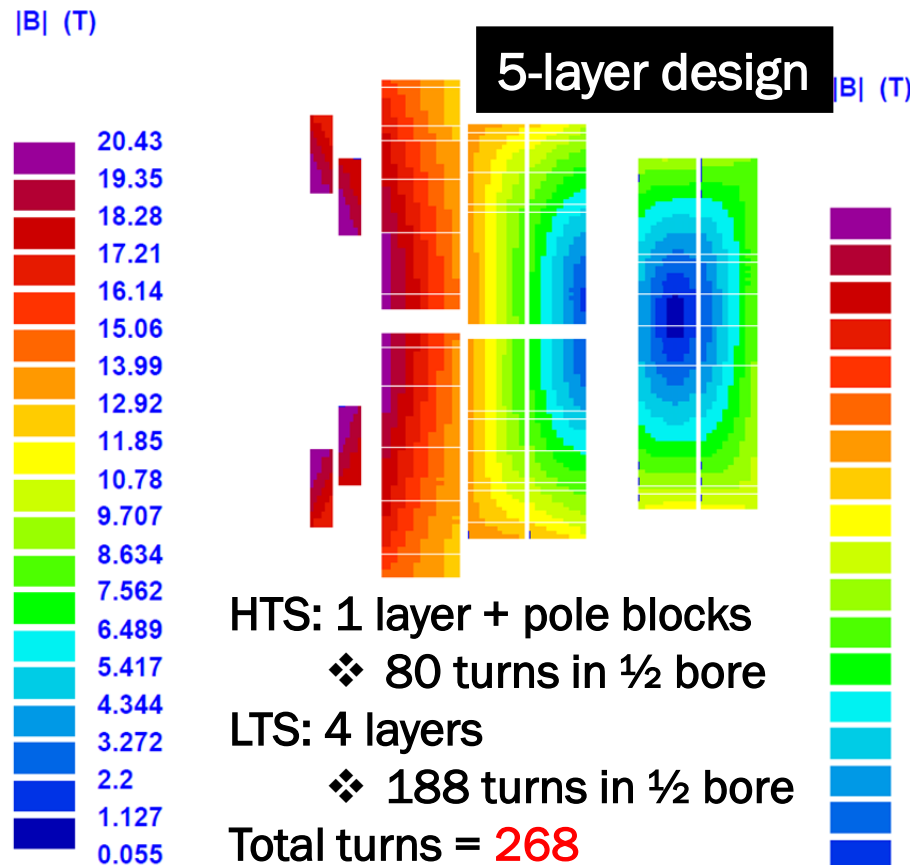
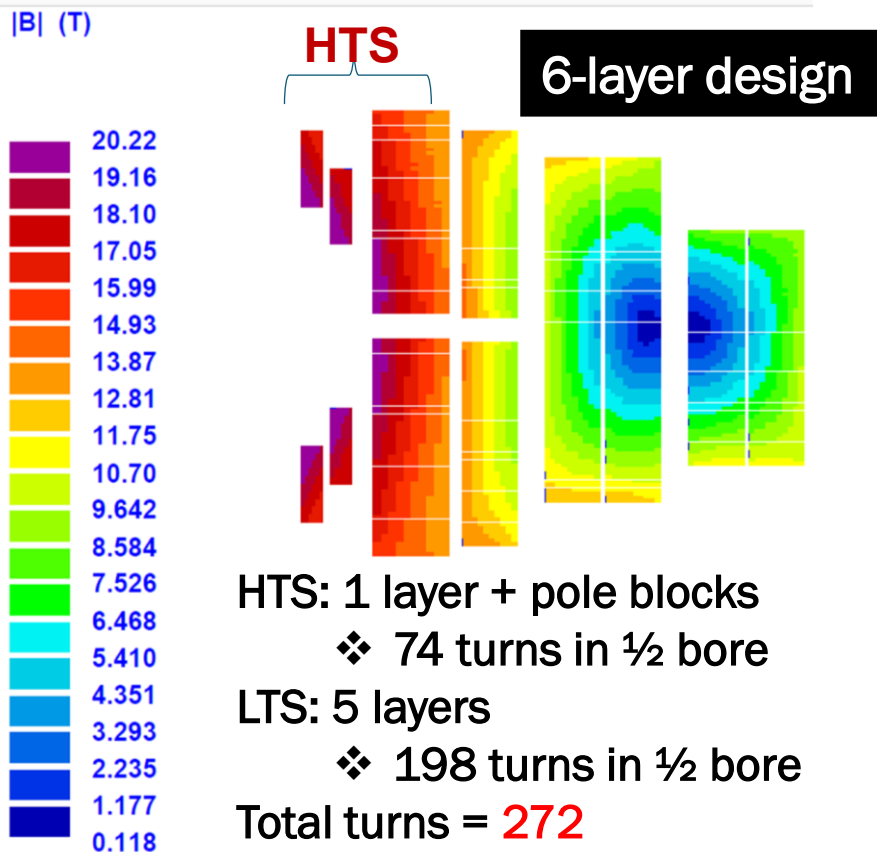

All Nb₃Sn Coils Could be Made Identical

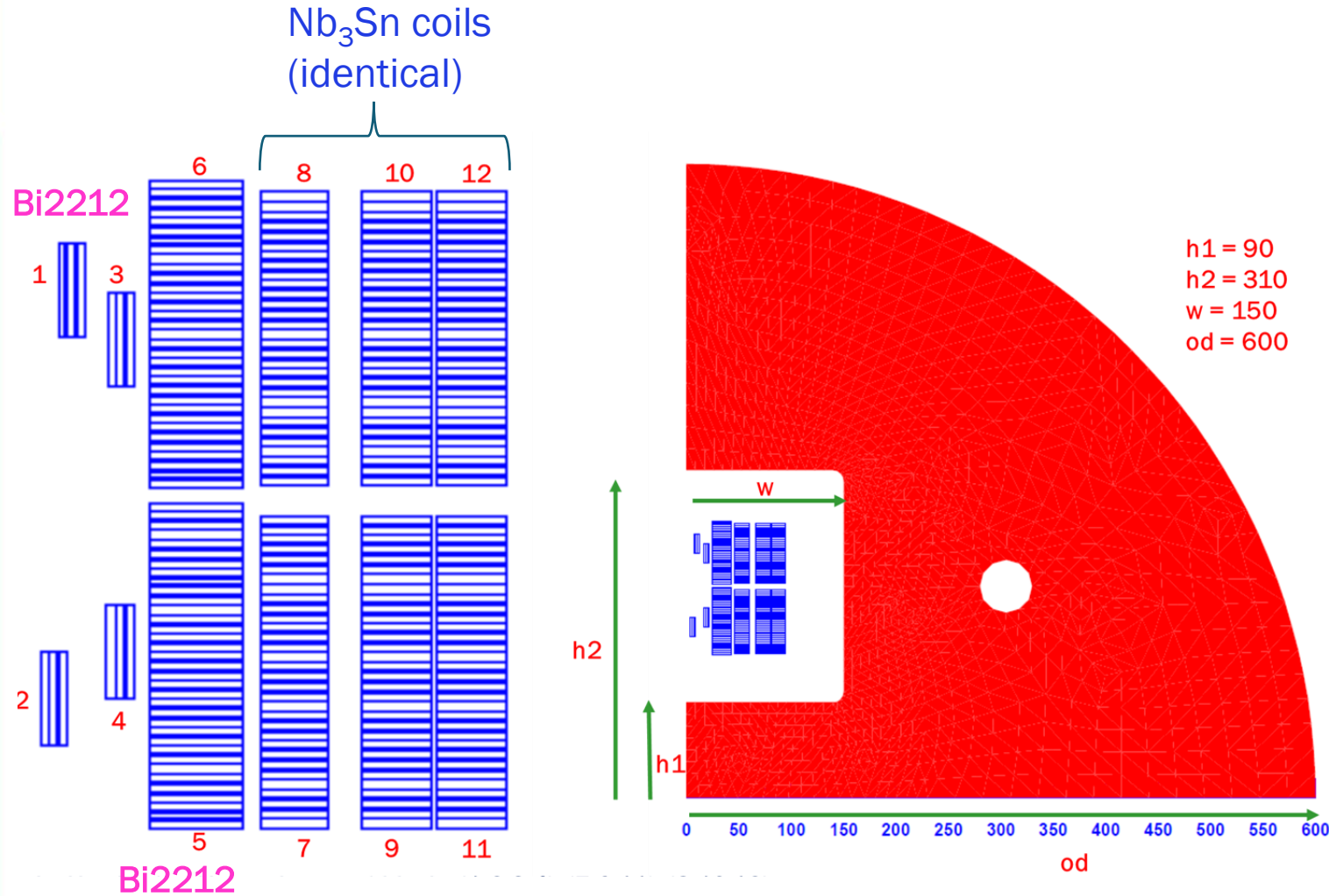

- All Nb₃Sn coils can be made identical. Meaning only one set for winding, reaction and impregnation tooling with a simple racetrack coil geometry.
- Need less practice & spare coils; can sort/switch coils between layers. These two offer significant savings.

Such prospects can't be imagined in the other designs

Magnetic Design of the 20 T HTS/LTS Common Coil Hybrid

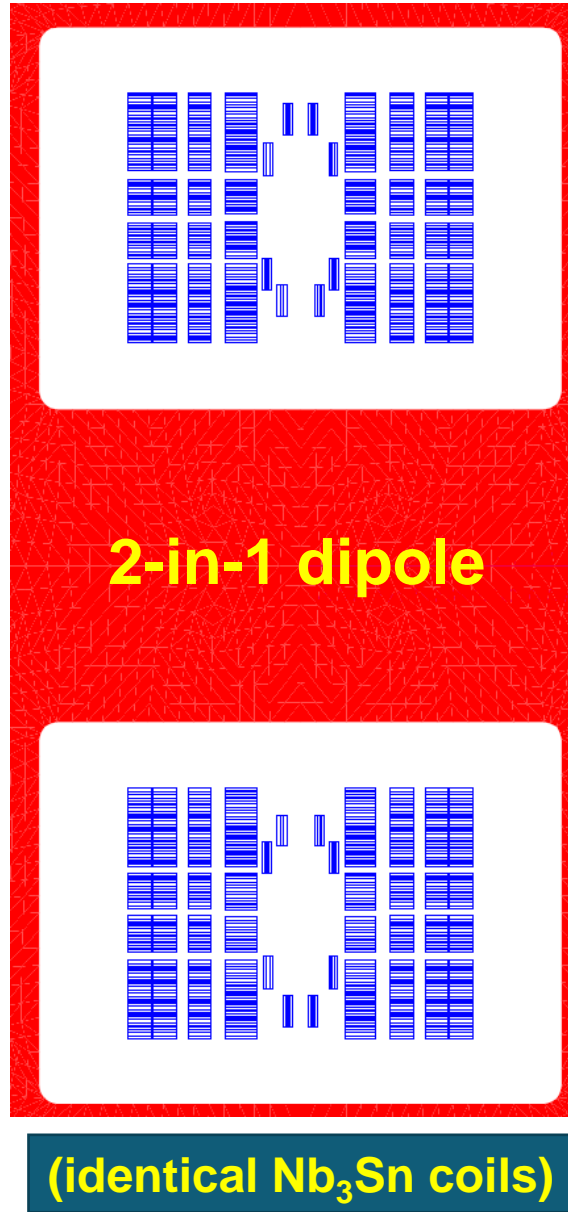
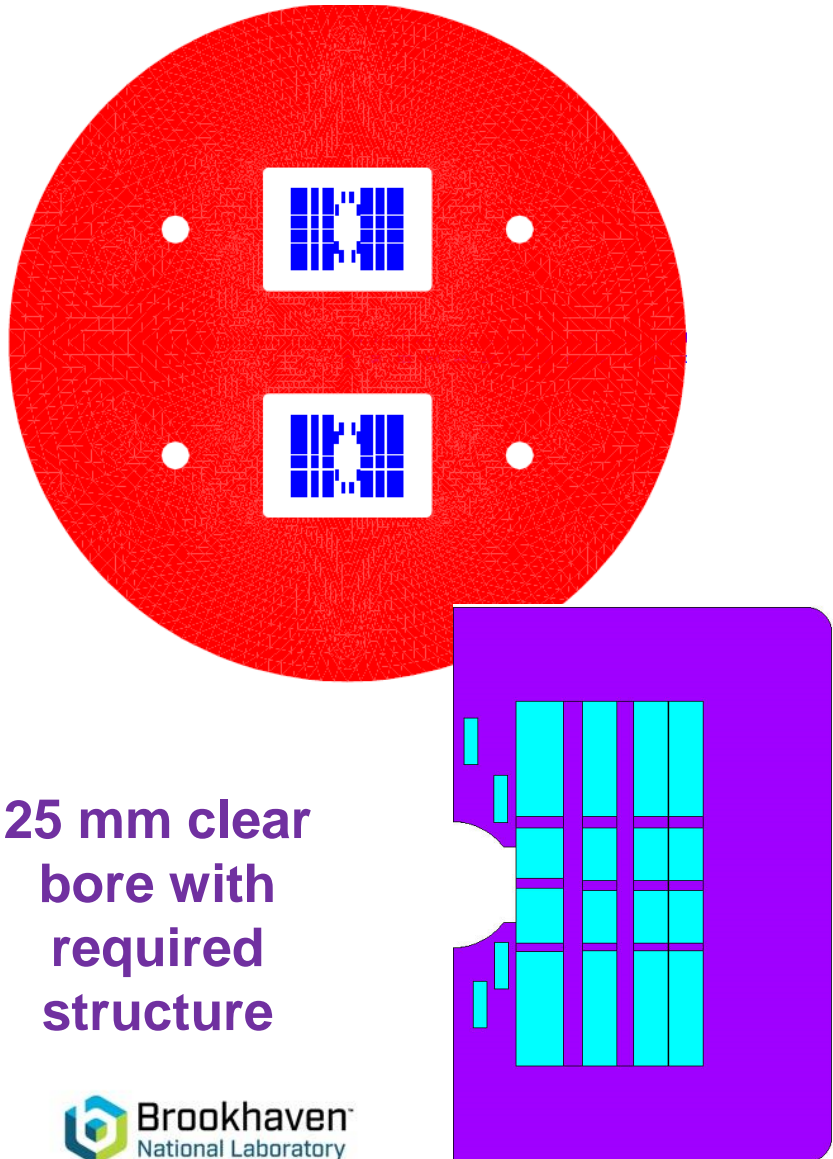

Efficient segmentation between HTS & LTS coils.
HTS coils only for one main coil (plus pole coils).

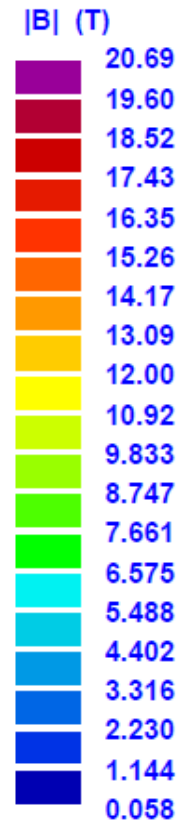

ROXIE¹⁰

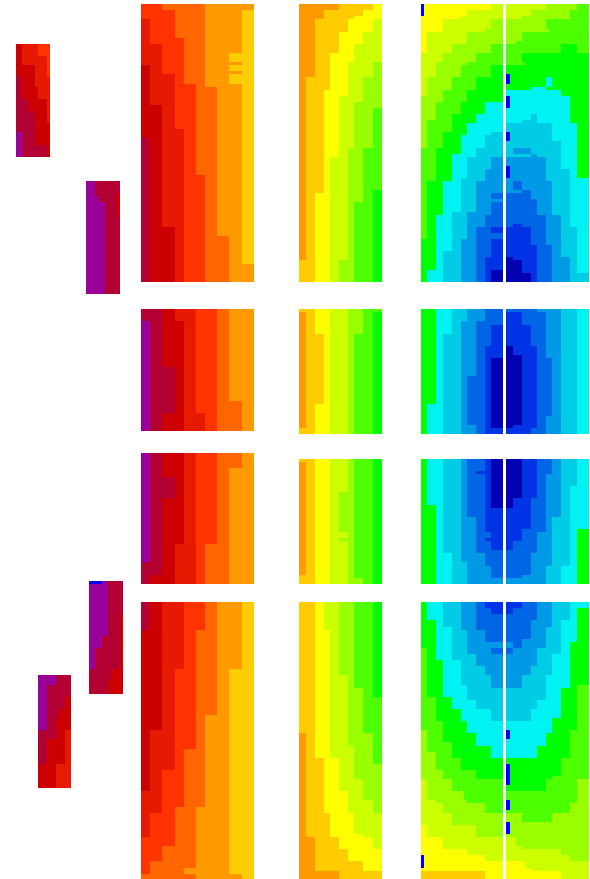

Well Matched Operating Margin Between LTS and HTS (15%)

	I(HTS), A	I(Nb3Sn)	Je(HTS), A/mm ²	Jo(HTS), A/mm ²	Je(Nb3Sn)	Jo(Nb3Sn)	Bo (T)	Bpk(HTS), T	Bpk(Nb3Sn)
	0	0	0	0	0	0	0	0	0
	13600	13600	487.60	400.672	639.10	526.316	19.938	20.695	13.670
1.0031	13642.2	13642.2	489.107	401.914	641.079	527.947	20.000	20.759	13.712
1.15355	15688.3	15688.3	562.465	462.195	737.231	607.132	23.000	23.873	15.769

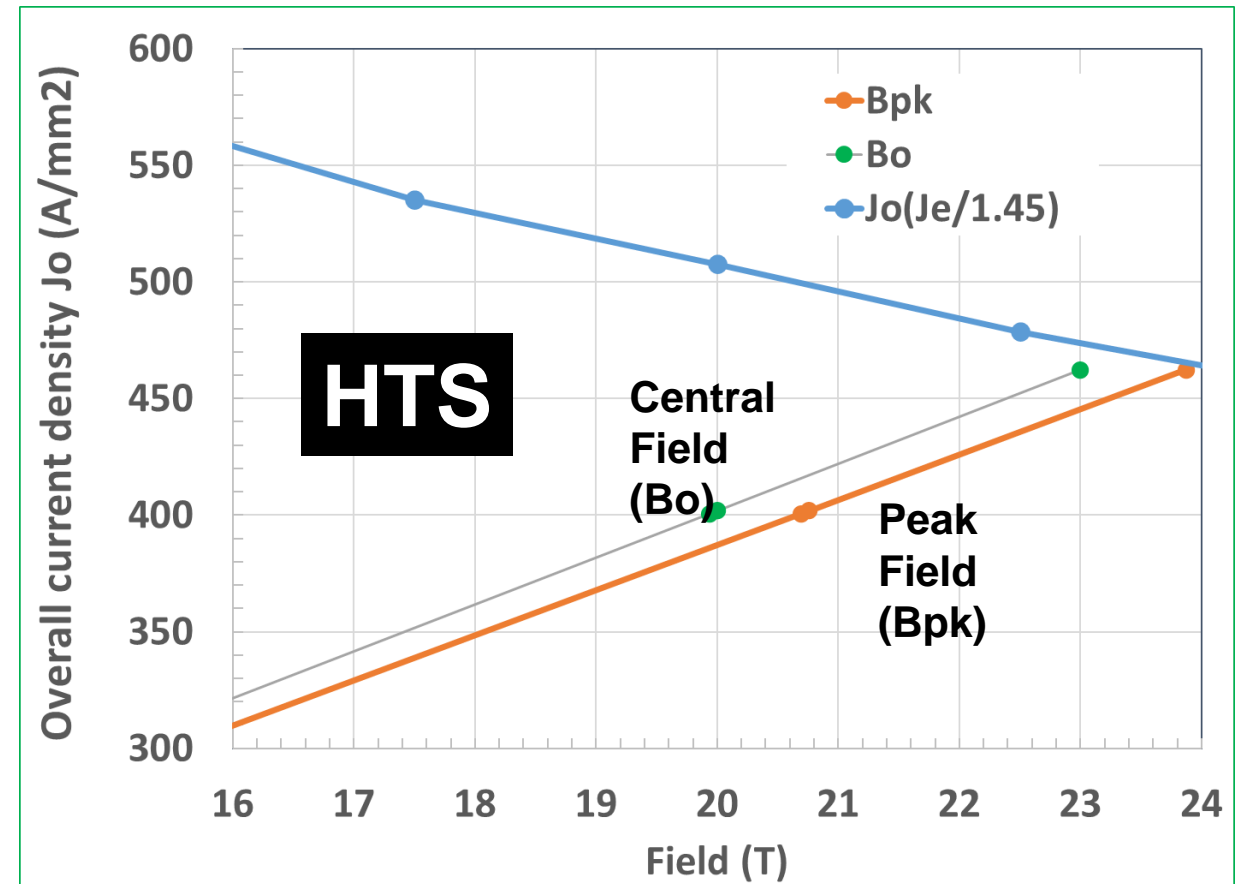
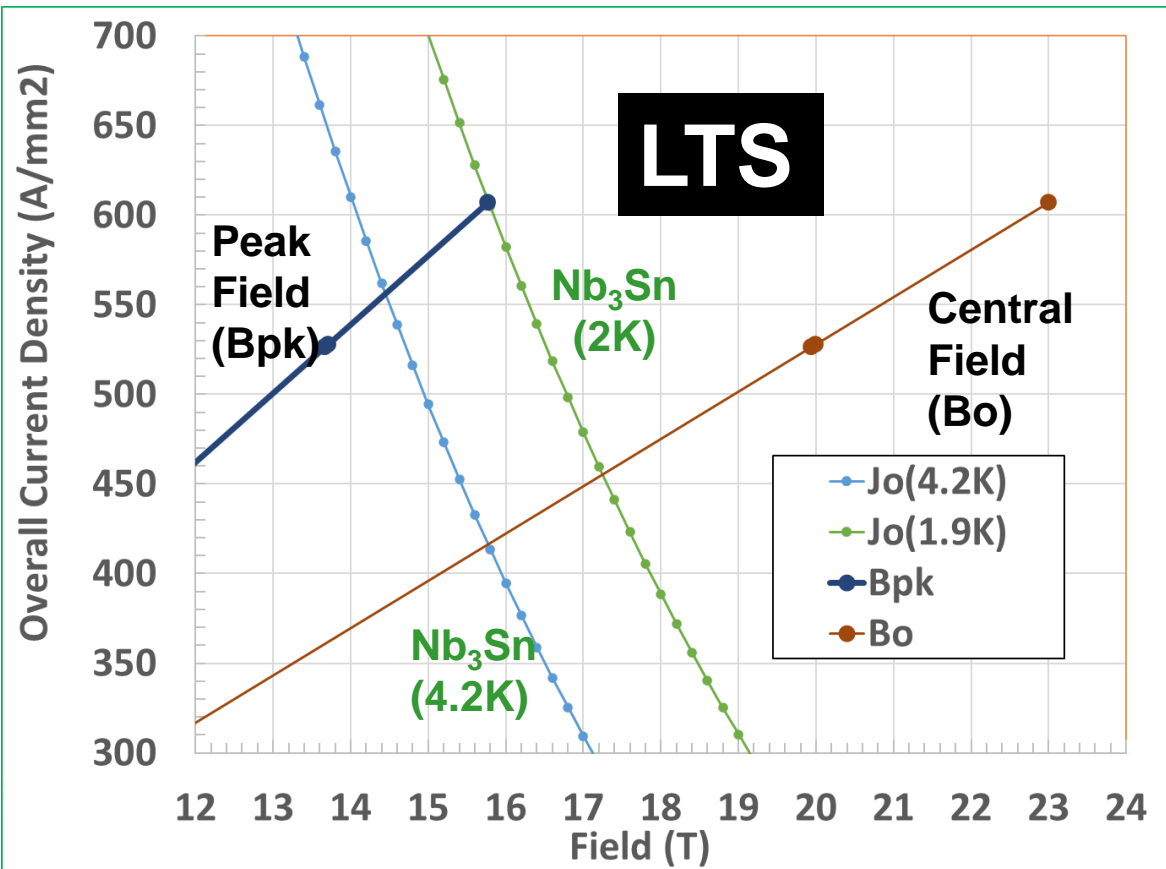

Good Geometric Field Quality (computed at 20 T)

MODEL	mdp_may2022-v2
BI2212R	Bi2212
Bare w	1.52
Bare h	18.35
Insulation	0.15
Ins w	1.82
Ins h	18.65
Ins Area	33.943
Current	13600
Je (A/mm ²)	487.60
Jo (A/mm ²)	400.67
Bpeak (T)	20.6951
MDPH2	Nb ₃ Sn
Bare w	1.6
Bare h	13.3
Insulation	0.15
Ins w	1.9
Ins h	13.6
Ins Area	25.840
Current	13600
Je (A/mm ²)	639.10
Jo (A/mm ²)	526.32
Bpeak (T)	13.6701
Bo	19.9382

NORMAL RELATIVE MULTIPOLES (1.D-4) :

b 1:	10000.00000	b 2:	-0.00000	b 3:	0.05059
b 4:	-0.00000	b 5:	0.09440	b 6:	0.00000
b 7:	-0.78244	b 8:	0.00000	b 9:	-0.92602
b10:	0.00000	b11:	-0.18313	b12:	-0.00000
b13:	-0.02800	b14:	0.00000	b15:	-0.01273
b16:	0.00000	b17:	-0.00410	b18:	-0.00000
b19:	-0.00094	b20:	0.00000	b	

All harmonics <1 unit

SKEW RELATIVE MULTIPOLES (1.D-4) :

a 1:	0.00000	a 2:	-0.00405	a 3:	0.00000
a 4:	-0.02333	a 5:	-0.00000	a 6:	-0.15914
a 7:	0.00000	a 8:	0.20675	a 9:	0.00000
a10:	0.08678	a11:	-0.00000	a12:	0.00779
a13:	0.00000	a14:	0.00593	a15:	-0.00000
a16:	0.00258	a17:	0.00000	a18:	0.00056
a19:	-0.00000	a20:	0.00019	a	

Reference radius: 15 mm

CORC[®] based 20 T Common Coil Design

➤ Common coil design allows higher J_e CORC due to large bend radii

❖ STTR with ACT anticipated a future common coil CORC with an engineering current density of 600 A/mm^2

- ❑ 800 A/mm^2 possible (STAR –Selva)
- ❑ Designs based on 600 A/mm^2 only

J_o for $J_e = 600 \text{ A/mm}^2$:

❑ $J_o = 600 * 28.3 / 52 = 326 \text{ A/mm}^2$

➤ Similar to Bi2212; but with a structure

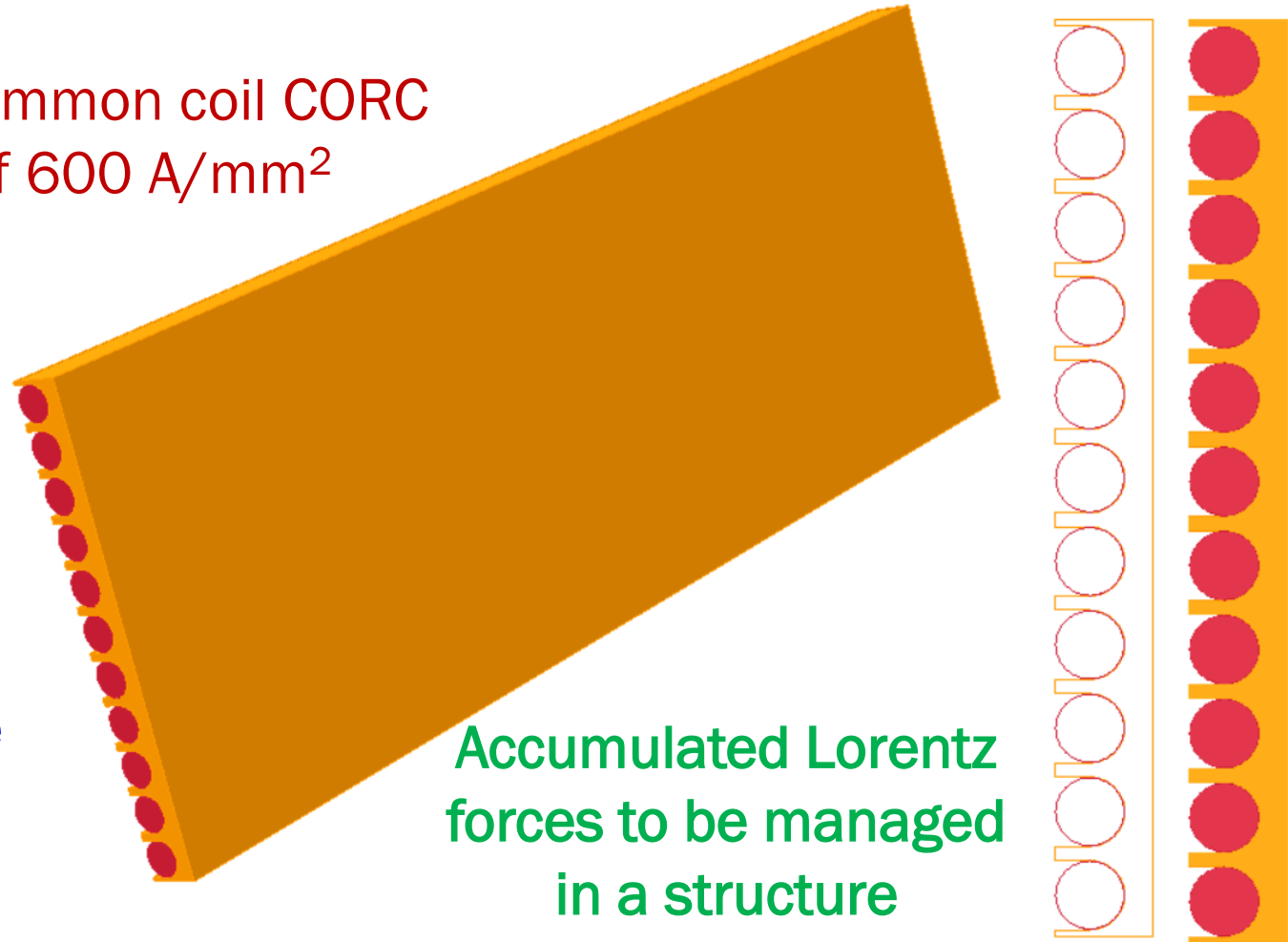

Initial Mechanical Analysis

Lorentz Forces in the Common Coil Geometry

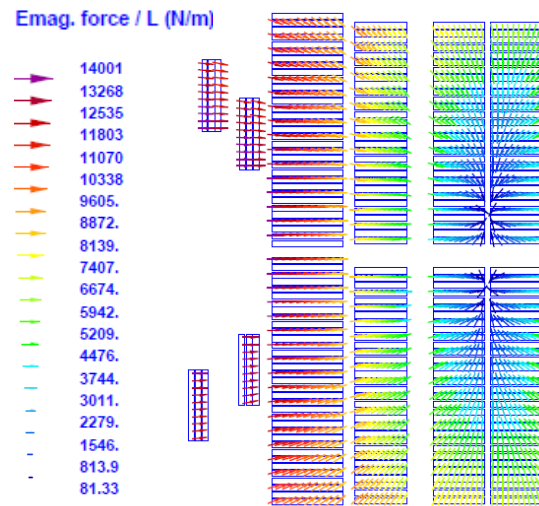
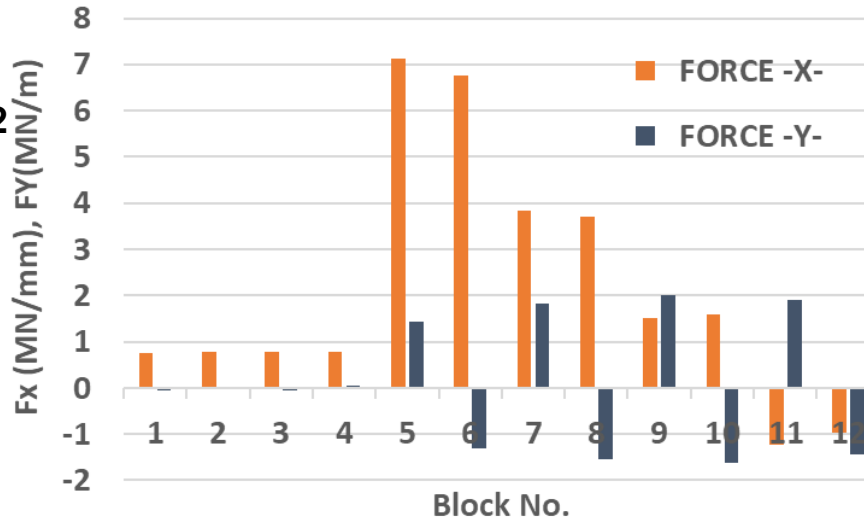
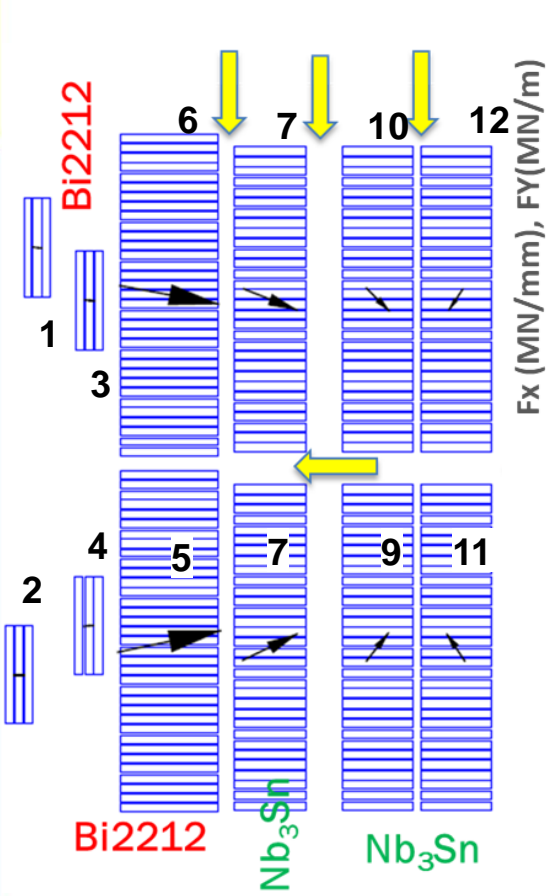

Concept of Stress-managed structure

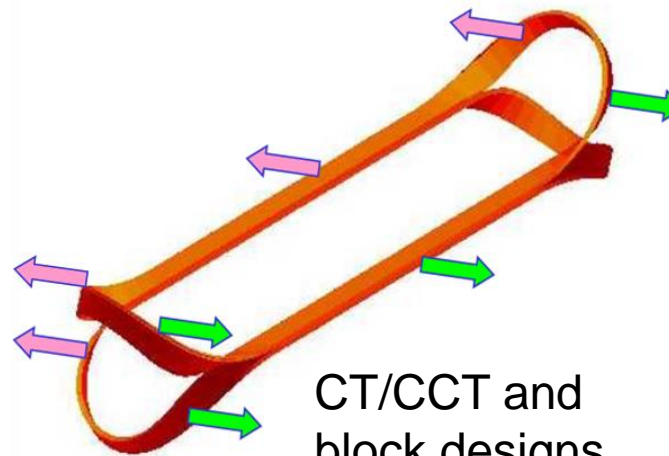

CT/CCT and block designs

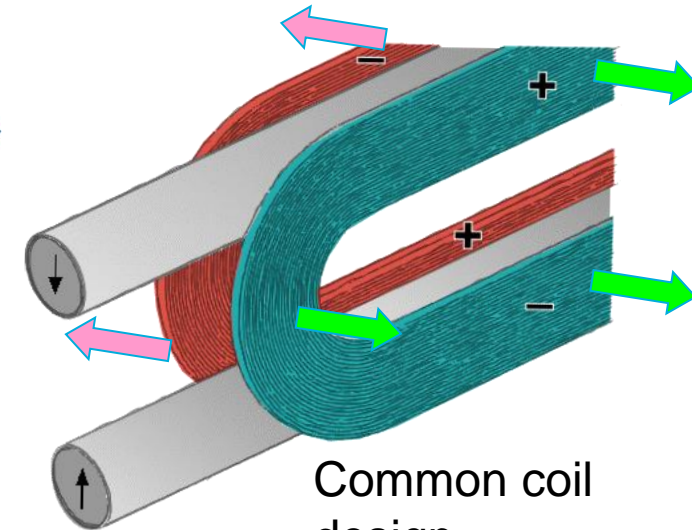

Common coil design

- Vertical forces much smaller than horizontal (maximum vertical is 1/3 of Max. horizontal)
- Since coils move as a unit in the common coil design, this motion doesn't create strain in the coil ends. Therefore, a larger horizontal movements can be tolerated. This is very different from the other designs.
- BNL common coil had 200 μm horizontal deflections and low vertical pre-stress
- Small forces on pole (mostly horizontal)

Main Features of the Mechanical Structure

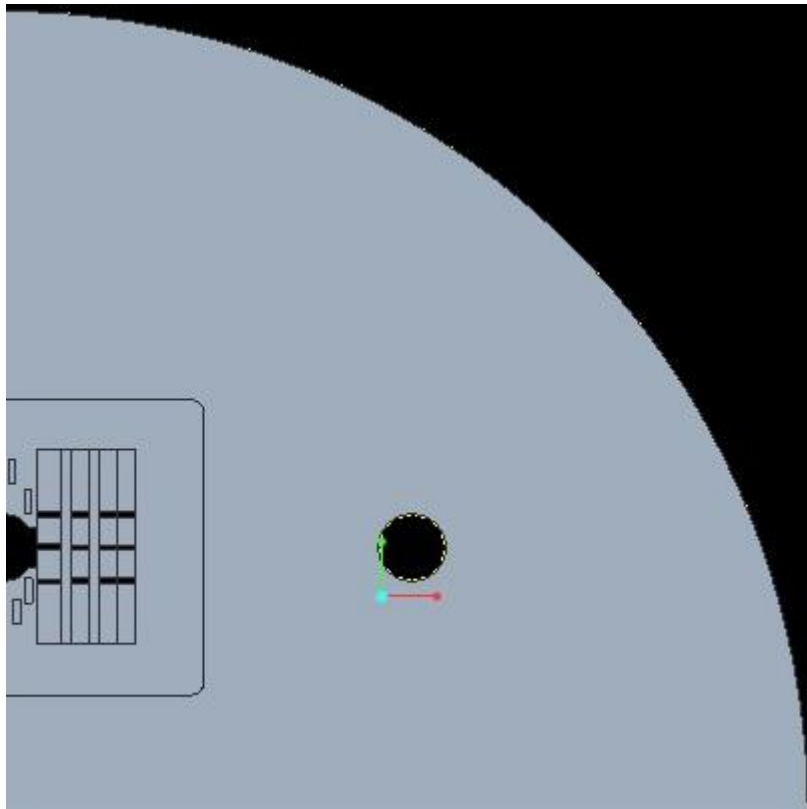

**$\frac{1}{4}$ of the full model
($\frac{1}{2}$ of one aperture)**

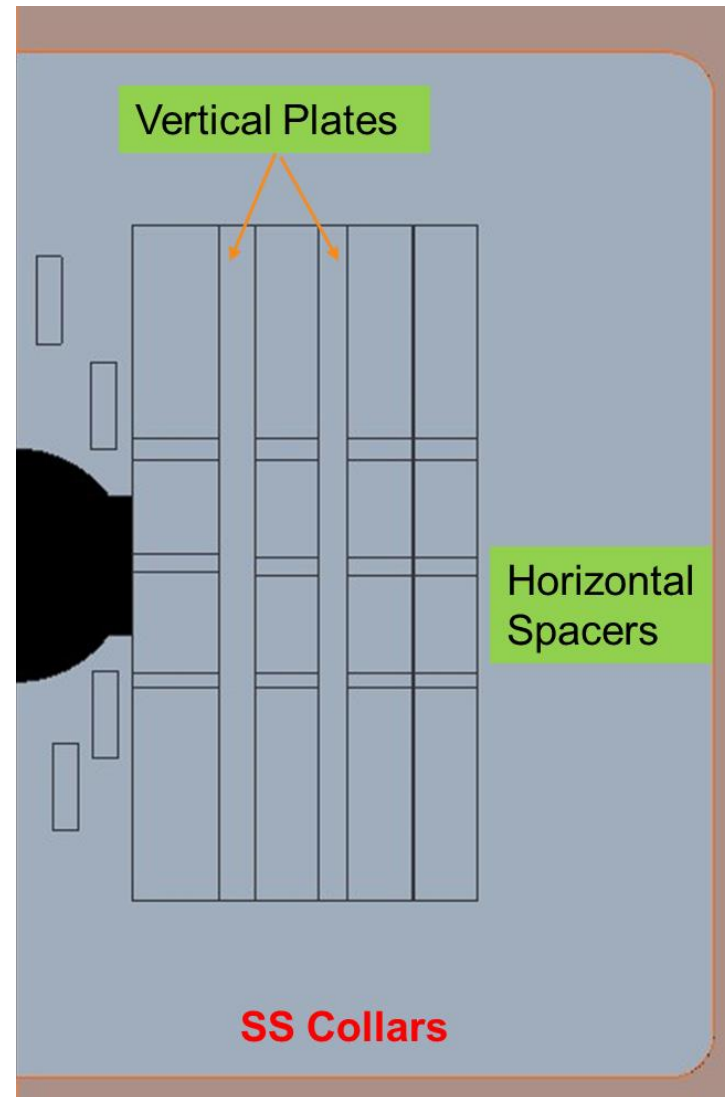

- 25 mm clear bore
- SS collars (+yoke and shell)
- Horizontal spacers to help transfer partial load to collar rather than the full load to next coil (note: spacers, like wedges, are part of the coil, not bonded to vertical plates)
- Vertical plates to distribute and transfer the loads

First order analysis follows the assumption mentioned by P. Ferracin (last talk).

Two cases examined:

- (a) vertical plates bonded to collar (but not to coils) for stress intercept,**
- (b) not bonded to collars**

Mechanical Analysis when Vertical Plates Bonded and NOT Bonded (overall results encouraging but the structure not yet optimized)

Vertical plates bonded to the collar at the top and bottom

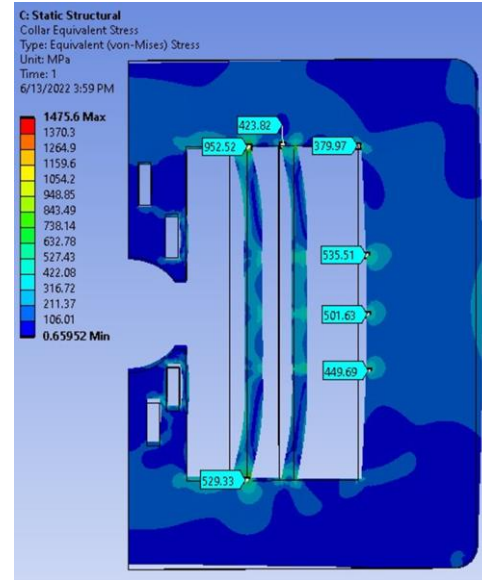
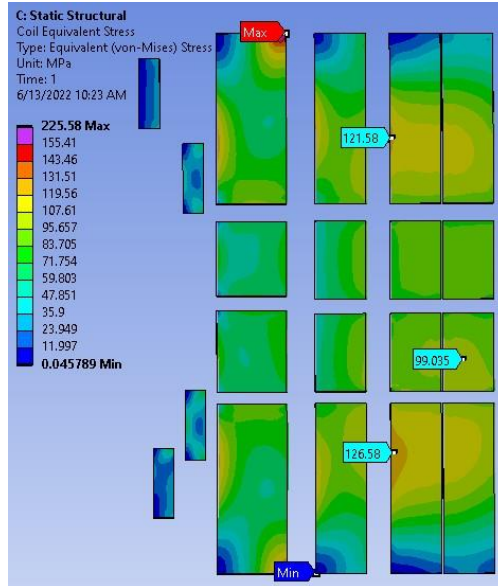

Vertical plates NOT bonded to the collar at the top and bottom

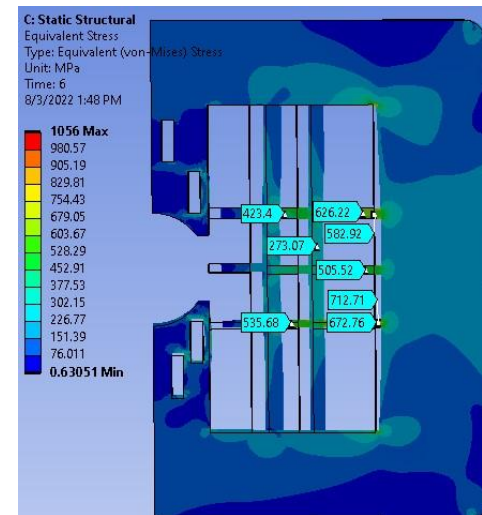
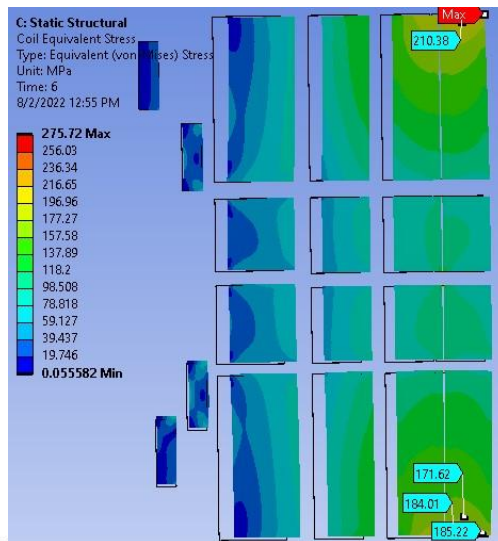

- Horizontal forces create bending at upper & lower corners of the coils generating local stresses
- In bonded plate case, stresses in Nb₃Sn coils are ok (max < 180 MPa) but more in HTS coil locally
- In non-bonded case, HTS coils ok (~100 MPa) but Nb₃Sn >270 MPa
- Solutions to be examined: (a) increasing vertical plate thickness and/or horizontal spacers, (b) apply pre-stress, etc.

It's a simple structure and the pole coils are held well

List of Major Tasks Remaining

Major yet to be performed:

- Iterate mechanical and magnetic designs.
- Perform quench protection analysis.
- Develop concepts for assembling the magnet.
- Perform 3-d magnetic and 3-d mechanical analysis for a 20 T design.
- Perform refined mechanical analysis for practical 3-d structures.
- Several common coil dipoles with main coils have been built and tested; however, none with the pole coils necessary for the field quality. Build pole coils and demonstrate them in a proof-of-principle magnet (e.g. in DCC017).
- Perform cost estimates of R&D dipoles and for large scale series production.
- As a part of “comparative” task force, compare the complete package with other designs (including unique advantages and disadvantages)

Summary

- **MDP comparative study revealed that for very high field dipoles (20 T), common coil design uses significantly less conductor than in other designs.**
- **Common coil offers several advantages, some outlined in this presentation.**
- **A significant list of tasks still remaining to be completed before this design can be used in a future collider.**
- **This is a different design from others and provides new opportunities.**
- **A good opportunity for new scientists and engineers (who come with NO to little pre-conceived notions and biases) for doing pioneering work.**

Extra Slides

Common Coil Design for Collider Magnets



SLAC-R-591
Fermilab-TM-2149
June 4, 2001

Design Study for a Staged Very Large Hadron Collider

Report by the collaborators of
The VLHC Design Study Group:
Brookhaven National Laboratory
Fermi National Accelerator Laboratory
Laboratory of Nuclear Studies, Cornell University
Lawrence Berkeley National Laboratory
Stanford Linear Accelerator Center
Stanford University, Stanford, CA, 94309

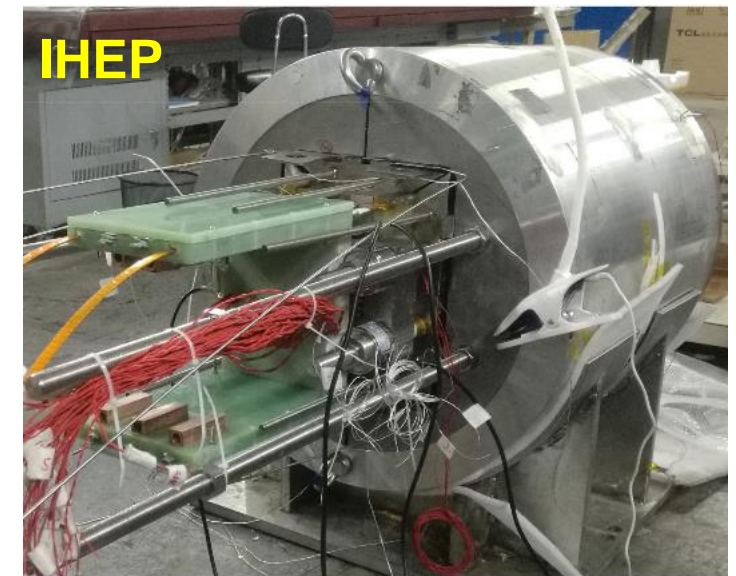
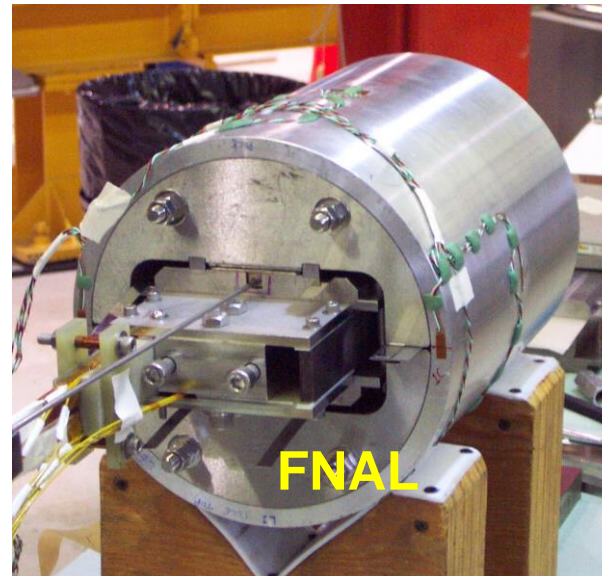
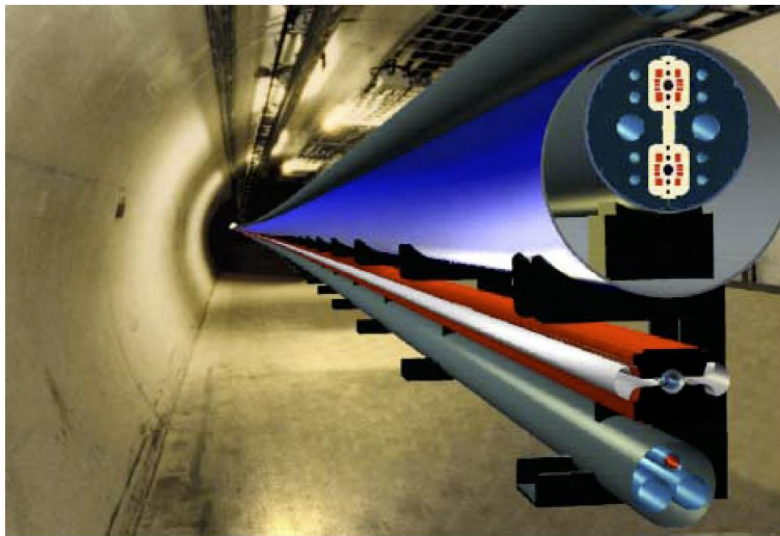
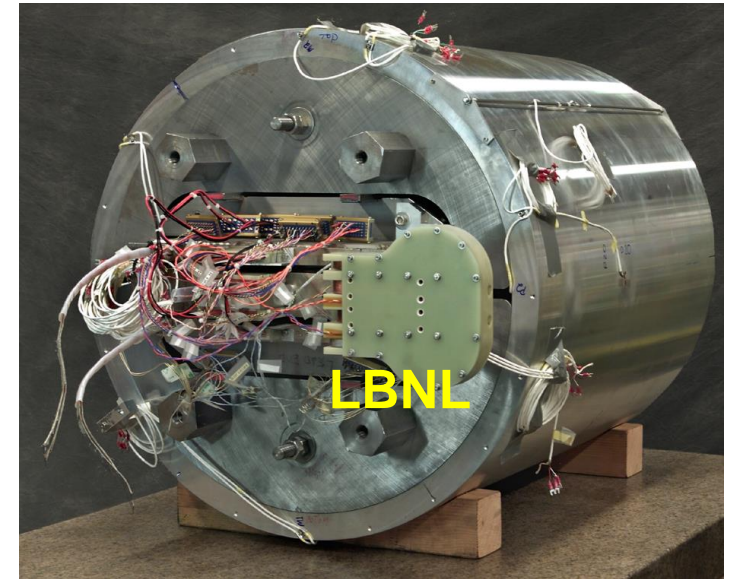

Work supported in part by the Department of Energy contract DE-AC03-76SF00515.
Brookhaven
National Laboratory

Demonstration of Good Field Quality in Ends

Up-down asymmetry will give large skew harmonics, if done nothing.

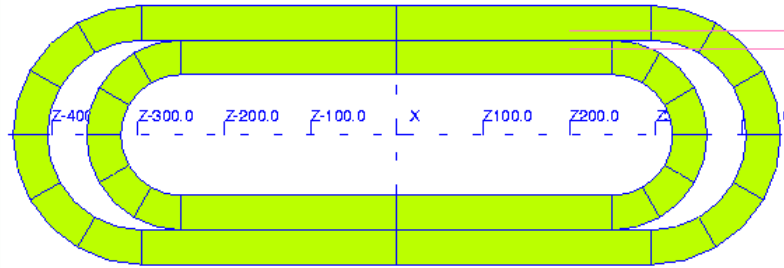

However, it can be easily compensated with the end spacers. Integral $B_y dl$ 10 mm above & 10 mm below midplane.

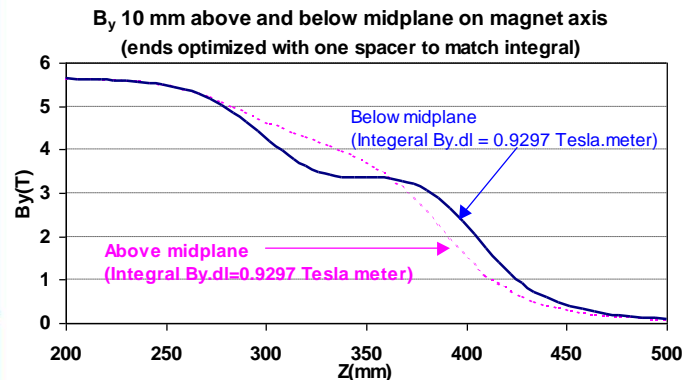

End harmonics can be made small in a common coil design.

End harmonics in Unit-m (Very small)

n	Bn	An
2	0.00	0.00
3	0.01	0.00
4	0.00	-0.03
5	0.13	0.00
6	0.00	-0.10
7	0.17	0.00
8	0.00	-0.05
9	0.00	0.00
10	0.00	-0.01
11	-0.01	0.00
12	0.00	0.00
13	0.00	0.00
14	0.00	0.00
15	0.00	0.00
16	0.00	0.00
17	0.00	0.00
18	0.00	0.00

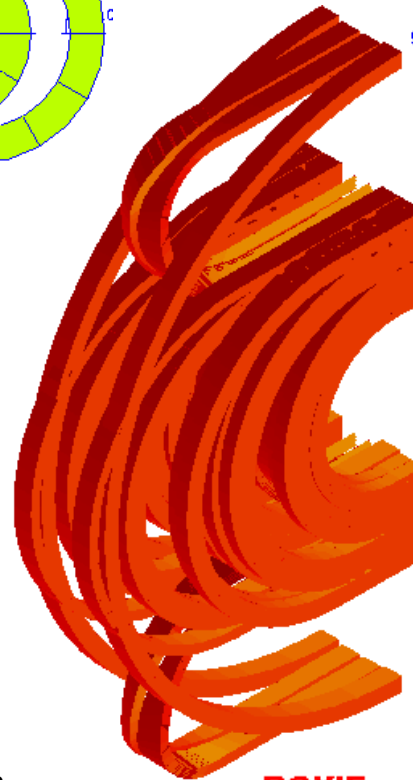

Contribution to integral (a_n, b_n) in a 14 m long dipole ($< 10^{-6}$)

n	b_n	a_n
2	0.000	0.001
3	0.002	0.000
4	0.000	-0.005
5	0.019	0.000
6	0.000	-0.014
7	0.025	0.000
8	0.000	-0.008
9	-0.001	0.000
10	0.000	-0.001
11	-0.001	0.000
12	0.000	0.000

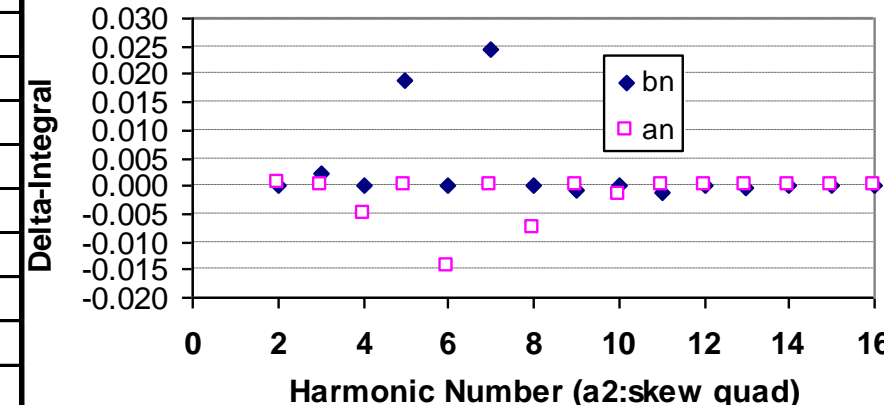

One of the most critical thing that needs be demonstrated in a common coil magnet

- Although several common coil designs have been designed with a variety of conductor (NbTi, Nb₃Sn, Bi2212, Bi2223, ReBCO), all have been made with the main coil only
 - The most efficient design to obtain good field is the one with the pole coils
 - We need to demonstrate a proof-of-principle design for pole coils that clear the bore tube. Many geometry considered but none demonstrated.
- Pole coils can be built, integrated and tested with the main coils in the BNL common coil dipole DCC017. It can be done in a short period and at a low cost for coil made at any lab.

A Few Possible Layouts of Pole Coils Clearing the Bore (other geometries discussed elsewhere)

Overpass/underpass (cloverleaf) design

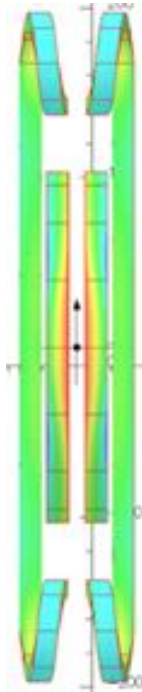
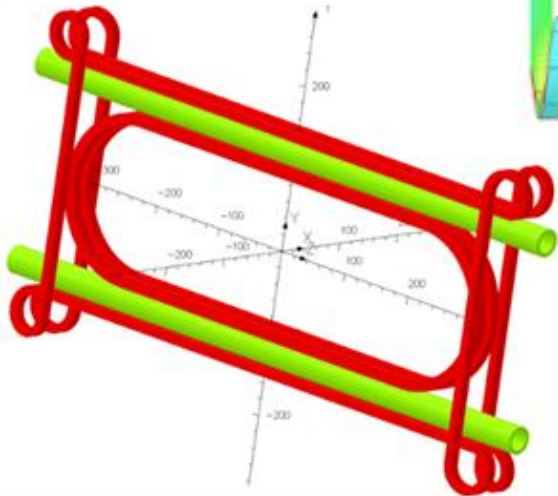
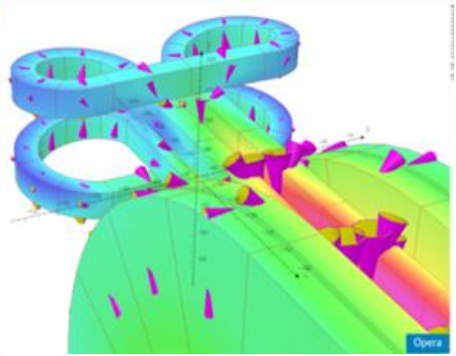

Practice pole coil windings and preliminary designs performed under “three” SBIR Phase I. They can be built and tested at 10+ T field as a part of common coil dipole DCC017 under MDP.

CERN is also working on this design

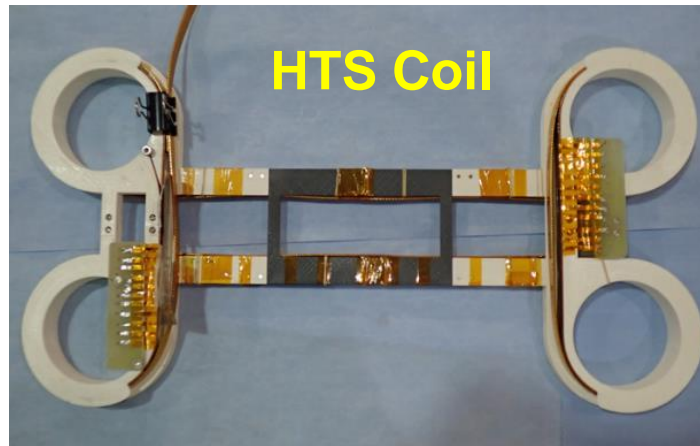

HTS Coil

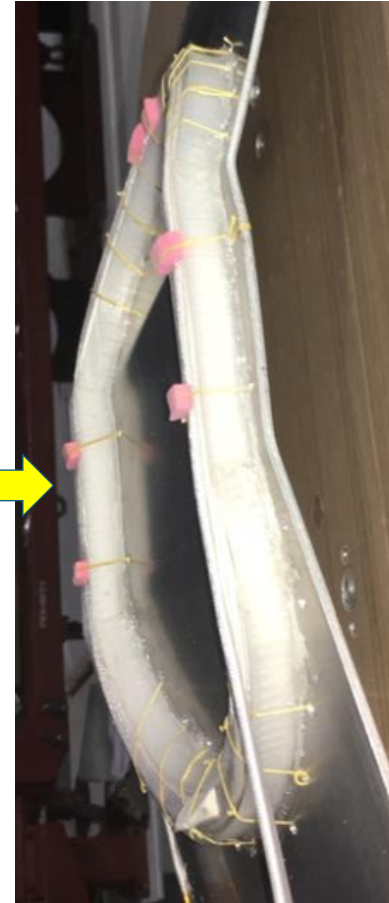
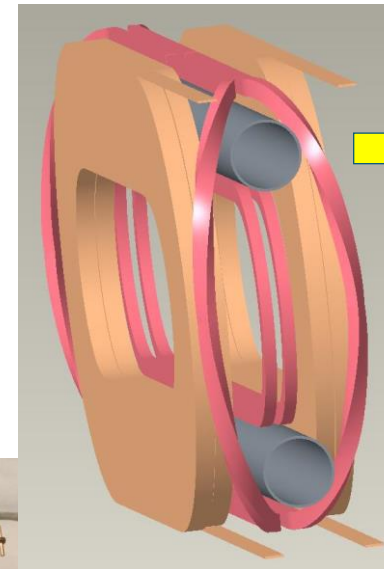

Nb₃Sn Coil

CERN (Glyn Kirby) has shown strong interest in collaborating

Splices in Common Coil Design (between two single layer coil)

In common coil design, splice (even between two types of coils), can be easily made in the middle of the coil where the field is very low

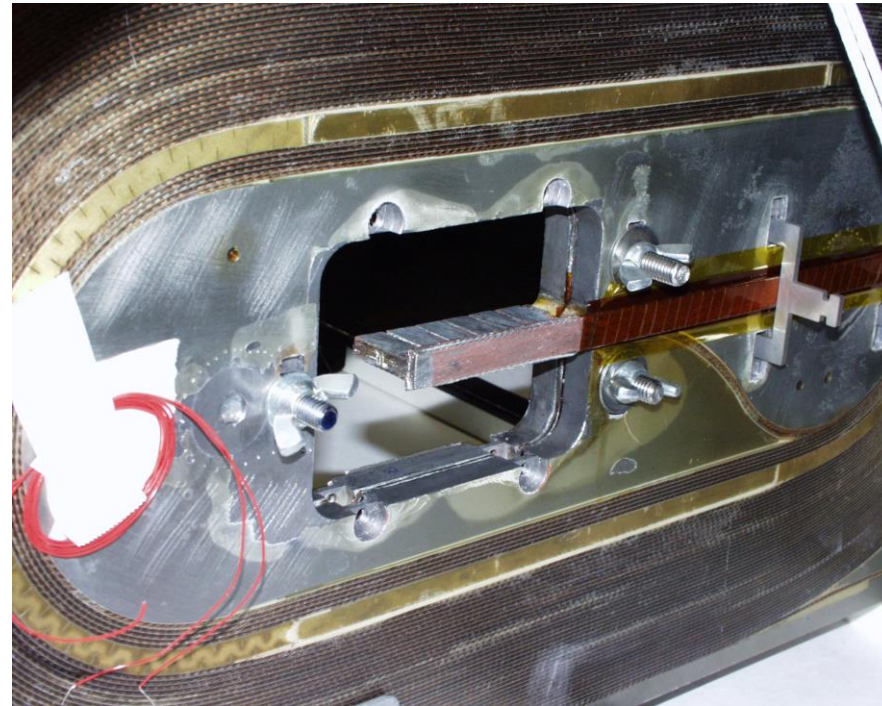

Perpendicular Nb-Ti splice in the low field region of BNL common coil dipole DCC017

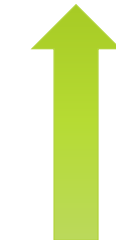
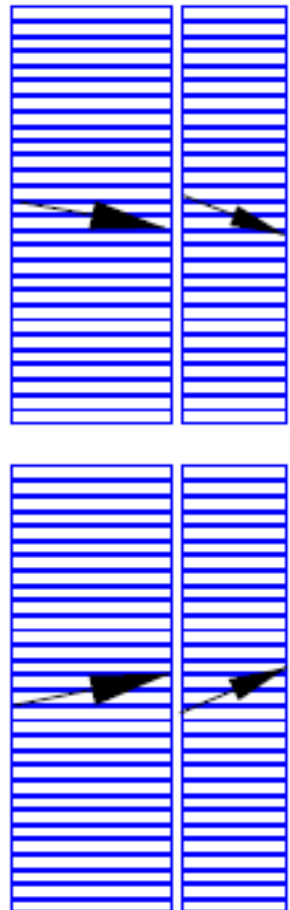
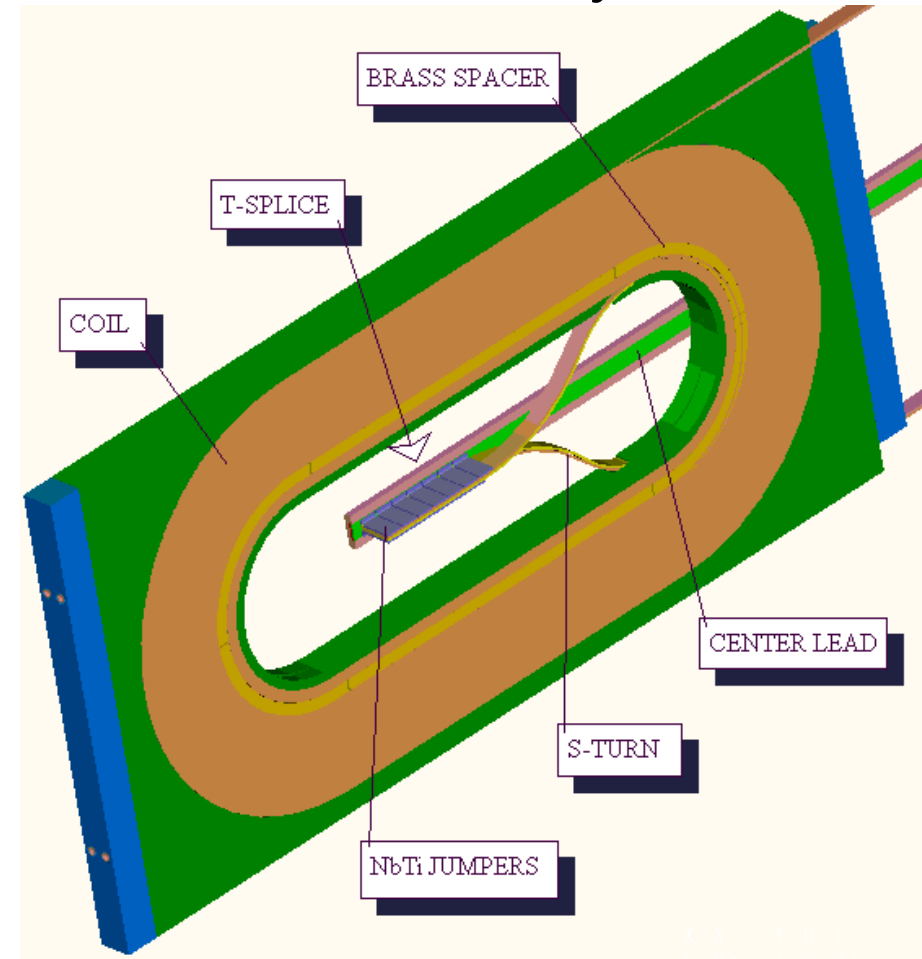

Coil Geometries for Very High Field Dipoles (coil width much greater than the magnet bore)

Situation changes for high field designs when the coil width (area) becomes much larger than the bore (aperture). One must evaluate again the impact on geometry and other constraints.

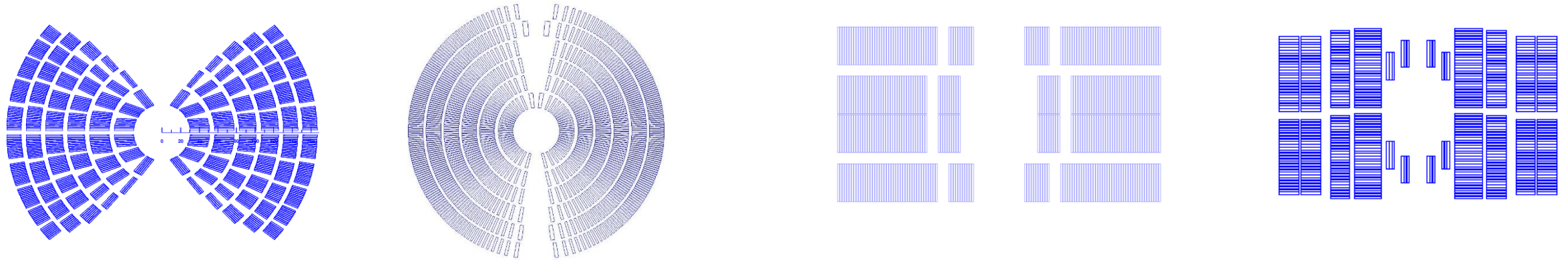

Variables and constraints to optimize the cosine theta and the canted cosine theta designs:

- Total coil width (radial width – free to grow)
- Pole Angle (limited to 90° max., 60° min. for $b_3=0$)
- Field quality: use wedges (may be used for structure)
- Radial space between layers for structure element

Variables and constraints to optimize the block coil and the common coil designs:

- Total coil width (horizontal width – free to grow)
- Coil Height (vertical height – free to grow) – major difference from the cos θ or canted cosine theta
- Field quality: use spacer (structure) & pole coils
- Horizontal space for structure elements

Coil Geometries for Low to Medium Field Dipoles (coil width much less than the magnet bore)

Accelerator magnets typically have circular bore. Therefore, a shell geometry is a natural choice. At low fields, the required width (and area) of conductor needed is much less than bore. One can design magnets with a single layer coil (RHIC). Block coil geometry will require many coils (layers) and may also use more conductor.

Design guidelines from the first principle:

Cosine theta design

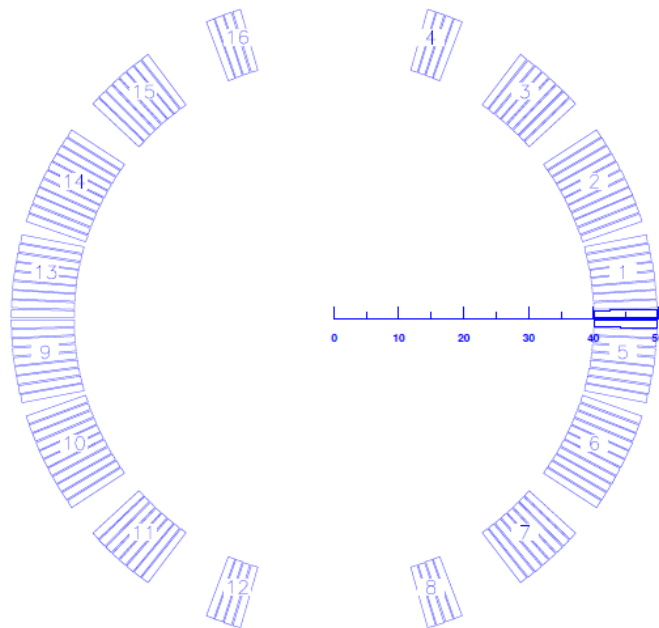

- In a $\cos(\theta)$ design, coil must extend to 60° (or more with wedges but limited to 90°) for $b_3=0$
- B is proportional to the width * (current density)
- Conductor area needed to create the dipole field increases linearly with the radius of each layer
- In low field block coil designs, extending coil vertically (with no limit) for field quality or to reduce number of layers is not effective
- At low fields, block coil designs appear less efficient and less elegant. They have not been used in any major conductor dominated design

Block Coil Design

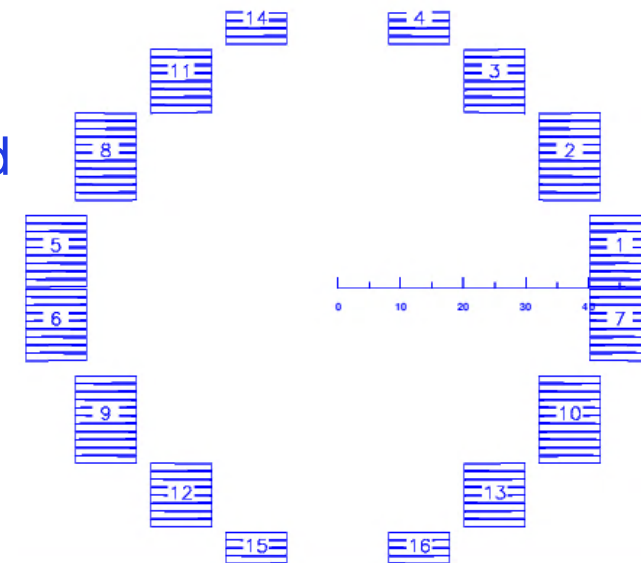

Optimization of 20 T Design – max area & max field (coil area much larger than the bore area)

$|B|$ (T) Need six layers (of which 2 to 4 layers must be of HTS)

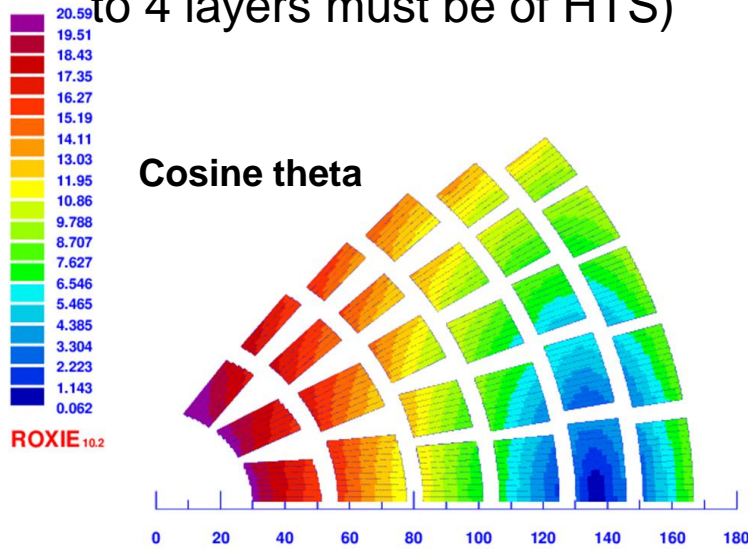

4-layer design (HTS: only 1 layer)

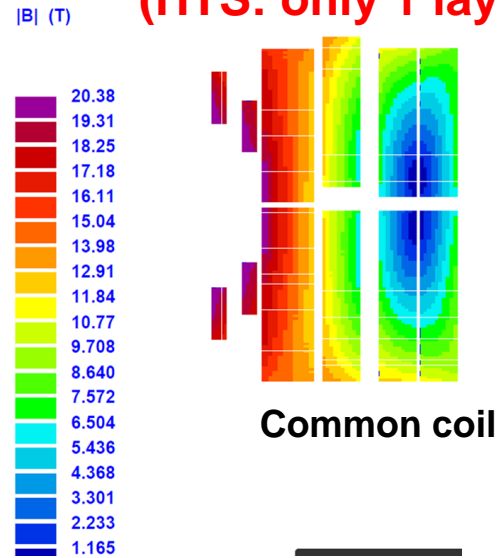

- In $\cos \theta$ and canted cosine theta, certain coil thickness or # of layers, are needed to create field.
- The same thickness (#of layers) must continue to the pole (60 to 80 degrees), the fill in between is determined by the cosine theta optimization.
- The field remains high at pole for many layers, means may need HTS, depending on the angle.
- Outer layers of current cosine theta designs, need to be extended to larger angle for field quality, which will use more conductor without creating much field.
- Furthermore, since the field will be higher there, the need for HTS and more layers of HTS will grow.

Canted cosine theta

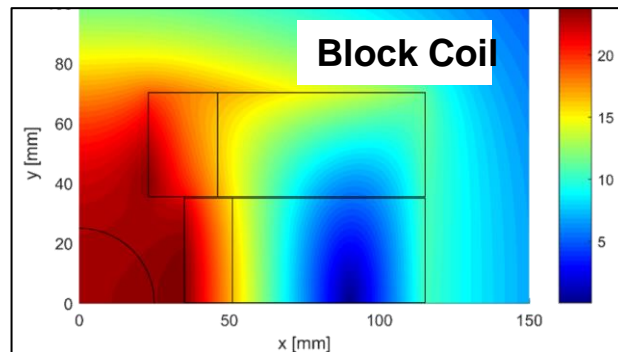
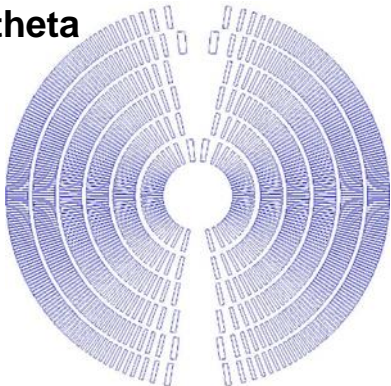

- Situation is very different in the common coil design.
- Horizontal and vertical sizes are decoupled. This provides flexibility and saving on the conductor.
- Moreover, the separation between the very high field and medium field region is good between the layers.
- This means that the HTS is needed only in one layer!

Conductor

Superconducting materials: J_e and J_o

- Assumptions for magnetic analysis
 - J_e = Strand current / strand area
 - $J_{e_LTS} = 875 \text{ A/mm}^2$ (1.9 K, 16 T, 5% degrad.)
 - 3000 A/mm² J_c (4.2 K, 12 T, virgin)
 - $J_{e_HTS} = 740 \text{ A/mm}^2$ (20 T)
 - Bi2212 value
 - J_o = Cable current / Cable_{insulated} area
 - $J_o = J_e \cdot 0.67$ (typical Rutherford cable)
 - Assumed also for HTS (Bi2212)
- Nb₃Sn and HTS cross at 16.5 T
- CORC wire still lower in both J_e (600 A/mm², 20 T) and J_o / J_e (0.54)

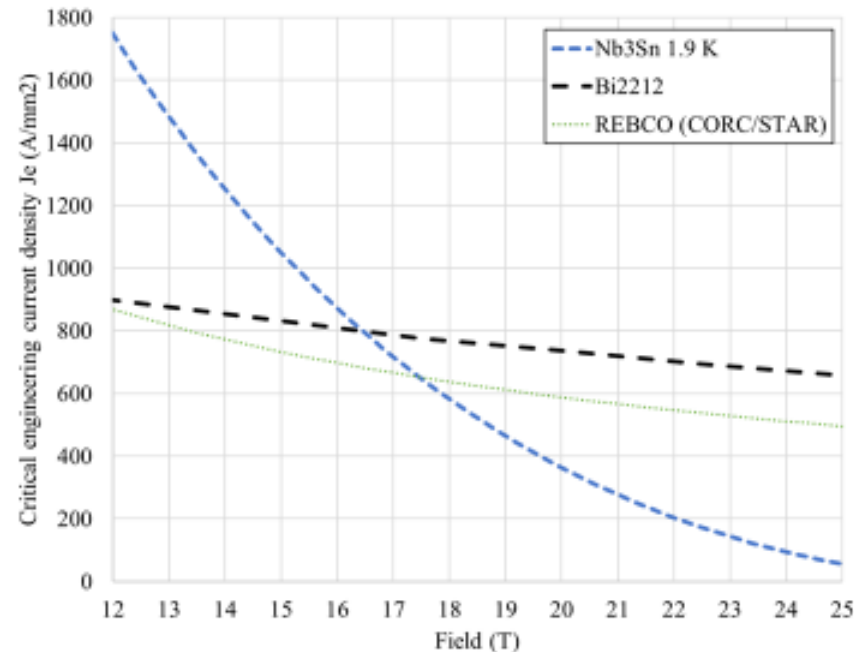

BI2212R	Bi2212
Bare w	1.52
Bare h	18.35
Insulation	0.15
Ins w	1.82
Ins h	18.65
Ins Area	33.943
Current	13600
J_e (A/mm ²)	487.60
J_o (A/mm ²)	400.67
Bpeak (T)	20.6951
MDPH2	Nb ₃ Sn
Bare w	1.6
Bare h	13.3
Insulation	0.15
Ins w	1.9
Ins h	13.6
Ins Area	25.840
Current	13600
J_e (A/mm ²)	639.10
J_o (A/mm ²)	526.32
Bpeak (T)	13.6701

Strategy Behind the Mechanical Structure (take advantage of the force distribution)

Forces @20 T (Mostly horizontal, particularly on HTS coils). Key Components of the Structure: Vertical Plates, Horizontal Spacers, Collars, Yoke and Shell

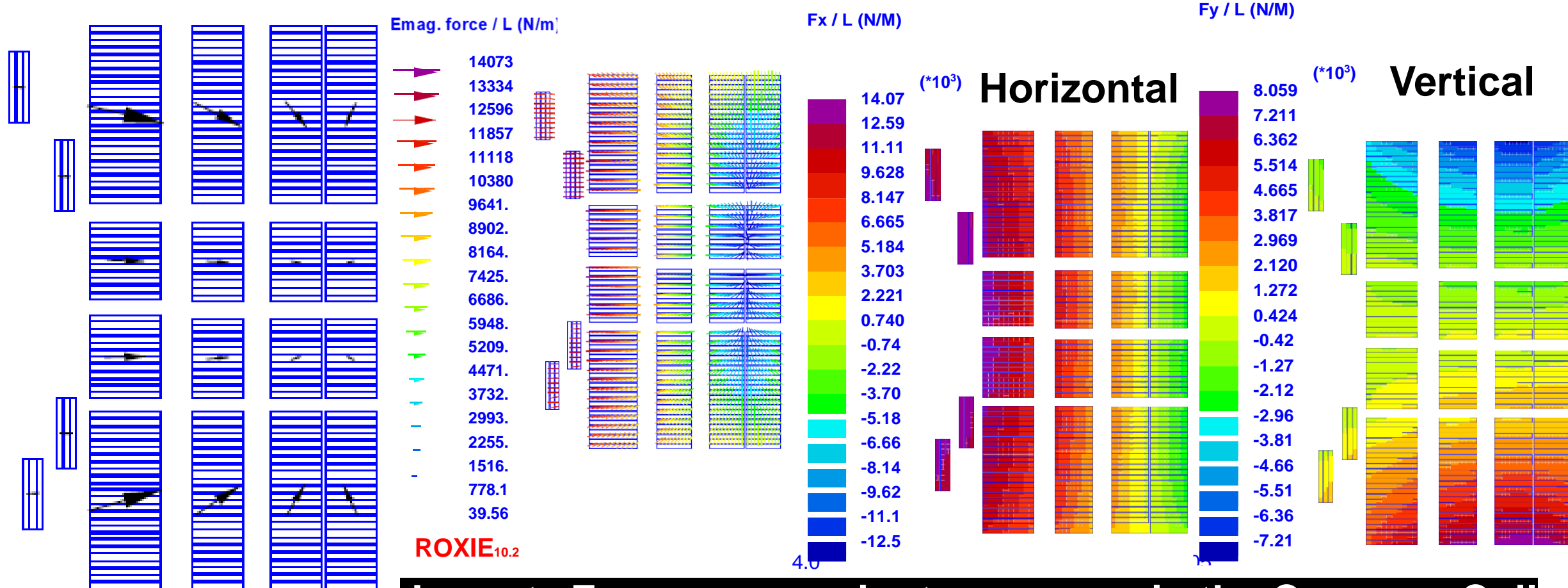

Lorentz Forces are easier to manager in the Common Coil

Field Quality in Common Coil Geometries

(all designs presented at MT27 had 10^{-4} harmonics)

6-layer design

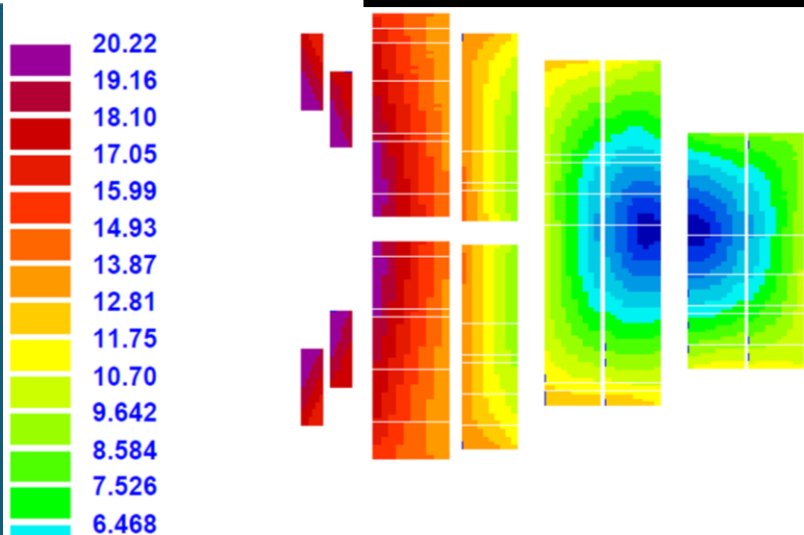

Running ROXIE on file mdp_oct-2021-Bi2212-i0.data...

MAIN FIELD (T)	19.9887
MAGNET STRENGTH (T/(m ⁿ⁻¹))	19.98

NORMAL RELATIVE MULTIPOLES (1,D-4):

b 1:	10000.00000	b 2:	-0.00000	b 3:	-0.00543
b 4:	-0.00000	b 5:	-0.02774	b 6:	-0.00000
b 7:	-0.13070	b 8:	-0.00000	b 9:	-1.40287
b10:	-0.00000	b11:	-0.41513	b12:	0.00000
b13:	0.01694	b14:	0.00000	b15:	-0.00172
b16:	-0.00000	b17:	-0.01059	b18:	-0.00000
b19:	-0.00040	b20:	0.00000	b	

SKREW RELATIVE MULTIPOLES (1,D-4):

a 1:	0.00000	a 2:	0.00838	a 3:	0.00000
a 4:	-0.01362	a 5:	0.00000	a 6:	0.03506
a 7:	0.00000	a 8:	-0.75858	a 9:	0.00000
a10:	-0.26750	a11:	0.00000	a12:	0.01863
a13:	0.00000	a14:	-0.00453	a15:	-0.00000
a16:	-0.01161	a17:	0.00000	a18:	0.00013
a19:	0.00000	a20:	0.00099	a	

5-layer design

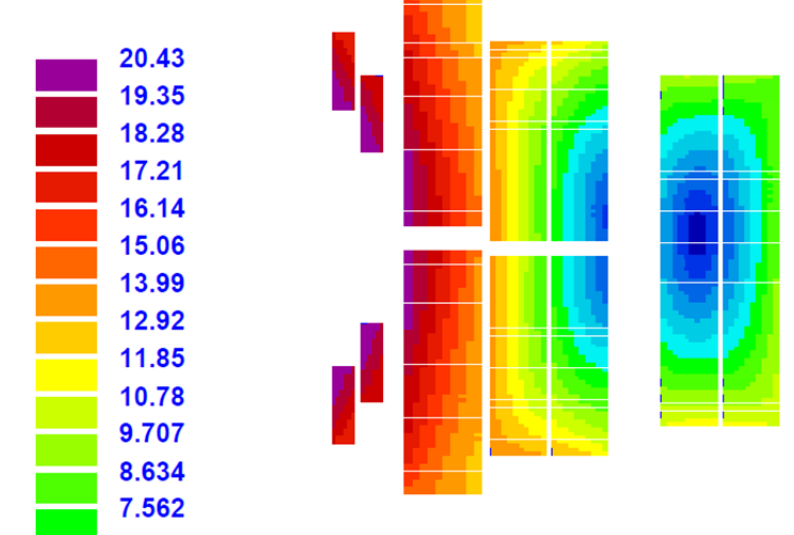

MAIN FIELD (T)	20.171
MAGNET STRENGTH (T/(m ⁿ⁻¹))	20.1

NORMAL RELATIVE MULTIPOLES (1,D-4):

b 1:	10000.00000	b 2:	0.00000	b 3:	1.74349
b 4:	-0.00000	b 5:	-0.14682	b 6:	-0.00000
b 7:	-0.06433	b 8:	0.00000	b 9:	-1.35518
b10:	0.00000	b11:	-0.33971	b12:	-0.00000
b13:	0.01717	b14:	-0.00000	b15:	-0.00691
b16:	-0.00000	b17:	-0.00836	b18:	-0.00000
b19:	-0.00005	b20:	-0.00000	b	

SKREW RELATIVE MULTIPOLES (1,D-4):

a 1:	0.00000	a 2:	0.51270	a 3:	-0.00000
a 4:	-0.05237	a 5:	-0.00000	a 6:	0.09507
a 7:	0.00000	a 8:	0.84674	a 9:	-0.00000
a10:	0.25613	a11:	-0.00000	a12:	-0.00656
a13:	0.00000	a14:	0.01272	a15:	0.00000
a16:	0.01090	a17:	0.00000	a18:	0.00083
a19:	-0.00000	a20:	0.00046	a	

4-layer design

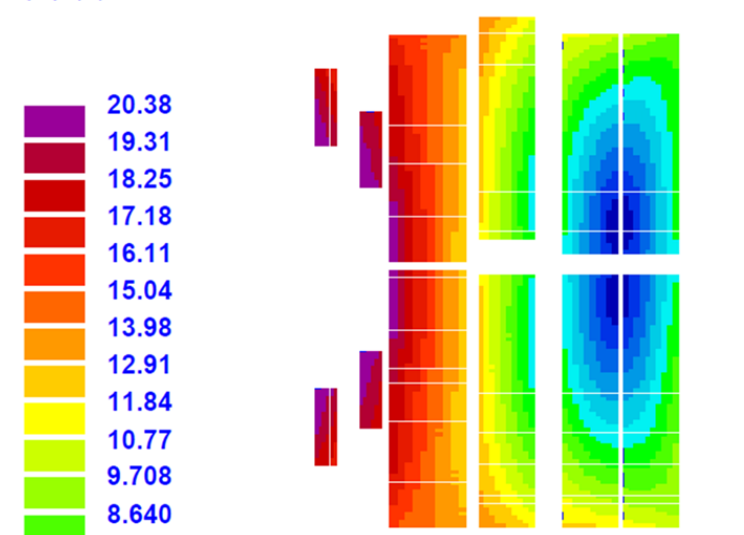

MAIN FIELD (T)	20.0236
MAGNET STRENGTH (T/(m ⁿ⁻¹))	20.0236

NORMAL RELATIVE MULTIPOLES (1,D-4):

b 1:	10000.00000	b 2:	0.00000	b 3:	0.03617
b 4:	-0.00000	b 5:	0.08401	b 6:	0.00000
b 7:	0.39419	b 8:	-0.00000	b 9:	0.78556
b10:	0.00000	b11:	-0.00864	b12:	-0.00000
b13:	-0.08354	b14:	-0.00000	b15:	-0.01549
b16:	0.00000	b17:	0.00697	b18:	-0.00000
b19:	0.00128	b20:	-0.00000	b	

SKREW RELATIVE MULTIPOLES (1,D-4):

a 1:	0.00000	a 2:	0.01594	a 3:	0.00000
a 4:	0.09502	a 5:	0.00000	a 6:	0.05581
a 7:	0.00000	a 8:	-0.50366	a 9:	-0.00000
a10:	0.49972	a11:	0.00000	a12:	0.15736
a13:	-0.00000	a14:	-0.04431	a15:	0.00000
a16:	-0.00486	a17:	-0.00000	a18:	0.00185
a19:	-0.00000	a20:	0.00141	a	

The effect of increasing thickness of vertical plates

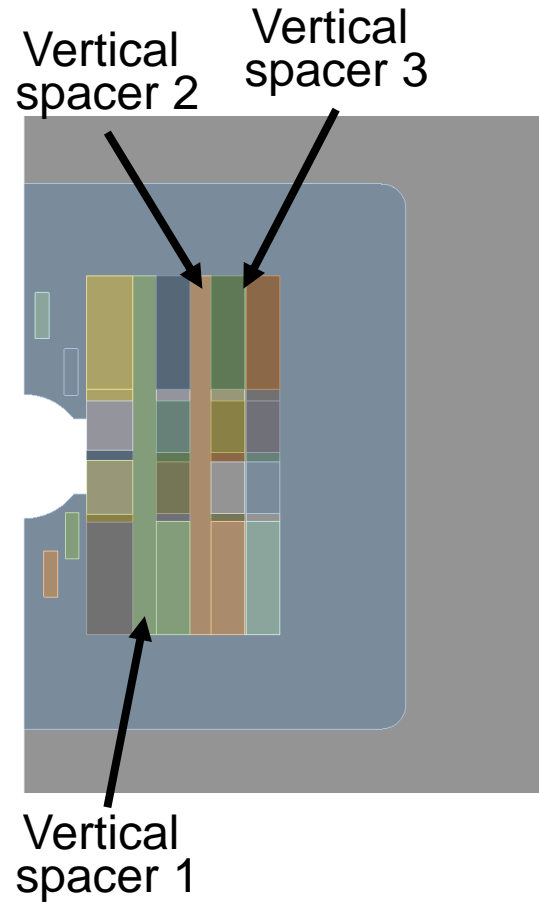

The effect of increasing vertical spacer 1 and 2 thickness by 2 mm

C: Static Structural
Coil Equivalent Stress
Type: Equivalent (von-Mises) Stress
Unit: MPa
Time: 6
Max: 224.7
Min: 0.02674

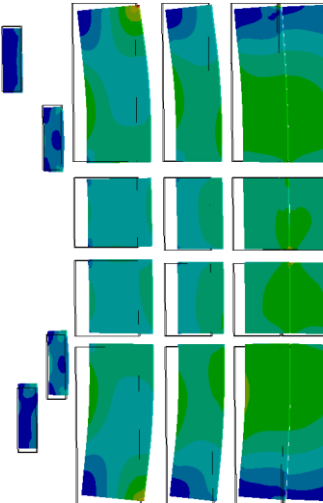
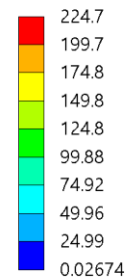

C: Static Structural
Equivalent Stress - Coil
Type: Equivalent (von-Mises) Stress
Unit: MPa
Time: 1
Max: 200.32
Min: 0.011779

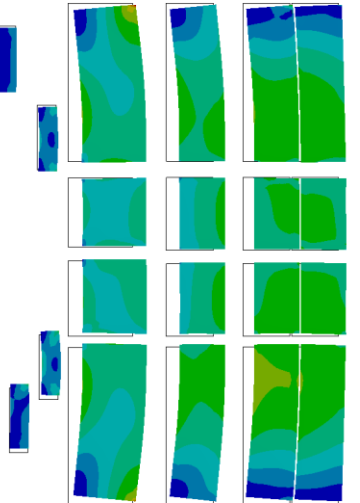
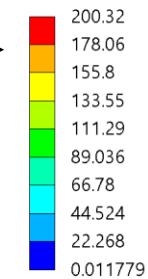

Benefits of the Common Coil Design

Common Coil Design and it's Potential Advantages

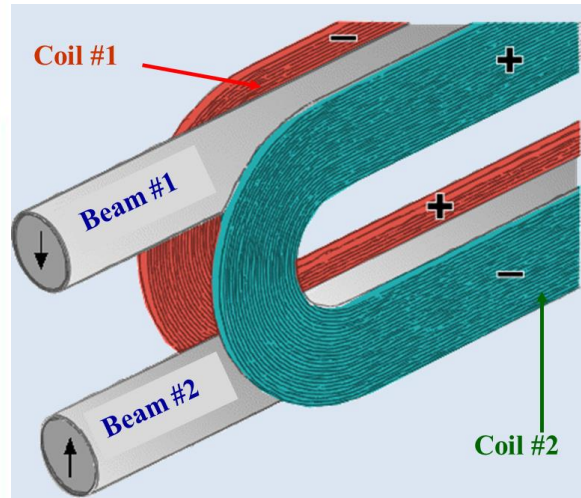

- **Simple 2-d coil geometry** for collider dipoles
- **Conductor friendly design** with large bend radii (determined by the spacing between two apertures). Less sensitive to conductor degradation.
- **20 T dipole uses significantly less conductor** than used in other designs
- **Efficient segmentation** between LTS and HTS coils for HTS/LTS hybrid dipoles
- **Mechanically handles well the large Lorentz forces** associated with the high fields, creating lower internal strain on conductor despite large deflections
- **Fewer coils (half)** as the same coils are common between the two apertures
- **Simple magnet geometry and simple tooling**, expect lower costs
- **Identical design** can be used for all Nb₃Sn coils
- **Allows both React & Wind and Wind & React options**
- **Allows more technology options** for insulation, etc.
- **Allows rapid-turn-around, low-cost R&D** for systematic and innovative studies
-

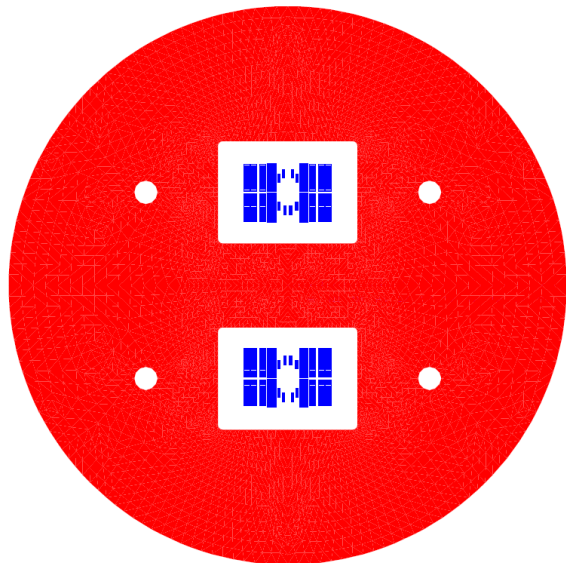

Benefit of Common Coil: Interfaces

- Interfaces are going to be a major issues in very high field magnets where we must deal with large Lorentz forces
- Both Canted Cosine Theta (CCT) and Stress Managed Cosine Theta (SMTC) are going to have many interfaces
- Gaps must be left for expanding cable in reaction and they should be filled with the epoxy. Since epoxy is not a strong material. It shouldn't be too thick to minimize cracking (can that be avoided in complex structures where it will be difficult to fill in the gaps)
- By contrast, the common coil structure, as it appears to be developing now, should have fewer and simpler interfaces!

Benefit of CC: Less Conductor Degradation and More Conductor/Cable Options

Common Coil: Conductor friendly design with large bend radii (order of magnitude more than others)

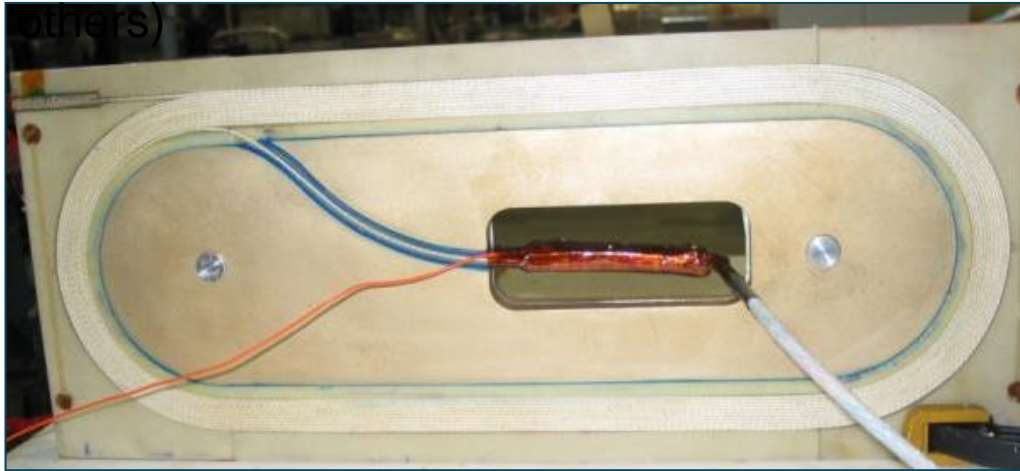

React & Wind Bi2212 Rutherford cable coil built and tested

Cables must be bent in much smaller radii in CT/SMCT/CCT as compared to that in CC



- Conductor degradation (both in Nb_3Sn and in HTS) is a major issue in high field magnets
- Larger degradation expected in coil ends with relatively complex geometries with small bend radii
- Smaller degradation is expected in the common coil designs with simpler ends and large bending radii.

- Many cables, including those that developed for the fusion (where a lot of investment is being made), can't be used in Cos theta or CCT since many of them can't be bent in small radii. However, they can be used in the common coil because of larger radii.
- Performance, reliability and cost of many cables can be reduced if they don't have to be bent so tightly