



*Get D.K.F. for
Board Report*

REPORT OF APOLLO 13 REVIEW BOARD

- APPENDIX F - SPECIAL TESTS AND ANALYSES
- APPENDIX G - BOARD ADMINISTRATIVE PROCEDURES
- APPENDIX H - BOARD RELEASES AND PRESS STATEMENTS

FACILITY FORM 602

N70-78616 (THRU) _____
 (ACCESSION NUMBER)

210 (CODE) None
 (PAGES)

TMX-66471 (CATEGORY) _____
 (NASA CR OR TMX OR AD NUMBER)

NATIONAL AERONAUTICS AND SPACE ADMINISTRATION

— — —

APPENDIX F
SPECIAL TESTS AND ANALYSES

CONTENTS

Part		Page
	APPENDIX F - SPECIAL TESTS AND ANALYSES	
F1	<u>INTRODUCTION</u>	F-1
F2	<u>SUMMARY OF TESTS AND ANALYSES</u>	F-3
	DETANKING AT KENNEDY SPACE CENTER	F-3
	QUANTITY GAGE DROPOUT	F-3
	IGNITION AND COMBUSTION PROPAGATION	F-3
	TANK FAILURE	F-4
	PANEL LOSS	F-4
F3	<u>SELECTED TESTS AND ANALYSES</u>	F-5
F3.1	THERMAL SWITCH TESTS	F-7
	Objective	F-7
	Approach and Results	F-7
	Conclusions	F-7
F3.2	TEFLON INSULATION DAMAGE DUE TO OVERHEATING	F-9
	Objective	F-9
	Approach and Results	F-9
	Conclusions	F-9
F3.3	THERMODYNAMICS AND COMBUSTION ANALYSIS OF OXYGEN TANK PROCESSES	F-12
	Energy Required to Account for Measured Pressure Rise	F-12
	Energy Available in the Potentially Combustible Materials in the Tank	F-14
	Potential Ignition Energy	F-14

Part		Page
F3.4	TEFLON INSULATION IGNITION ENERGY TEST	F-19
	Objective	F-19
	Approach	F-19
	Results	F-21
	Conclusion	F-21
F3.5	IGNITION AND PROPAGATION THROUGH QUANTITY PROBE SLEEVE AND CONDUIT	F-23
	Objective	F-23
	Experimental	F-23
	Results	F-26
	Conclusions	F-27
F3.6	ZERO-g TEFLON FLAME PROPAGATION TESTS	F-42
	Objective	F-42
	Apparatus	F-42
	Approach	F-42
	Results	F-43
	Conclusions	F-43
F3.7	FULL-SCALE SIMULATED OXYGEN TANK FIRE	F-48
	Objectives	F-48
	Apparatus	F-48
	Results	F-48
	Conclusions	F-49

Part		Page
F3.8	ANALYSIS OF FLOW FROM RUPTURED OXYGEN TANK	F-55
	Objective	F-55
	Assumptions	F-55
	Method	F-55
	Results	F-56
	Discussion and Conclusions	F-61
F3.9	MYLAR-INSULATION COMBUSTION TEST	F-63
	Objective	F-63
	Apparatus	F-63
	Approach	F-63
	Results	F-63
	Conclusion	F-64
F3.10	PANEL SEPARATION TESTS	F-70
	Objectives	F-70
	Approach	F-70
	Apparatus	F-71
	Results and Discussion	F-74
	Conclusions	F-82
F4	<u>MASTER LIST OF TESTS AND ANALYSES</u>	F-83
F5	<u>FAULT TREE ANALYSIS - APOLLO 13 ACCIDENT</u>	F-107
	<u>REFERENCES</u>	F-142

This page left blank intentionally.

PART F1

INTRODUCTION

An integral part of the Apollo 13 Review Board's effort included an extensive test and analysis program to evaluate in detail postulated modes of failure. The majority of these tests and analyses were conducted at the Manned Spacecraft Center (MSC) and five other NASA centers--Langley Research Center (LRC), Ames Research Center (ARC), Lewis Research Center (LeRC), Marshall Space Flight Center (MSFC), and Kennedy Space Center (KSC). Some tests at White Sands Test Facility (WSTF), North American Rockwell, Beech Aircraft, Parker Aircraft, and Boeing were also conducted. The results of this intensive test and analysis program formed, to a large extent, the basis for the development of many of the Board's findings, determinations, and recommendations.

During the review, the requests for tests and analyses were channeled through the MSC Apollo Program Office, which maintained a master file. The selection of individual tests and analyses was made after a preliminary study by Review Board specialists. In each case the request was approved by the Board Chairman or a specially designated Board monitor. In many instances the preparation and execution of tests were observed by Apollo 13 Review Board representatives.

Nearly a hundred separate tests and analyses have been conducted. The level of effort expended on this test and analysis program included a total of several hundred people over a period of about 6 weeks.

The first portion of this Appendix is a summary of those tests and analyses which most precisely support the sequence of events during this accident. This is followed by a more detailed description of these tests and analyses. This Appendix concludes with a test and analyses master list and a fault tree analysis.

It should be noted that an attempt has been made to include all tests that have been carried out in support of this review in the master list. As a result, the list includes a number of early tests which were exploratory, and in some cases inconclusive, and may not appear to lend substantive information. For each effort, there is summary information which includes identification, a statement of the objective, and a brief statement of results. More complete data on studies and tests can be found in the official files of the Apollo 13 Review Board.

This page left blank intentionally.

PART F2

SUMMARY OF TESTS AND ANALYSES

To assist the reader, a summary of the most significant tests and analyses is included in this part. The summary consists of a series of concise statements which are based on the results from one or more test or analysis. The summaries are presented in chronological order of the events as they occurred in the spacecraft.

DETANKING AT KENNEDY SPACE CENTER

A test simulating the conditions of the special detanking operations during the countdown demonstration test (CDDT) revealed that the thermal switches were overloaded and failed in the "closed" position. The failure of the thermostats caused very high temperatures (700° to 1000° F) inside the heater tubes. Damage to the wire insulation resulted from this overheating. Subsequent tests showed that under the conditions existing in the tank, the wire insulation would seriously degrade at temperatures between 700° F and 1000° F, thus exposing bare wire.

QUANTITY GAGE DROPOUT

Tests to determine the signal characteristics of the quantity probe under various fault conditions showed that a short between the concentric tubes would cause an off-scale high reading which would then go to zero when the short is removed, remain there for about 1/2 second, and then return to the correct indication in about 1-1/2 seconds. These are the characteristics that were observed in flight. It is not established that the failure of the quantity gage was related to the combustion that occurred in the oxygen tank no. 2.

IGNITION AND COMBUSTION PROPAGATION

The energy required to achieve the pressure rise from 887 psia to 1008 psia observed in oxygen tank no. 2 (10 to 130 Btu) can be supplied by the combustion of the Teflon wire insulation in the tank and conduit (260 Btu). Tests have also indicated that other Teflon elements and certain aluminum components inside the tank may also be ignited and thus contribute to the available energy.

Experiments show that the Teflon insulation on the actual wires in oxygen tank no. 2 can be ignited by an energy pulse which is less than the energy estimated to be available from the observed flight data.

Test of fuses in the motor power leads showed that sufficient energy to ignite Teflon insulation could be drawn through the fuses before they would blow.

The flame propagation rate experiments in supercritical oxygen indicate a rather slow burning rate along Teflon wire insulation (about 0.25 in/sec downward in one-g). Propagation rates as low as 0.12 in/sec were measured under zero-g conditions. These measurements are consistent with the slow rate of pressure rise observed in the spacecraft.

Under one-g conditions, Teflon wire insulation flames will propagate along the wire through apertures fitted with Teflon grommets.

TANK FAILURE

Several combustion tests confirmed that burning of Teflon and possibly aluminum could reach high enough temperatures to cause either the tank or the conduits into the tank to fail. Oxygen pressure was very likely lost due to the failure of the conduit.

A test in one-g in which the actual bundled Teflon insulated wire was ignited within the conduit leading from an oxygen tank and filled with supercritical oxygen resulted in bursting the heat-weakened conduit wall.

A test which contained an upper portion of the quantity probe and conduit showed that ignition of the motor lead bundle in supercritical oxygen results in flame propagation through the quantity probe insulator and into the conduit. Posttest examination showed an approximately 2-inch diameter hole had been burned out of a 3/8-inch thick stainless steel simulated tank closure plate.

PANEL LOSS

Tests with 1/2-scale honeycomb panel models in vacuum produced complete panel separation with a rapid band loaded pressure pulse in the oxygen tank shelf space. Peak pressures in the simulated tunnel volume with scaled venting were considerably lower (about 1/5) than that of the oxygen tank shelf space. These tests are consistent with the information obtained from the photographs of the service module taken by the Apollo 13 crew.

PART F3

SELECTED TESTS AND ANALYSES

This page left blank intentionally.

PART F3.1

THERMAL SWITCH TESTS

Objective

Determine the behavior of the thermostatic switches in the oxygen tank no. 2 under the conditions experienced during the abnormal detanking experienced at KSC. During the KSC tests, heater currents of 6.5 amperes at 65 V dc were used.

Approach and Results

Subsequent to discovering that the heater thermostatic switches most likely fused in the closed position during the KSC detanking procedures, tests were conducted to determine the power handling capabilities of these switches.

Batteries were used as a power source to test the switches. They were initially supplied with 31 V dc at currents up to 3.5 amperes. No contact degradation was observed under these conditions. When the voltage was raised to 65 V dc, some increase in contact resistance (up to about 3 ohms from a few milliohms) was noted at 1.25 amperes, although the switch continued to operate. The current was then increased to 1.5 amperes at 65 V dc; and when the switch attempted to open, it fused closed. The body of the switch was removed and the condition of the contact can be seen in figure F3.1-1.

Conclusions

Thermostatic switches similar to those in oxygen tank no. 2 will fuse closed when they attempt to open with a 65 V dc potential and currents in excess of 1.5 ampere.

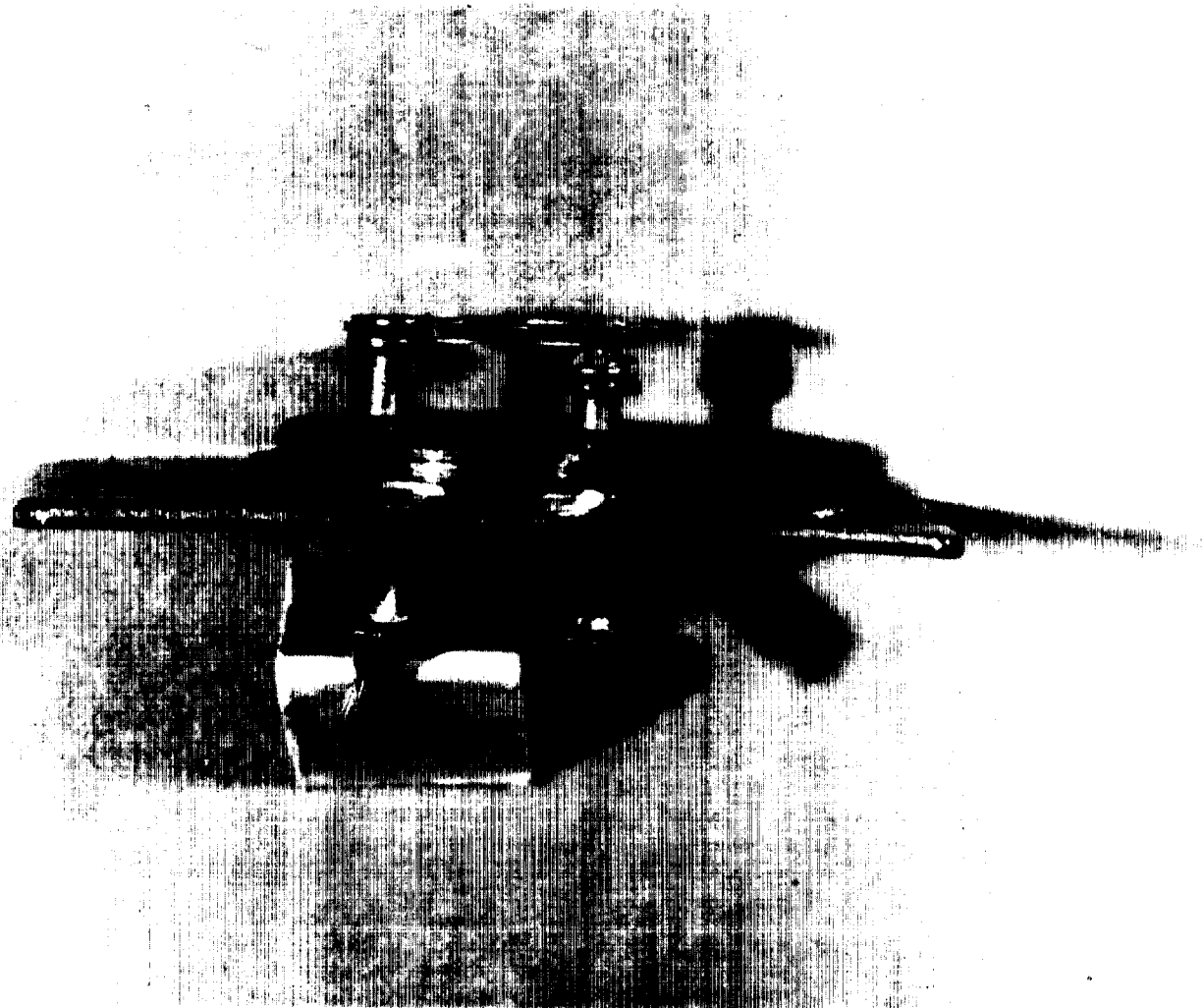

Figure F3.1-1.- Fused thermal switch control.

PART F3.2

TEFLON INSULATION DAMAGE DUE TO OVERHEATING

Objective

These tests were conducted to determine the damage that could have been done to the Teflon wire insulation during the abnormal detanking operation at Cape Kennedy.

Approach and Results

The likelihood that the equipment inside the oxygen tank was subjected to high temperatures for several hours prompted tests to reveal any changes in the thermochemistry of the remaining material. Four samples were treated in a heated oxygen flow system. The flow rate was 259 cc/sec. These samples were compared with an unbaked control sample. A typical sample of wire is shown in figure F3.2-1. The mass-loss results are given in table F3.2-I.

The relative values of heats of reaction in subsequent DTA tests in oxygen show that the degraded material is slightly more energetic per unit mass than the virgin material when oxidized.

Conclusions

The tests reveal that severe damage could have resulted to the wire insulation during the abnormal detanking procedure. In several places along the leads, bare wire was exposed which could have led to the short circuits that initiated the accident.

F-10



Figure F3.2-1.- Damaged Teflon insulation.

TABLE F3.2-I.- INSULATION DEGRADATION TESTS

Sample	Baking		
	Temperature, °F	Time, hr	Weight loss, percent insulation
1	77		0
2	572	2.75	+0.15
3	752	1.0	-0.08
4	860	0.5	-34.
5	932	0.5	-102.

PART F3.3

THERMODYNAMICS AND COMBUSTION ANALYSIS OF OXYGEN TANK PROCESSES

Since there is strong evidence that the failure centered around an abnormal energy addition to oxygen tank no. 2, it seems appropriate to include a special discussion of the analysis of the thermodynamics and combustion processes that may have occurred in this tank. Consideration is given here to (1) the energy required to account for the measured pressure rise, (2) the energy available in potentially combustible materials in the tank, and (3) potential ignition energy.

Energy Required to Account for Measured Pressure Rise

The measured abnormal pressure rise in oxygen tank no. 2 is presented in figure B5-3 of Appendix B. Calculations can be made for two limiting thermodynamic processes to account for this pressure rise. One process assumes that the pressure rise results from an isentropic compression of the supercritical oxygen by an expanding "bubble" of combustion products. This corresponds to the minimum amount of energy required to achieve the measured pressure rise. Another limiting process assumes that the energy addition is accompanied by complete mixing which results in homogeneous fluid properties.

Figure F3.3-1 is a pressure-enthalpy diagram for oxygen whereon point "A" is the thermodynamic state just prior to the abnormal energy addition, approximately -190° F and 887 psia. The path of the isentropic compression (minimum energy) from this state to the maximum pressure measured of 1008 psia is represented by line AB. Thermodynamic properties of oxygen presented by Weber (ref. 1) and Steward (ref. 2) were used to compute the increase in the internal energy of the oxygen. This internal energy increase of the oxygen (242 lb_m) amounts to about 10 Btu. The temperature increase associated with this process is about 1.8° F.

Figure F3.3-1 also shows the constant density path along line AC from 887 psia to 1008 psia. This process could be achieved by complete mixing of the tank contents. The internal energy increase for this case (maximum energy) is about 130 Btu. The temperature increase for this process is 2.6° F. It should be noted that this energy addition is to the oxygen in the tank. It does not include energy that might be added to other tank components such as metal parts.

The measured temperature rise of 38° F (indicated by figure B5-3 in Appendix B) during the pressure rise to 1008 psia cannot be explained by

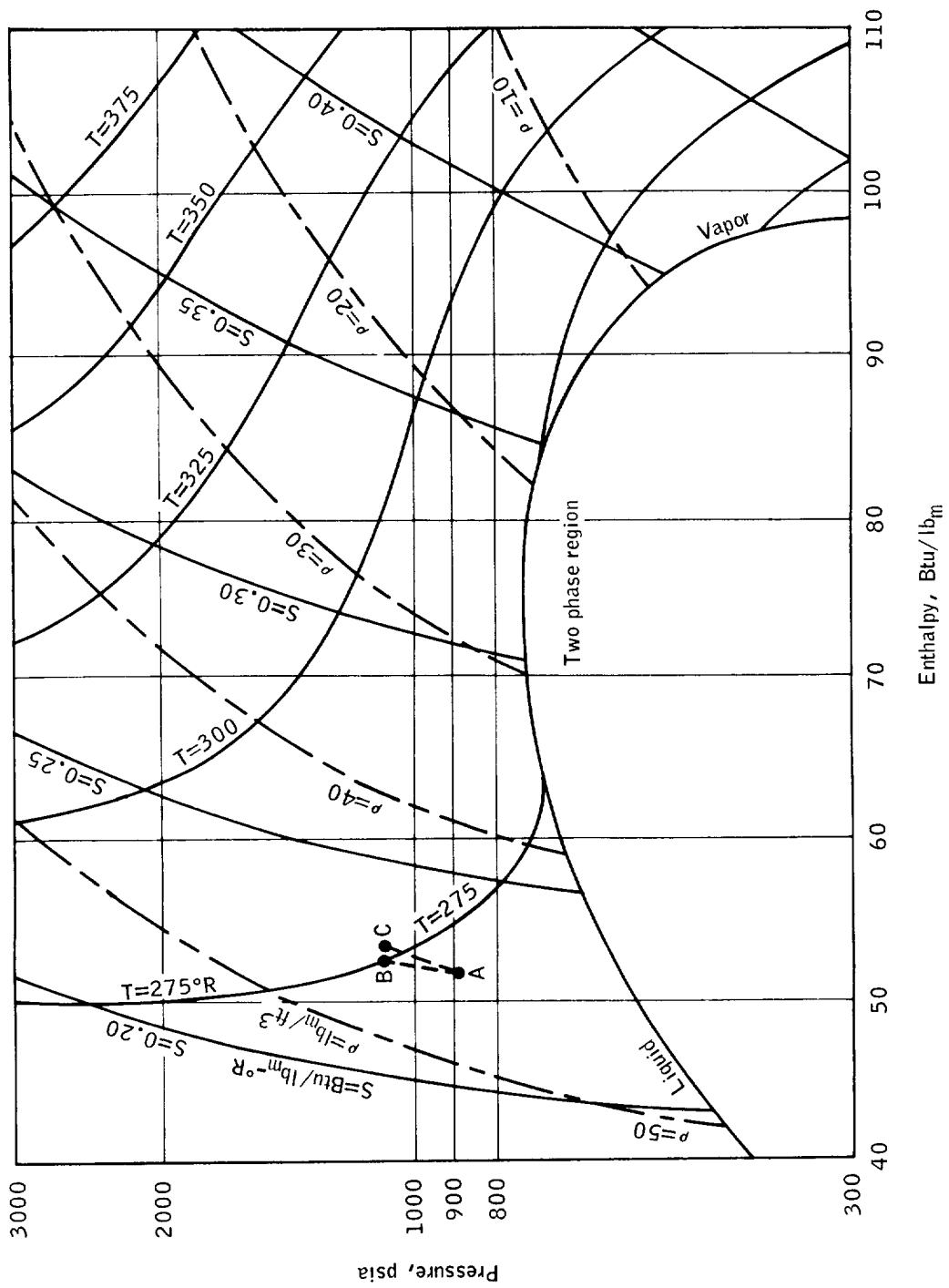

Figure F3.3-1.- Thermodynamic processes on pressure-enthalpy diagram.

either of the above-mentioned thermodynamic processes because they give a rise of only 1.8° and 2.6° F. As figure B5-3 shows, the measured temperature rise lagged the pressure rise. Both this lag and the magnitude of the temperature rise can be explained by the passage of a combustion front near the temperature sensor.

Energy Available in the Potentially Combustible Materials in the Tank

Many materials can of course react with oxygen if an ignition source is provided. Here only Teflon is considered in any detail while aluminum is mentioned briefly.

Teflon (polytetrafluoroethylene) can react with oxygen to form largely a mixture of carbonyl-fluoride, carbon tetrafluoride, carbon dioxide, and other species in small quantity, such as fluorine, depending on the stoichiometry and flame temperature. The overall chemical reactions which produce these combustion products include:

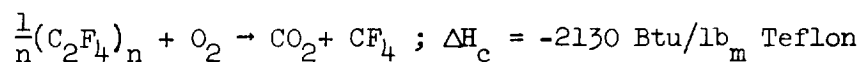
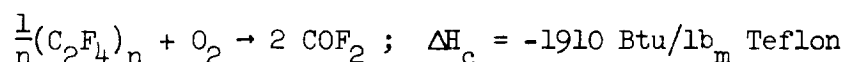

where the heat of combustion for these reactions is also given. For the purpose of this discussion, the heat of combustion of Teflon is taken to be -2000 Btu/lb_m Teflon. The internal energy of combustion ΔE_c is about 99 percent of ΔH_c. The amount of Teflon wire insulation in the system is about 0.13 lb_m, so that the energy available from combustion of Teflon wire insulation alone is about 260 Btu. This amount of energy is therefore more than sufficient to account for the measured pressure rise from 887 to 1008 psia.

If aluminum combustion occurs, or other tank components, the quantity of energy available is many times greater than the energy released by Teflon combustion. Experiments show that once ignited, aluminum burns readily with supercritical oxygen.

Potential Ignition Energy

Several experiments have shown that Teflon insulated wire can be ignited under the conditions that existed in the tank. A series of tests

has shown that the energy required to ignite Teflon in supercritical oxygen is 8 joules or less. It was also determined that ignition was geometry dependant and in one favorable configuration combustion was the fault initiated with an estimated energy as low as 0.45 joule. In any case, the value of 8 joules is less than energy deduced from the telemetry data, as will be shown below.

The fan motors were turned on just before the event occurred. There are clear indications of short circuiting in the fan motor circuitry immediately prior to the observed pressure rise. For the moment, we will consider ignition mechanisms by electrical arcing originating in the fan circuits as being the most probable cause of the fire.

An analysis has been made of the telemetry data that permits an estimate of the total energy that could have been dissipated in a postulated short circuit which ignited the Teflon. A summary of the analysis is presented here.

The following telemetry data were used in the analysis:

1. SCS thrust vector control commands. One hundred samples per second at 10-millisecond intervals. This channel provides, in effect, a time differentiated and filtered indication of phase C of ac bus no. 2 voltage.
2. Bus no. 2 ac phase A voltage. Ten samples per second at 100-millisecond intervals.
3. Fuel cell no. 3 dc voltage at 10 samples per second.
4. Total fuel cell current at 10 samples per second.

The 115-volt fan motor circuit is shown in figure D3-5 of Appendix D. The power for the motor comes from an inverter producing three-phase, 400-cycle, 115-volt power. The motors are operated in parallel, each phase to each motor being separately fused with a 1-ampere fuse (there are a total of six fuses in the circuit). The important portions of the telemetry traces are shown in figure F3.3-2. The sequence of events postulated is as follows:

1. Fan turnon occurs at 55:53:20 g.e.t. and the phase A voltage drops from 116.3 to 115.7 volts. This is normal. The telemetry granularity is ± 0.3 volt.
2. At 55:53:23, an ac voltage drop from 115.7 to 114.5 volts is observed, coincident with a fuel cell current increase of 11 amperes. This is the first short circuit that occurred after fan turnon. Since the ac voltage rose from 115.7 to 116.0 volts (as indicated by "togglng")

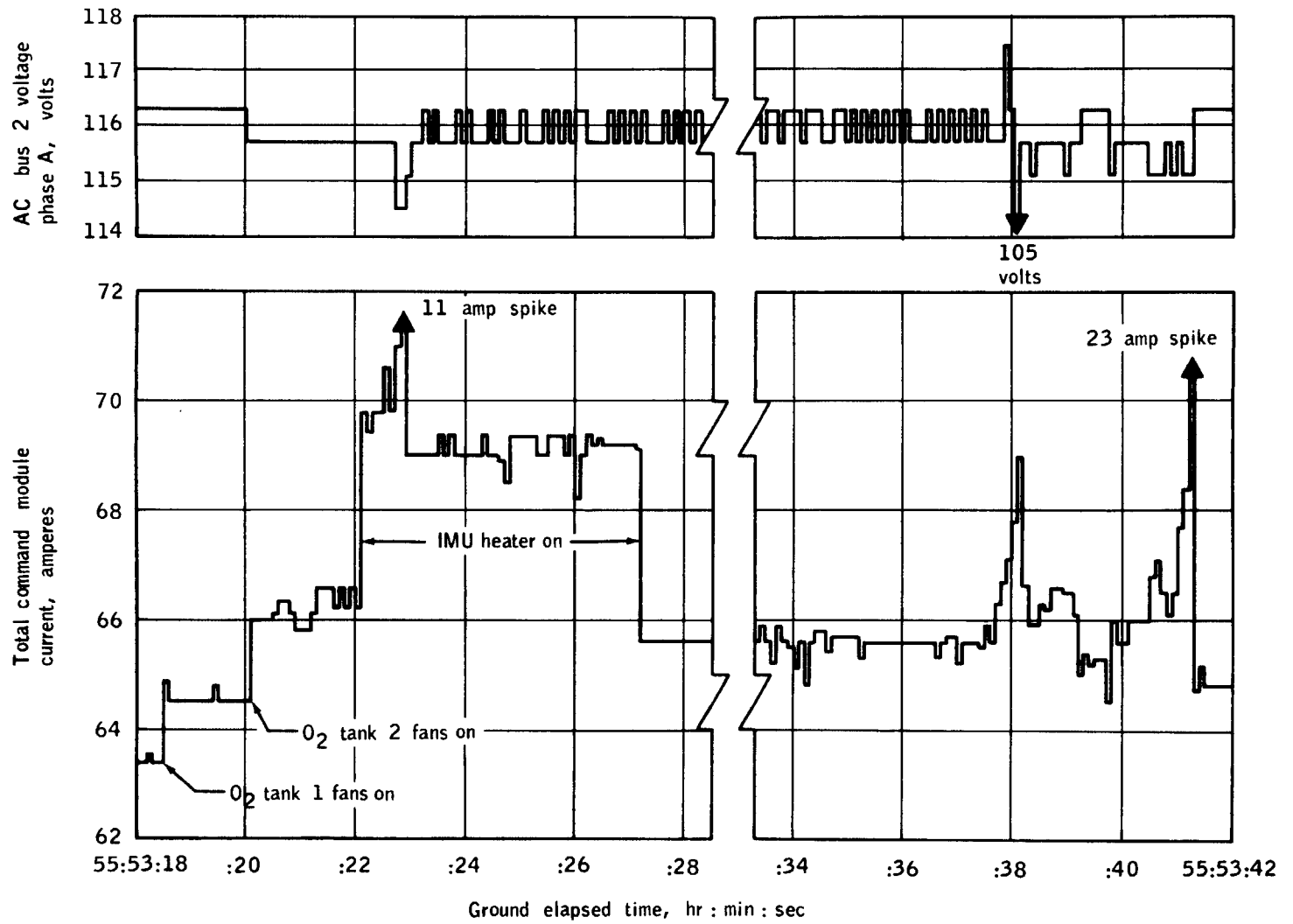

Figure F3.3-2.- Telemetry data for ac bus 2 voltage phase A and total CM current.

between 115.7 and 116.3 volts) after the event, it is probable that the short circuit involved phase A of the motor drive circuit, and all power may have been lost to one of the two fan motors at this time. This hypothesis is further supported by the coincident decrease in fuel cell current of 0.7 ampere, approximately half of the 1.5 amperes drawn by both motors.

3. At 55:53:38 another short circuit occurred, causing an ac voltage rise to 117.5 volts followed by a drop to 105 volts. The voltage rise indicates a short circuit in phase B or C as the regulator tries to bring up the voltage in a nonshorted phase. The 4-ampere dc current spike that occurs concurrently with this ac voltage rise and fall was probably much greater at some time between telemetry samples. The resultant decrease in phase A voltage may indicate an open circuit in one of the other phases of the second motor, causing phase A to draw more than normal current. The pressure in the tank starts to rise at 55:53:36 so that this short probably occurred after some combustion had commenced.

4. A final short circuit occurs at 55:53:41 as indicated by the 22.9-ampere spike on the dc current telemetry. No voltage drop is observed on the ac bus, probably because the short was of such short duration that it was not picked up by the telemetry samples. All the remaining fuses are blown (or the leads open-circuited) by this short circuit since the ac bus voltage and dc current return to the levels observed prior to initial energizing of the fans in oxygen tank no. 2.

The approximate total energy in the short circuit (arcing) can be estimated from the telemetry data. The voltage spikes indicate that the shorts were less than 100 milliseconds (the telemetry sampling interval) in duration. The fact that all the voltage and current "glitches" consisted of essentially one data point (sometimes none) means that the time of the short was very likely 50 milliseconds or less. An independent piece of evidence that bears on the time interval during which the short circuit condition exists comes from the signal on the SCS telemetry. A signal appeared on the SCS telemetry line each time a short circuit occurred on ac bus no. 2. These signals have a data rate 10 times larger than the signals from the ac and dc busses. The initial excursion of each of these SCS signals was 20 to 40 milliseconds long, and was then followed by one or two swings which are due to the SCS circuit filter characteristics. Thus, 30 milliseconds will be taken as an approximate value for the duration of the short circuits.

The current drawn during the short circuit can be estimated from the properties of the fuses used to protect the motor fan circuits. From April 18 to April 20, tests were conducted by MSC personnel to measure failure currents and failure times of the fuses using the same type inverter and fuses that were in the spacecraft. The following are the results of these measurements for a single-phase short circuit (data

taken from a preliminary report of table III of the MSC Apollo 13 Investigation Team):

Volts, ac	Amperes, ac	Duration, milliseconds	Fault energy, joules
107	3.0	120	39
105	4.0	31	13
102	5.0	20	10
95	7.0	10	7
75	9.0	8	5

From these results, the most probable range of ac current in the short circuit that occurred is 3 to 5 amperes. The total energy in the short circuit is therefore between 10 and 16 joules, since it is considered unlikely that the fault persisted for more than 50 milliseconds. Thus, a most probable energy of 13 joules and a most probable ac current of 4 amperes is reasonable for those faults which blew fuses.

These values are applicable to single-phase faults to ground. For two-phase faults, the current in each phase remains the same, while the available ignition energy doubles to 26 joules.

PART F3.4

TEFLON INSULATION IGNITION ENERGY TEST

Objective

To determine the energy required to ignite the Teflon insulation by 115 volt, 60 cycle sparks on flight-qualified wire which had been subjected to the type of heating which could have occurred during the KSC detanking procedure. The spark-generating circuit was fused so that it could deliver no more energy than could have been delivered by the fan motor circuit.

Approach

Sample sections of Teflon-insulated conductors obtained from Beech Aircraft Corporation through MSC were baked in oxygen for 5 hours at 572° F, held overnight at room temperature in oxygen, and baked further for 2 hours at 842° F. The Teflon lost its pliability, cracked, and flaked off as shown in figure F3.4-1.

The test specimen consisted of four strands of degraded-insulation wires, as shown schematically below.

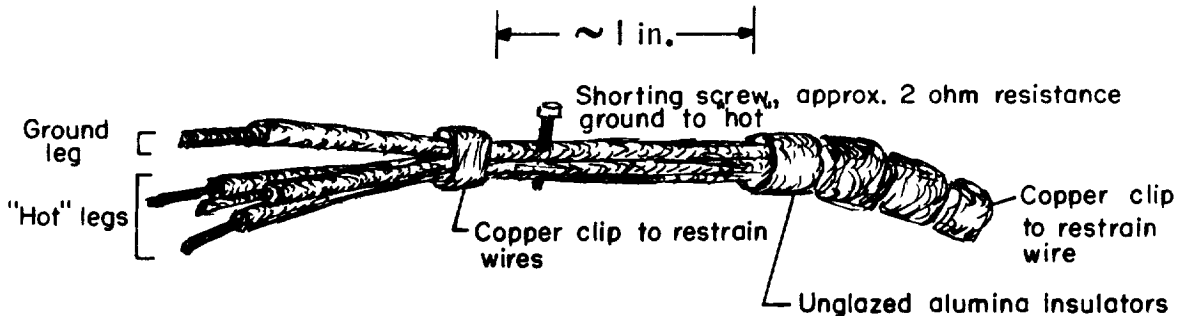

An adjustable short was provided by a number 80 screw driven between the strands of the "ground" wire and then adjusted so that a low-resistance short was established to one of the "hot" legs near some remaining Teflon. A replica of the test harness, made of virgin wire, is also shown in figure F3.4-1. The shorting screw and the standoff loop, installed to hold the screwhead away from the test-chamber walls, are seen in this photograph. The low resistance short was installed in series with a 1-ampere slow-blow fuse. In an independent test series, the current-carrying ability of this fuse was determined by inserting (in series) dummy resistors of various values to replace the shorted

F-20

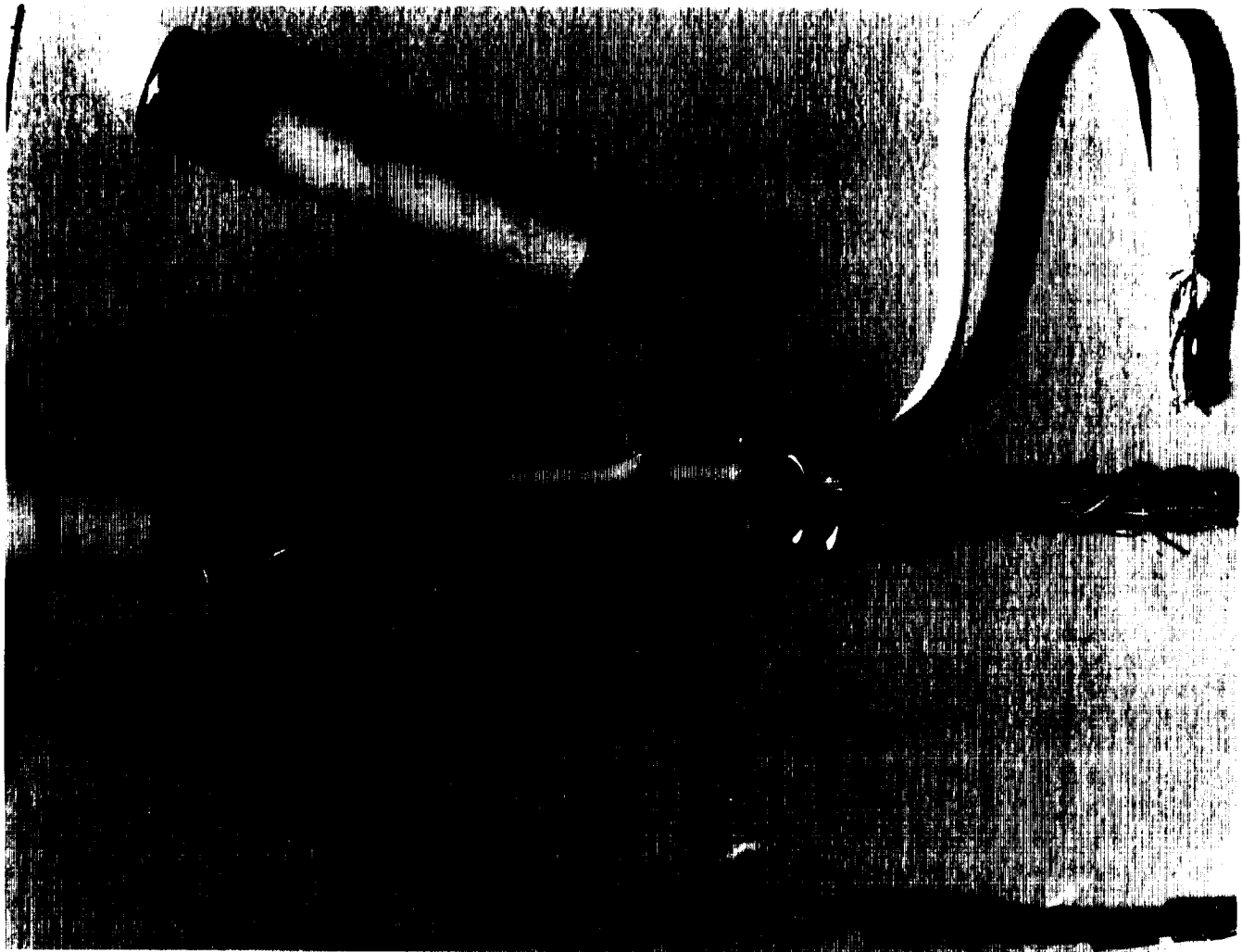

Figure F3.4-1.- Heat degraded wire and test harness replica.

test harness, and a 0.1-ohm resistor across which the voltage drop was measured. Repeated tests showed about 3.5 to 7.5 joules were required to destroy the fuse. Depending on the resistance of the remaining circuit, 10 to 90 percent of the line voltage might appear across the arc. The fault energy of the ignition tests, where the arc resistance is less than 2 ohms, is in the same range (i.e., from 3.5 to 7.5 joules).

The specimen was immersed in liquid oxygen (as before) inside the stainless steel tubing test rig shown in figure F3.4-2. The initial pressure was 920 psi.

Results

The test assembly withstood three firing pulses, 115 volts, 60 cycles, before igniting on the fourth. The 1-ampere fuse was blown each time. The short resistance was measured after each trial and was found to reduce progressively from about 5 ohms to 2 ohms, at which level ignition occurred on the next try. Approximately 1/2 second later the pressure gage showed the start of a 7-1/2 second pressure rise from 920 to 1300 psi. A thermocouple placed about 1 to 2 inches from the ignition point showed a small rise about 1 second after ignition and a large rise about 1/2 second later as the flame swept by. Much of the main conductor wire was consumed; all of the small thermocouple wire was gone. Virtually all of the Teflon was burned--Teflon residue was found only in the upper fitting where the electrical leads are brought into the test chamber. All but one of the alumina insulators vanished.

Conclusion

From the fuse energy tests and these ignition tests, it is clear that from 3.5 to 7.5 joules are adequate to initiate combustion of heat-degraded Teflon insulation. This is essentially the same as is required for unheated wire.



Figure F3.4-2.- Stainless steel test rig.

PART F3.5

IGNITION AND PROPAGATION THROUGH QUANTITY PROBE SLEEVE AND CONDUIT*

Objective

The purpose of this test was to determine if burning wire insulation would propagate through the upper quantity probe insulator. Another objective was to determine the failure mode of the conduit which results from the combustion of the polytetrafluoroethylene insulation.

Experimental

The chamber used for this test consisted of a schedule 80 weld-neck tee equipped with three flanges to provide a viewport, electrical and hard line feedthroughs, and conduit to quantity probe interface. The chamber, which is shown in figure F3.5-1, had a volume of approximately one-third cubic foot. A pressure relief valve was provided to maintain chamber pressure at 1050 psia during test; and, in addition, the chamber contained a rupture disc to prevent chamber failure. Supercritical conditions inside the chamber were obtained by filling with gaseous oxygen to a pressure of 940 psia and cooling externally with liquid nitrogen, using insulating foam covered with thermal blankets. Five thermocouple penetrations were provided through the chamber wall. Chamber pressure was monitored by a pressure transducer. Color motion pictures were taken through the chamber viewport at a speed of 24 frames a second. An additional camera provided external color motion pictures of the conduit-chamber interface.

The test item consisted of an upper portion of the quantity probe interfaced with a conduit assembly shown in figure F3.5-2. The quantity probe used was Block I hardware which had been sectioned for demonstration purposes. An additional hole was drilled in the probe insulator to modify it to Block II and wire was routed through it and the conduit assembly to represent the Apollo 13 configuration. Stainless steel sections were welded onto the probe to close the demonstration ports. Wiring with insulation was allowed to extend beyond the Teflon insulator approximately 4 inches. This wiring was also routed through the conduit and connected to the feedthrough pins through which power, 115 volts at 400 cycles, was supplied to both fan motor bundles by a system which had been

*Extracted from "Fuel Quantity Probe Sleeve and Conduit Assembly Flammability Report," prepared by the Manned Spacecraft Center for the Apollo 13 Review Board under TPS 13-T-06, June 5, 1970.

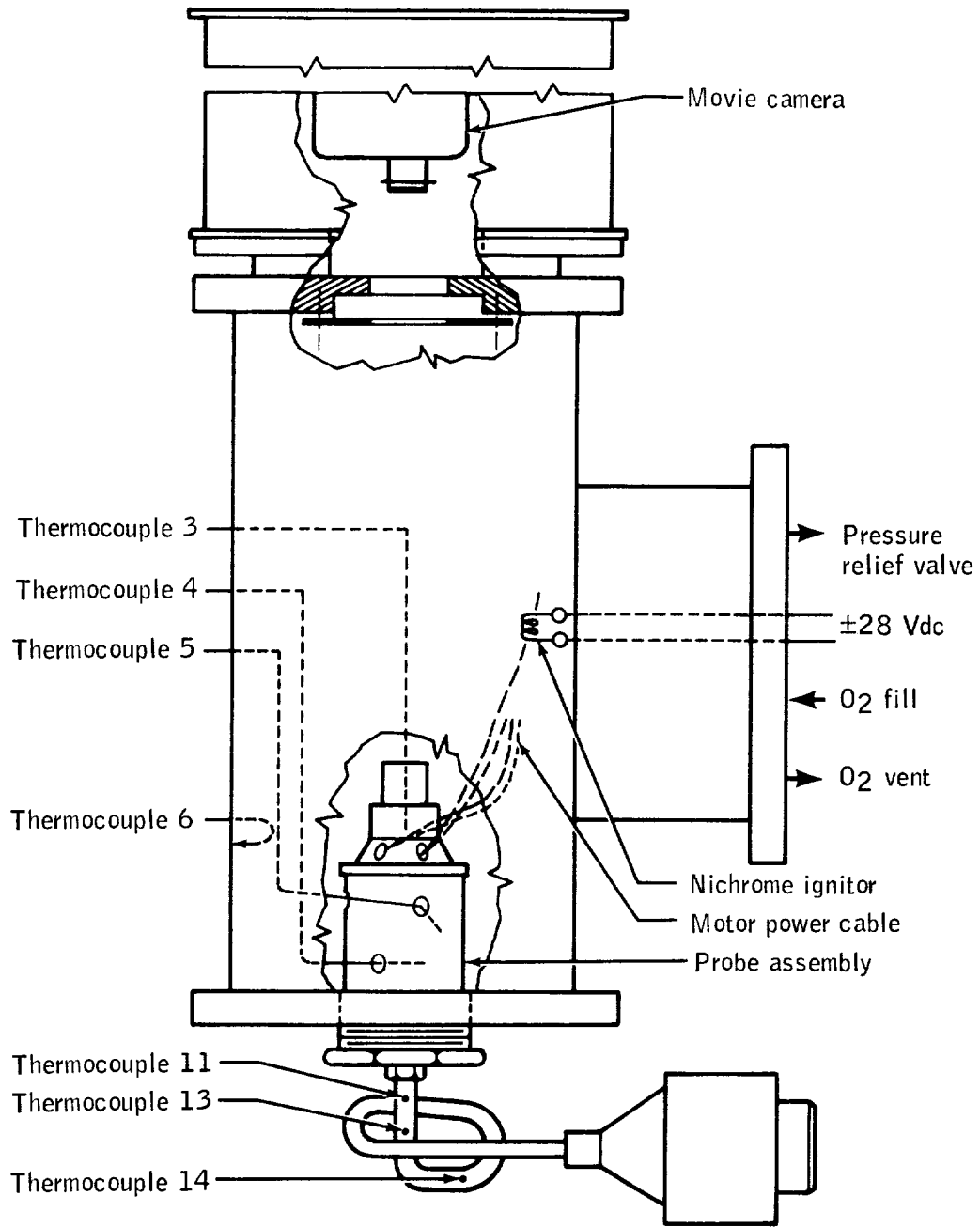

Note: Not to scale

Figure F3.5-1.- Quantity probe and conduit assembly apparatus.

fused using 1-amp fuses. One of the fan motor bundles was allowed to extend beyond the other wiring inside the test chamber and a nichrome ignitor was installed on it.

The probe conduit interface consisted of a stainless steel 2-inch pipe plug machined to the dimensions shown in figure F3.5-2. The interface was mounted on the bottom flange of the chamber so that flame propagation would be downward.

Three thermocouples were located in the region of the quantity probe as shown in figure F3.5-1. Two thermocouples were installed to measure internal chamber wall temperatures. Three thermocouples were installed on the external surface of the conduit as shown in figure F3.5-1.

After filling the chamber to 925 psia with gaseous oxygen, the chamber was cooled until thermocouple 3 shown on figure F3.5-1 indicated -138° F. Twenty-eight volts dc was applied at 5 amps to the ignitor for approximately 3 seconds. The current was increased to 10 amps for 2 seconds at which time fusion of the ignitor occurred.

Results

Pressure history of the chamber is shown in figure F3.5-3. The first relief valve opening occurred at approximately 28 seconds. It subsequently reopened 15 times before failure occurred. Fusion of the ignitor is shown on the graph to indicate ignition of the insulation.

Temperature histories of both internal and external portions of the test apparatus are shown in figures F3.5-4 and F3.5-5. Thermocouple placements in each of these areas are included in the legend figures of each of these graphs. It should be noted that two types of thermocouples were used, one with good sensitivity at low temperatures, copper-constantan, and one with good sensitivity at high temperatures, chromel-alumel. These two types are also indicated in figures F3.5-4 and F3.5-5.

The propagation observed in the color motion picture coverage internally proceeded from the ignition site (fig. F3.5-6) vertically downward. Figure F3.5-7 shows burning of the insulation on the fan motor wire bundle just before reaching the other wire bundles. Figure F3.5-8 shows the burning of several of the wire bundles. Figure F3.5-9 shows the burning of the wire bundles just prior to reaching the Teflon insulator, and figure F3.5-10 shows the more subdued fire after the propagation had progressed further into the upper probe region. Figure F3.5-11 shows the dense smoke after propagation of the burning into the insulator.

Figure F3.5-12 shows the conduit and chamber interface burnthrough scenes taken from the external movie coverage. The time for this sequence (24 frames) is 1 second. The small amount of external burning resulted

from ignition of the Mylar film used to insulate the test chamber.

Visual observation of the failure of the conduit through a test cell window revealed that a flame front resulted as far away as 3 or 4 feet from the chamber.

After the test, the section of conduit was found approximately 8 feet from the chamber. Several pieces of the Teflon insulator, two pieces of the conduit swedgelock nut, and one piece of conduit tubing were gathered from a 20-foot radius around the test area (fig. F3.5-13). The only item remaining in the test chamber was a portion of the Inconel section of the capacitance probe (fig. F3.5-14). The stainless steel portion was completely gone and a portion of the Inconel was burned. No remains of the aluminum portion of the probe could be found. The conduit-chamber interface was torched out to a maximum diameter of 1-7/8 inches (see figs. F3.5-15 and F3.5-16).

Conclusions

It is quite evident from the results of this test that the insulation burning on the electrical conductors did propagate through the probe insulator even in downward burning and proceeded into the conduit. It is difficult to determine if the insulator was ignited and what time was required for the burning to propagate through the insulator. However, failure of the conduit occurred in approximately 10 seconds after burning had proceeded to the insulator-wire bundle interface. After the initial failure of the conduit, the contents of the tank (1/3 cubic foot) were vented in approximately 0.5 second with a major portion of the burning of metal occurring in 0.25 second. Venting of larger amounts of oxygen would not necessarily take longer since continued oxygen flow should produce considerably larger "torched out" sections. In order to produce the heat necessary for the effects observed here, metal burning must have occurred.

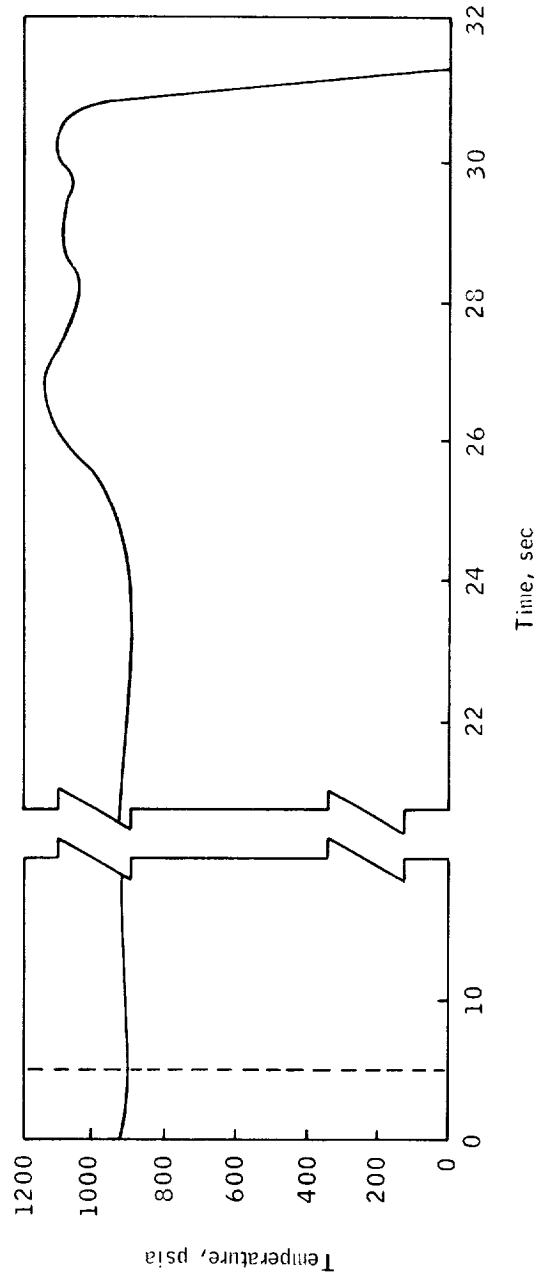

Figure F3.5-3.- Quantity probe and conduit assembly test pressure history.

F-29

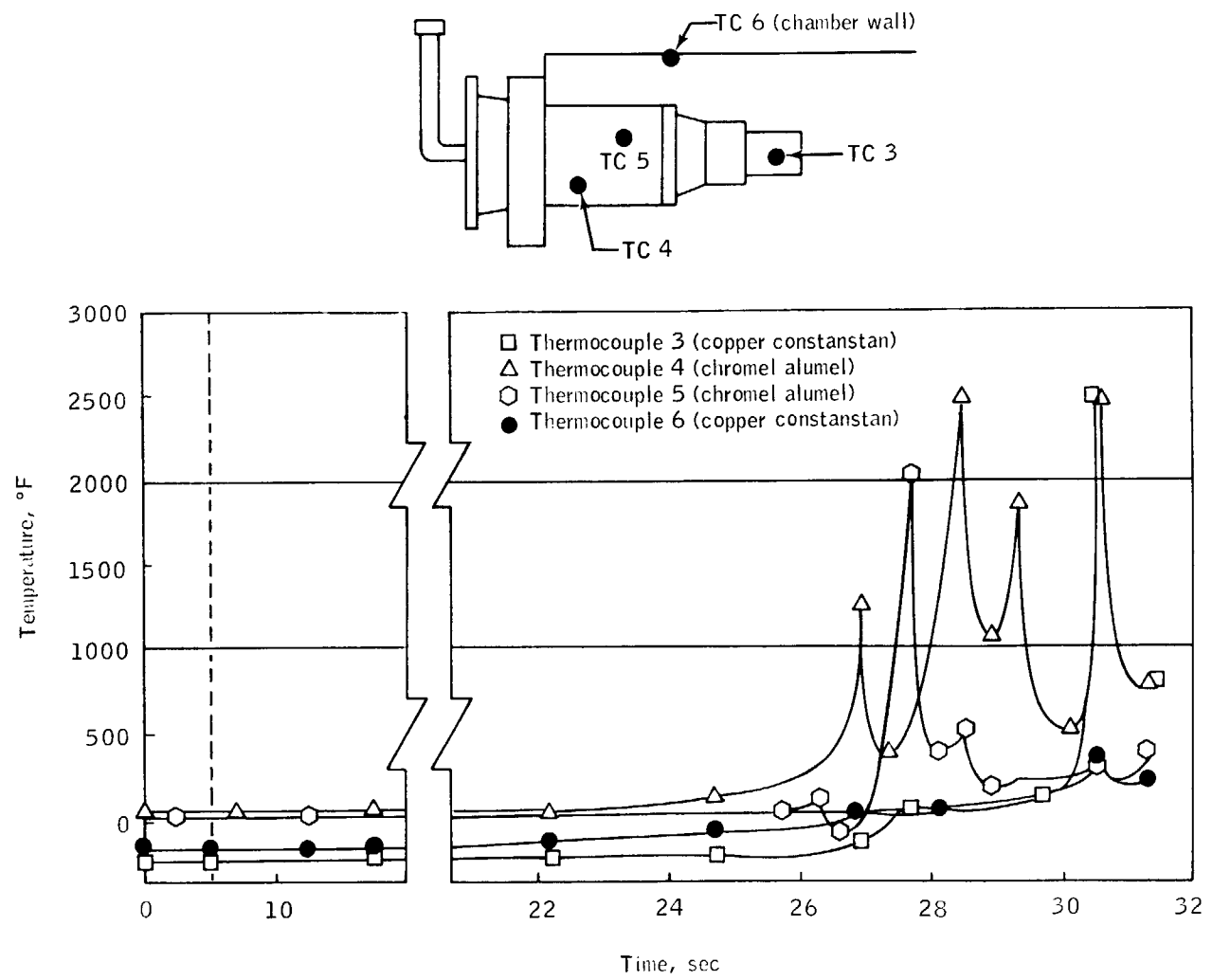

Figure F3.5-4.- Temperature history of quantity probe and chamber wall.

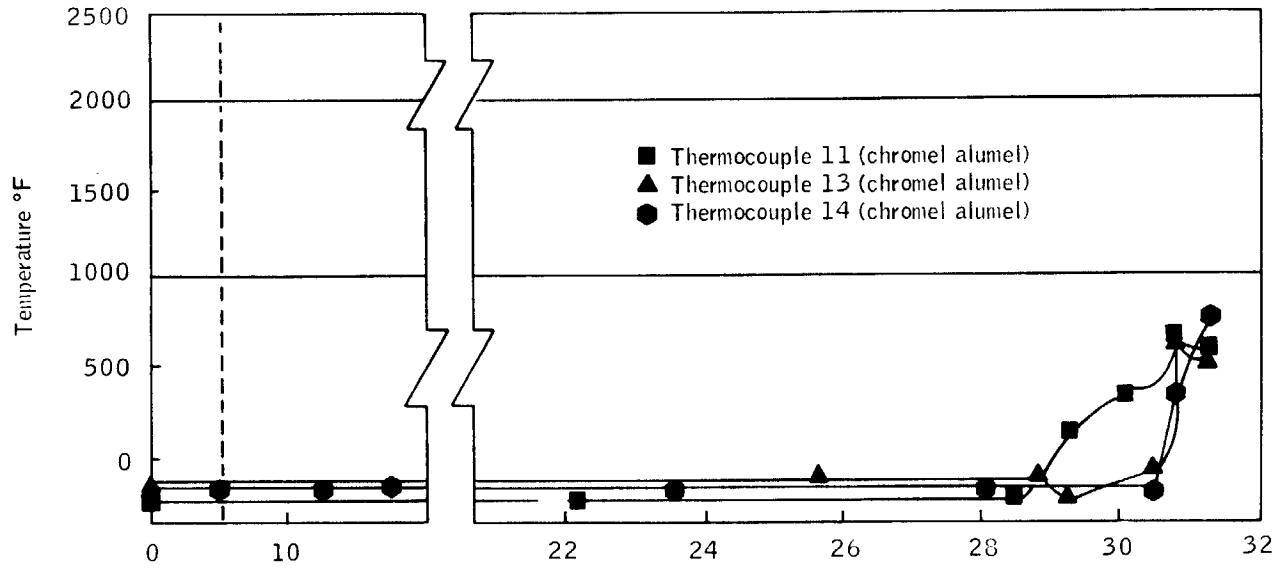
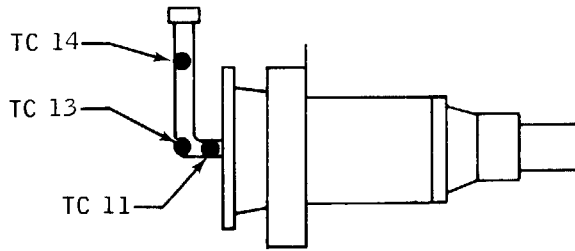

Figure F3.5-5.- Temperature history of conduit.

F-31

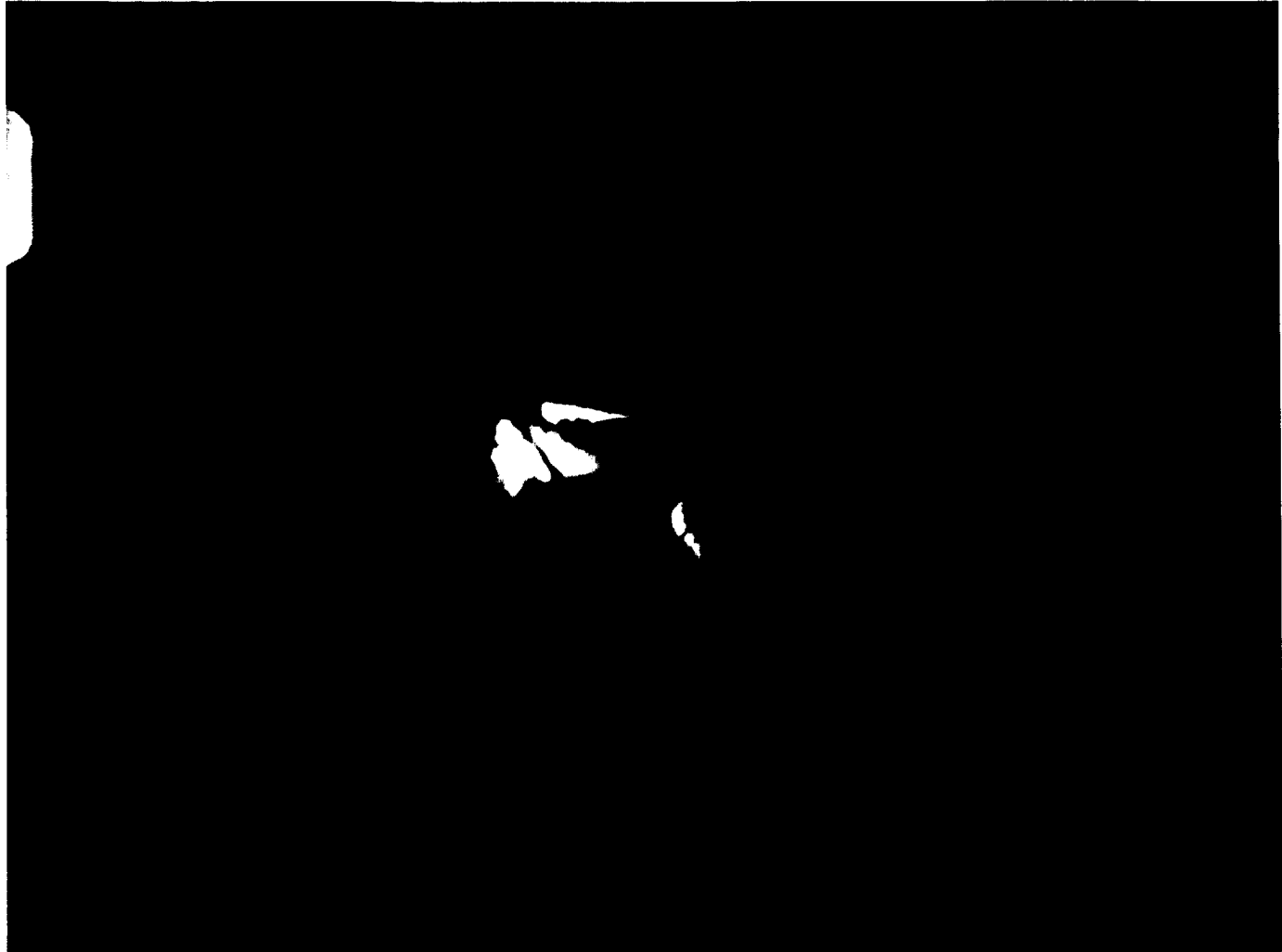

Figure F3.5-6.- Internal chamber view shortly after ignition.

F-32

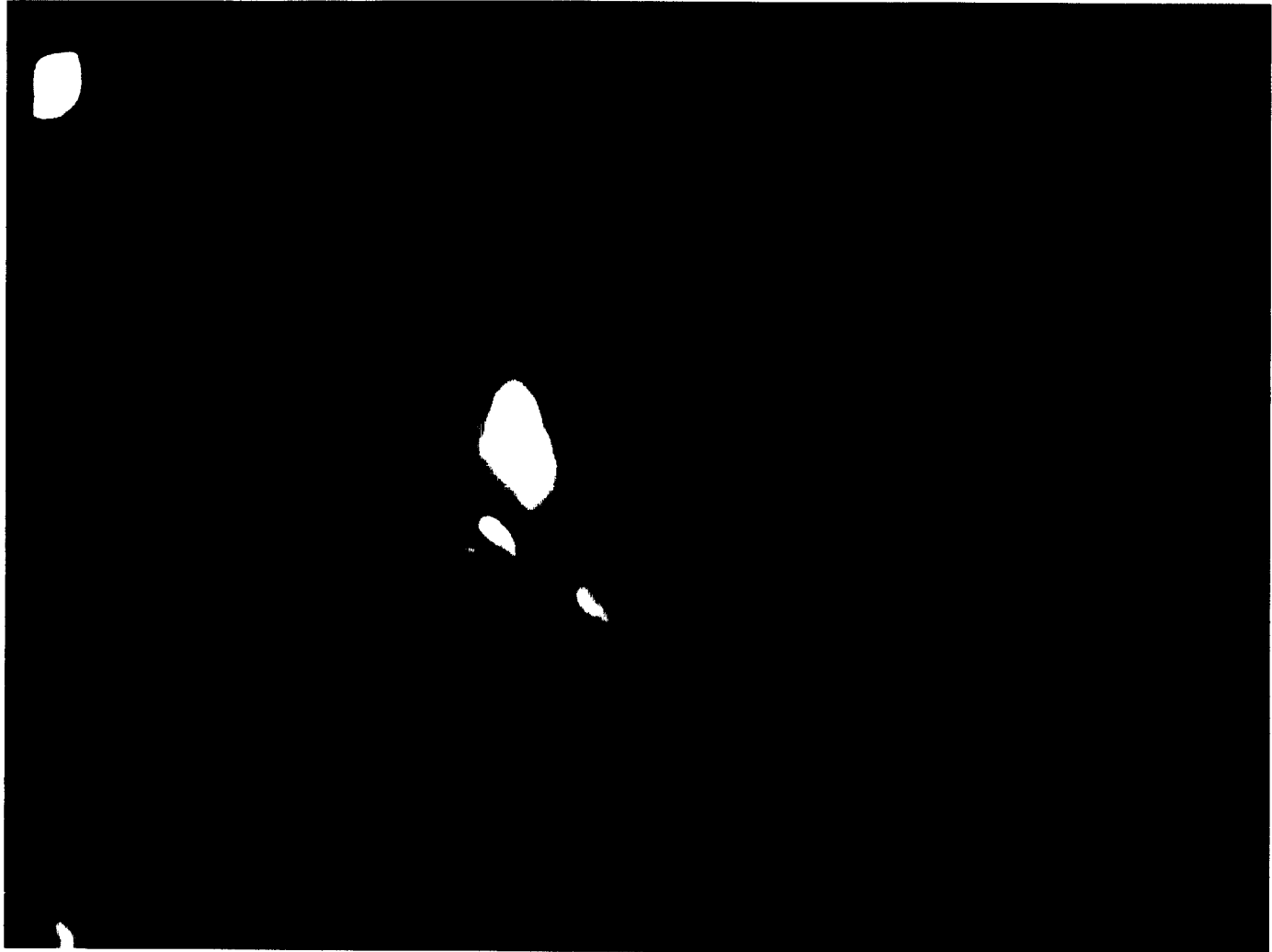

Figure F3.5-7.- Burning along fan motor wire bundle.

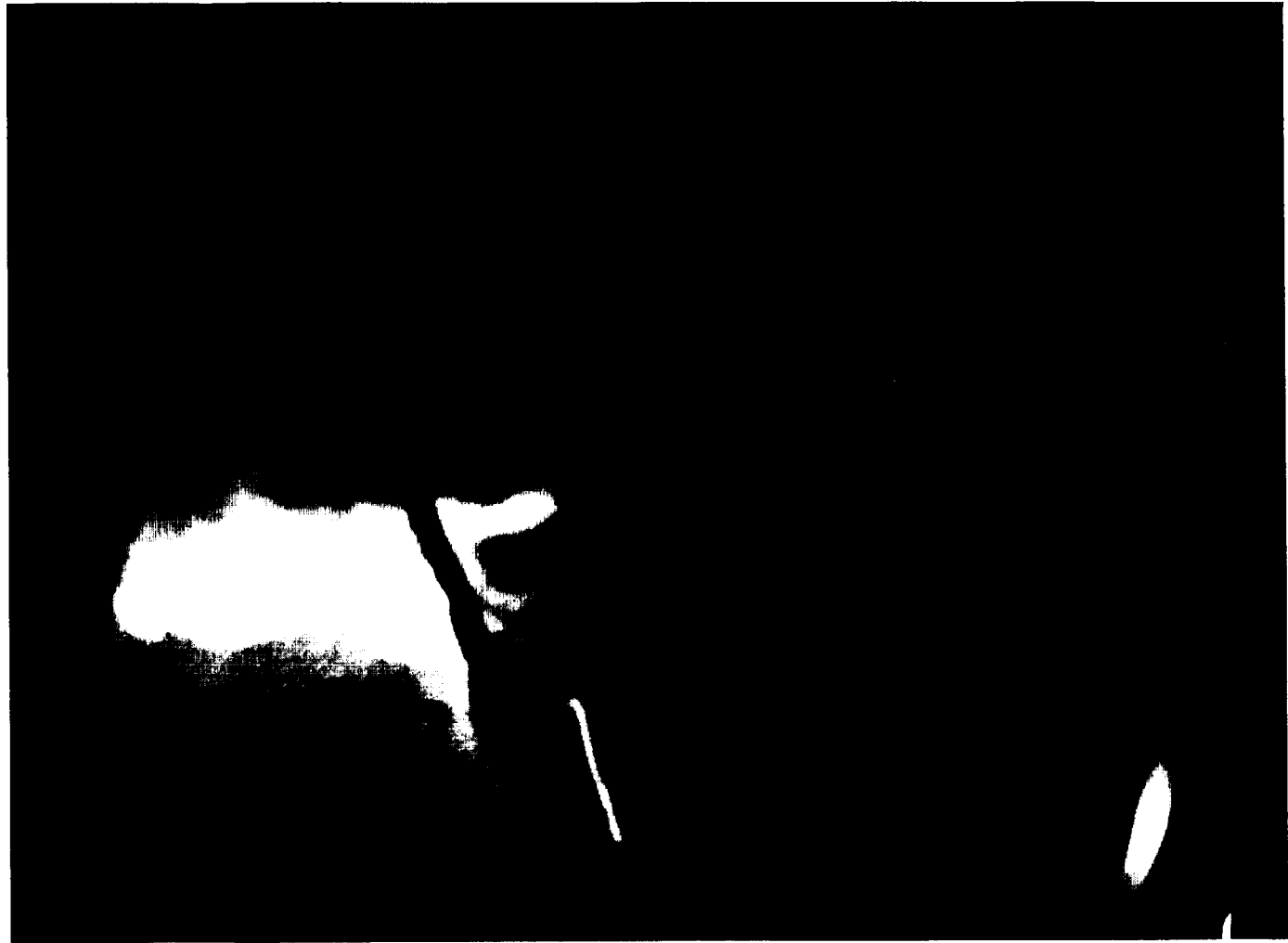

Figure F3.5-8.- Burning of adjacent wire bundles.

F-34

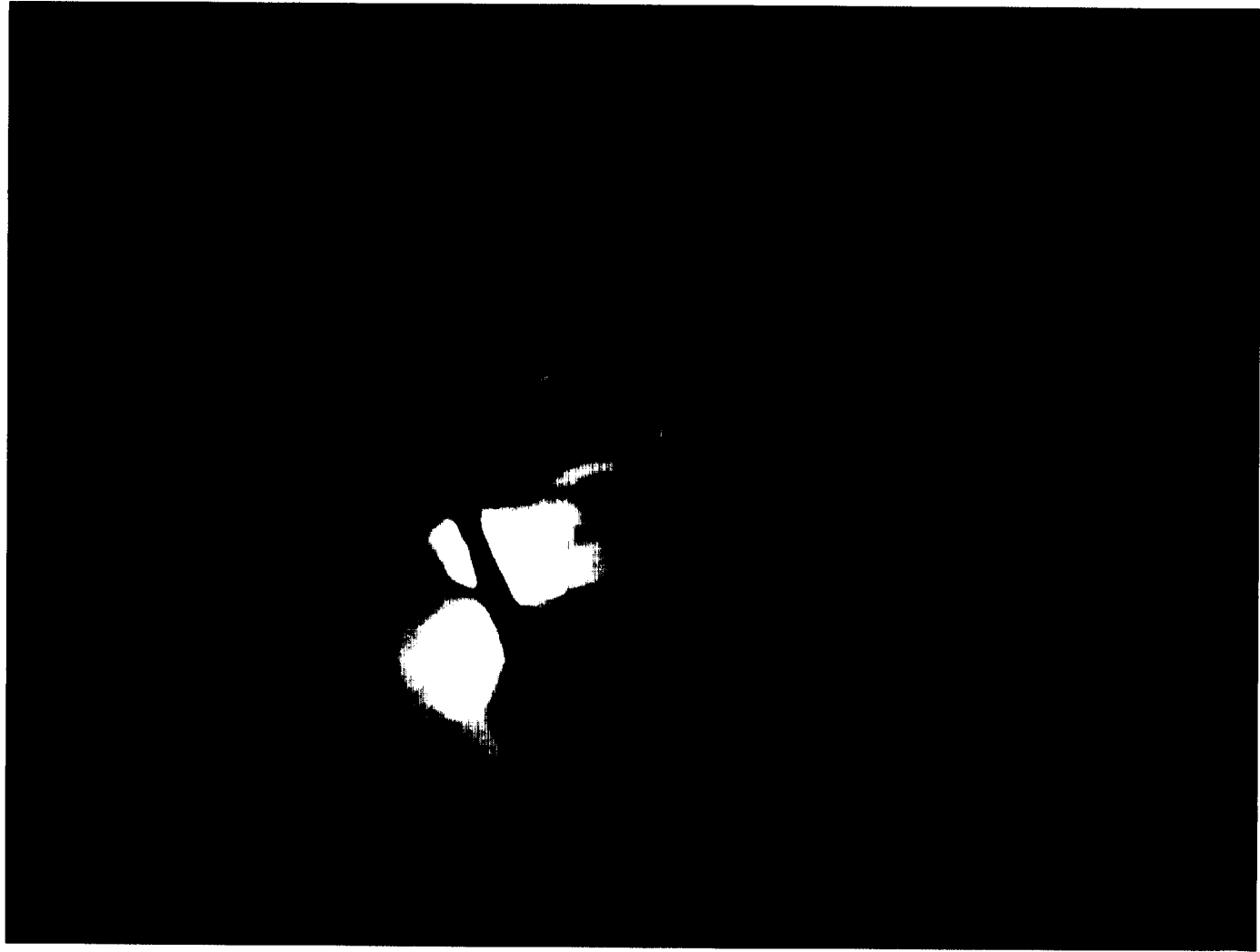

Figure F3.5-9.- Burning bundles prior to reaching probe insulator.

F-35

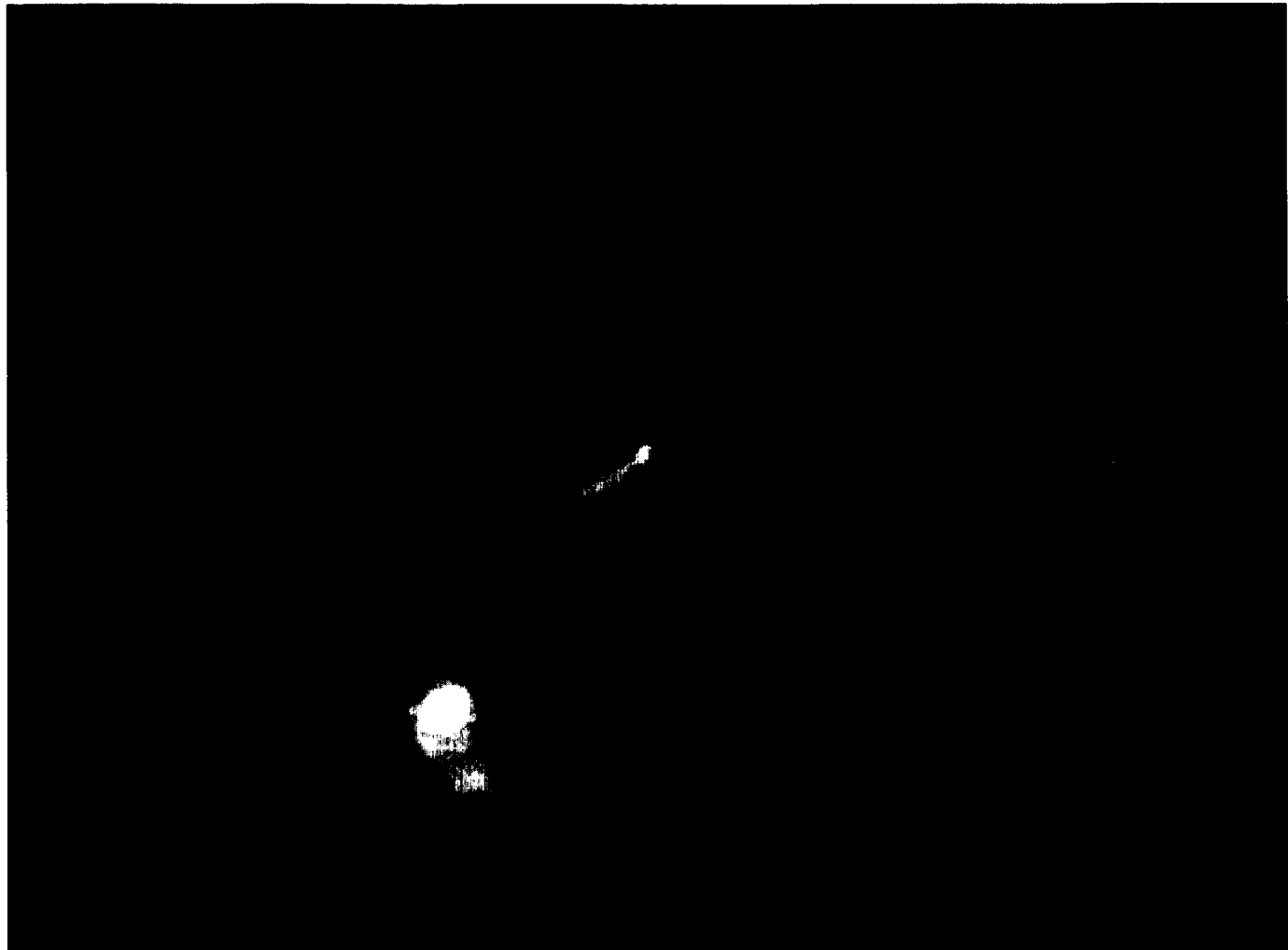

Figure F3.5-10.- Burning progressed into insulator.

F-36

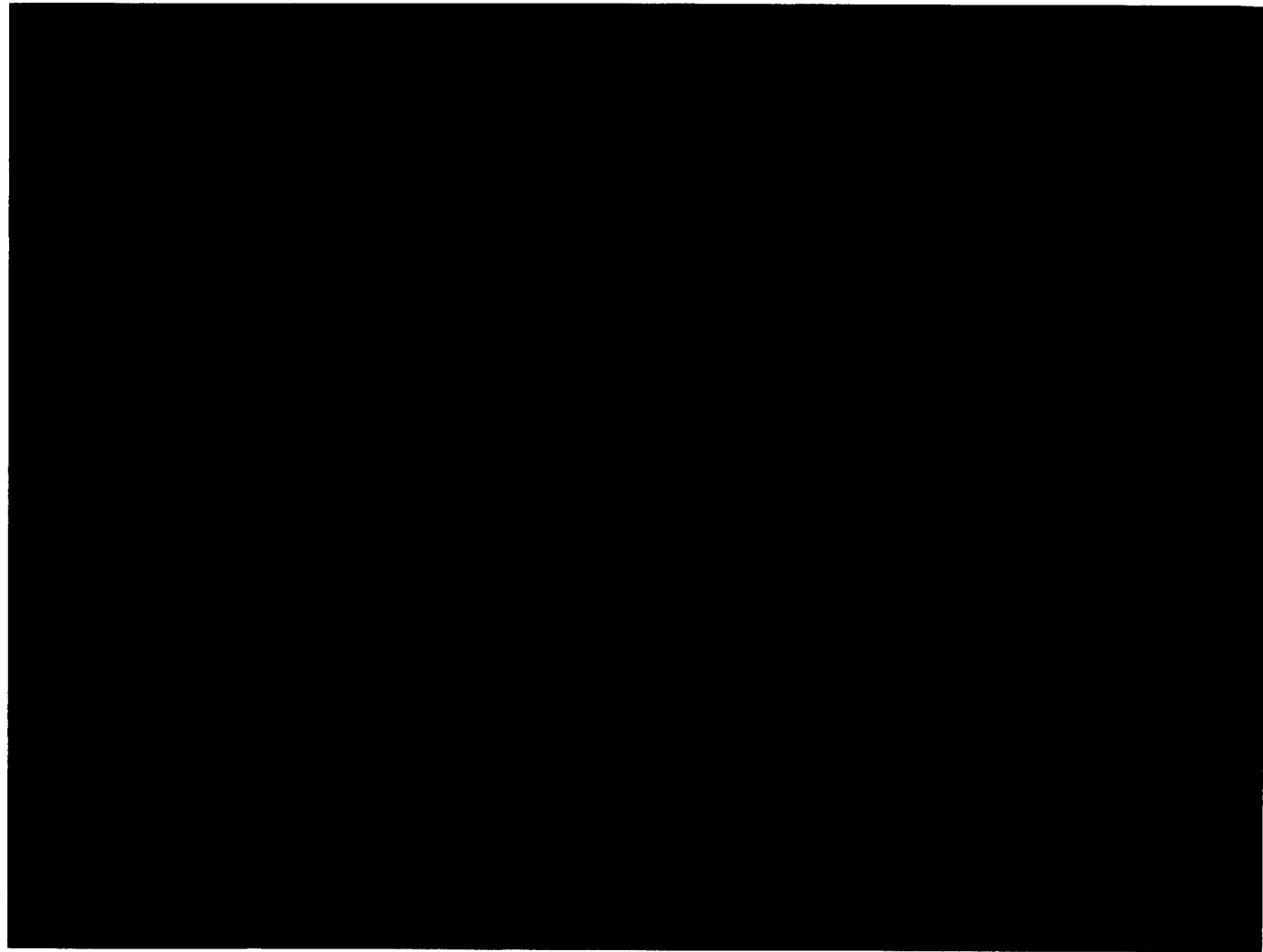

Figure F3.5-11.- Dense smoke after propagation of burning into insulator.

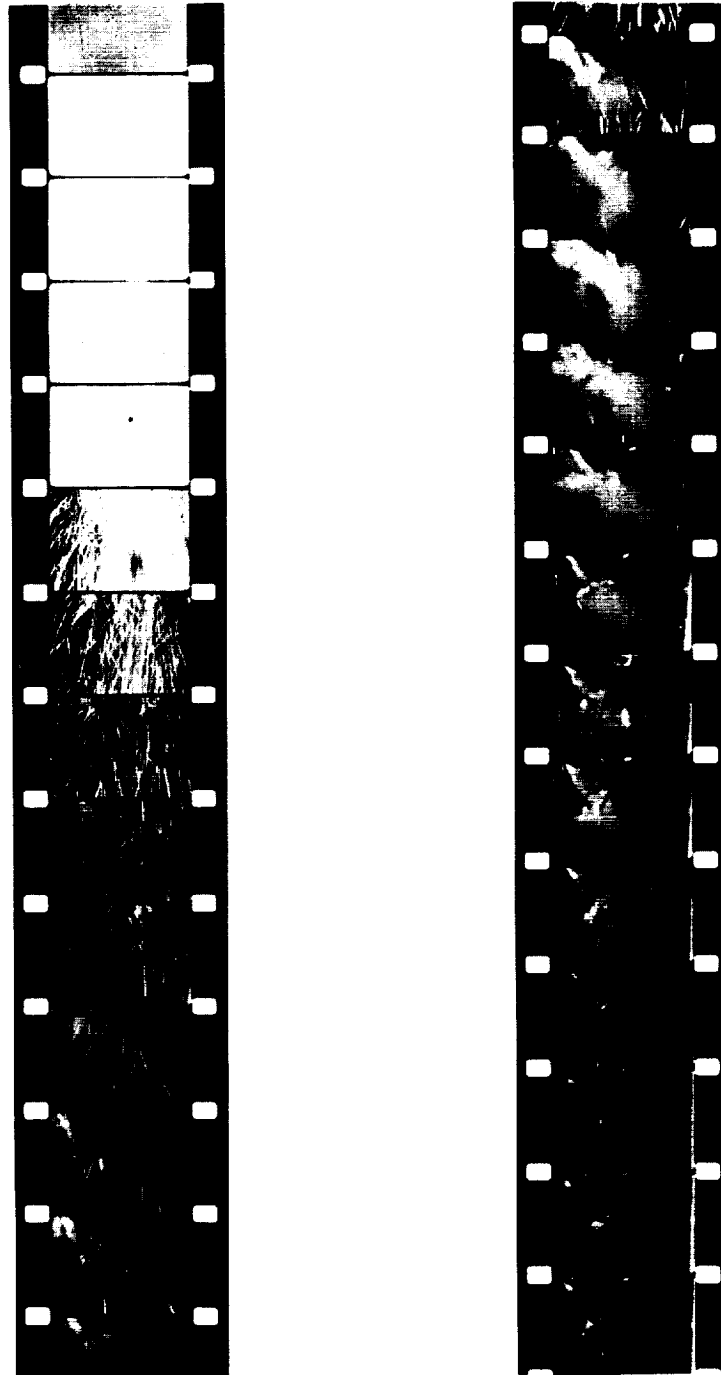

Figure F3.5-12.- External views of chamber-conduit interface at time of failure.



Figure F3.5-13.- Parts of probe insulator and tubing collected from area around test chamber.



Figure F3.5-14.- Portion of probe which remained in the test chamber.



Figure F3.5-15.- External view of chamber flange on which conduit-quantity probe interface was mounted (after test).



Figure F3.5-16.- View of chamber flange internal surface after test.

PART F3.6

ZERO-g TEFLON FLAME PROPAGATION TESTS

Objective

The objective of these tests was to measure the flame propagation rate along Teflon-insulated wire bundles in oxygen at 900 psia and -180° F in a zero-g environment. A second objective was to determine whether flames travelling along the fan motor lead wires would pass through the aperture in the motor case. Measurements are to be used to interpret the pressure and temperature history observed in the oxygen tank during the accident.

Apparatus

Tests were conducted at the Lewis Research Center's 5-Second Zero Gravity Facility. An experimental apparatus was designed and constructed which permitted the tests to be conducted in an oxygen environment of $920 \text{ psia} \pm 20 \text{ psi}$ and $-180^{\circ} \text{ F} \pm 10^{\circ}$. The apparatus was installed on a standard drop test vehicle capable of providing the necessary supporting functions. An overall view of the drop vehicle is presented in figure F3.6-1 and a detailed photograph of the experimental apparatus is shown in figure F3.6-2. The basic components of the experimental apparatus are the combustion chamber with a sapphire window to permit high-speed photography, and an expansion tank as a safety feature in the event an excessive pressure rise were to occur. The apparatus was equipped with a fill and vent system, pressure relief system, and liquid nitrogen cooling coils. The test specimen was installed in the combustion chamber in a horizontal position as is shown in figure F3.6-3. This figure is typical of all installations. Ignition was caused by heating a 26-gage nichrome wire which was wrapped around the specimen. Chamber pressure and temperature were monitored throughout the test. High-speed photographic data (400 frames per second) were obtained using a register pin Milliken camera.

Approach

A total of eight tests were conducted on three test specimens. Each specimen was run in a one-g and a zero-g environment, and a one-g and zero-g test was repeated on two specimens to examine repeatability of the data. The three specimens were the following:

Type 1 - Fan motor conductor bundle - four wires and white sleeving

Type 2 - Fan motor conductor bundle - four wires and clear shrink sleeving

Type 3 - Aluminum Teflon feed-through assembly - four wires and no sleeving

The aluminum plate thickness for the Type 3 tests equaled that of the fan motor case. This specimen was used to determine whether a flame burning along the lead wires would continue through the aperture in a simulated motor case, and whether the aluminum would ignite.

Results

The zero-g linear propagation rate for fan motor wires in white pigmented Teflon sleeving (Type 1) was measured as 0.12 in/sec, and for the same wires in clear Teflon sleeving (Type 2), the rates in two separate tests were 0.16 and 0.32 in/sec. The corresponding flame propagation rate at one-g for both types of wire bundles was 0.55 in/sec measured in three tests. These results are listed in table F3.6-I. The flame in both zero-g and one-g tests pulsed as it spread along the wire bundles with the flame markedly more vigorous in the one-g cases. In all cases the Teflon was completely burned with little visible residue.

The flame propagation tests through an aluminum plate (Type 3) showed that the flame did not appear to have propagated through the Teflon grommated aperture under zero-g conditions, but did pass through at one-g. Unfortunately, the pictures of the flames under zero-g were not clear enough to be certain that the flame failed to propagate through the aperture. Because the zero-g period lasts for less than 5 seconds following ignition, it is possible that flame propagation through the aperture would have been observed if more time at zero-g were available. These results are also listed in table F3.6-I.

Conclusions

The flame propagation rate along Teflon insulation in zero-g is reduced by about a factor of two from that observed in one-g. The propagation rate along the fan motor lead bundle in zero-g is in the range of 0.12 to 0.32 in/sec. These flame propagation rates are of a magnitude which is consistent with the time required to account for the duration of the pressure rise in the spacecraft oxygen tank.

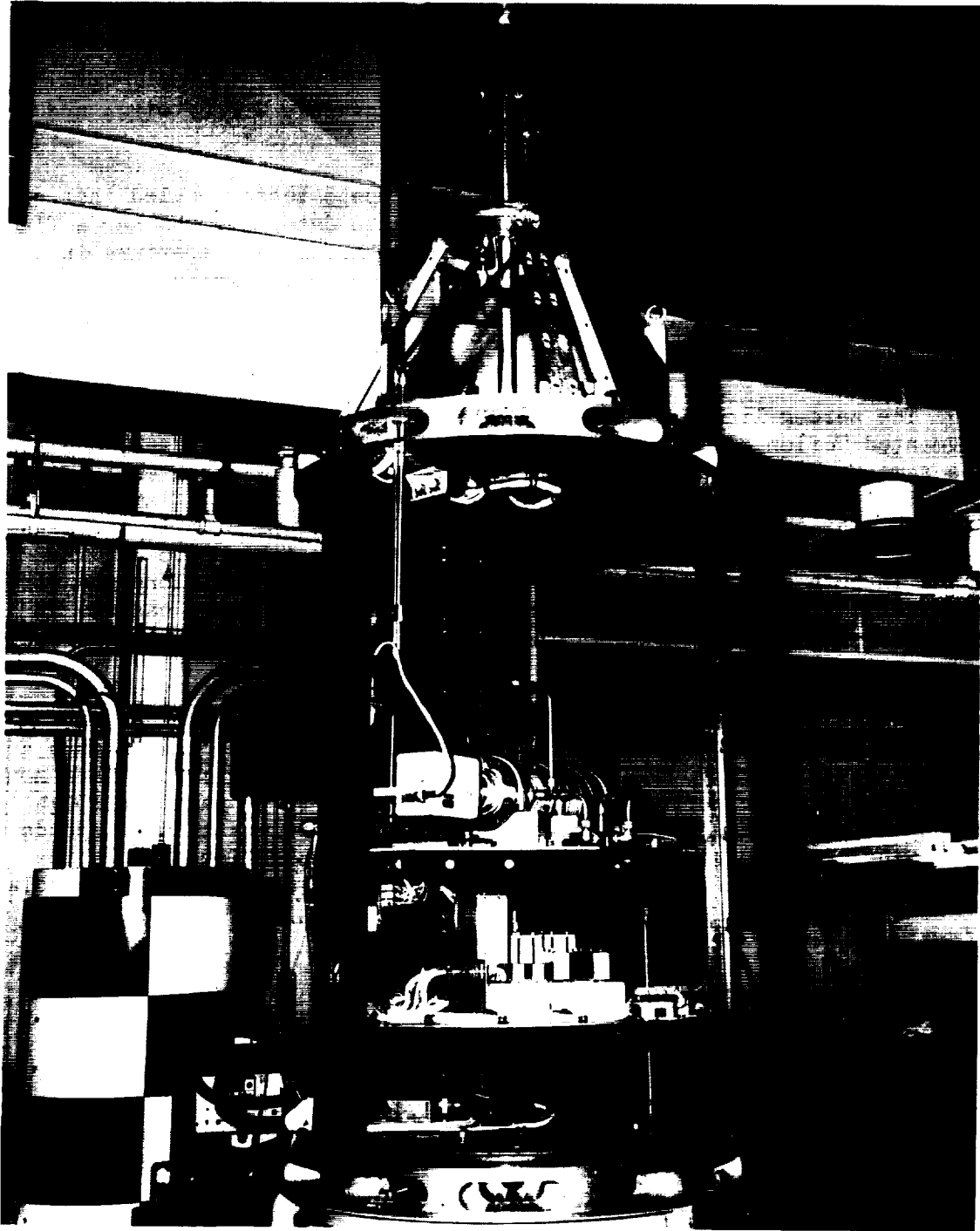

Figure F3.6-1.- 5-second drop vehicle.

F-45

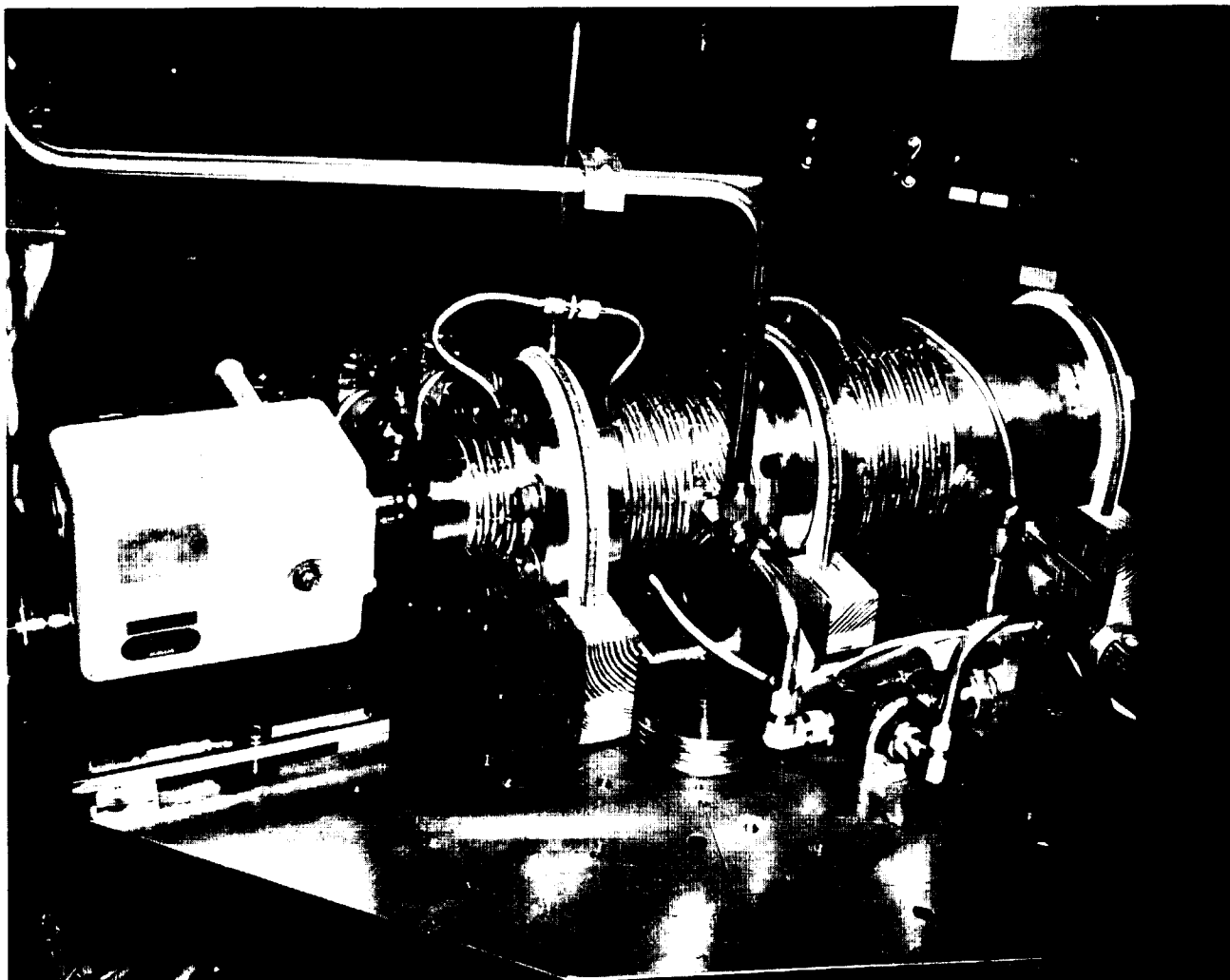

Figure F3.6-2.- Experimental combustion apparatus.

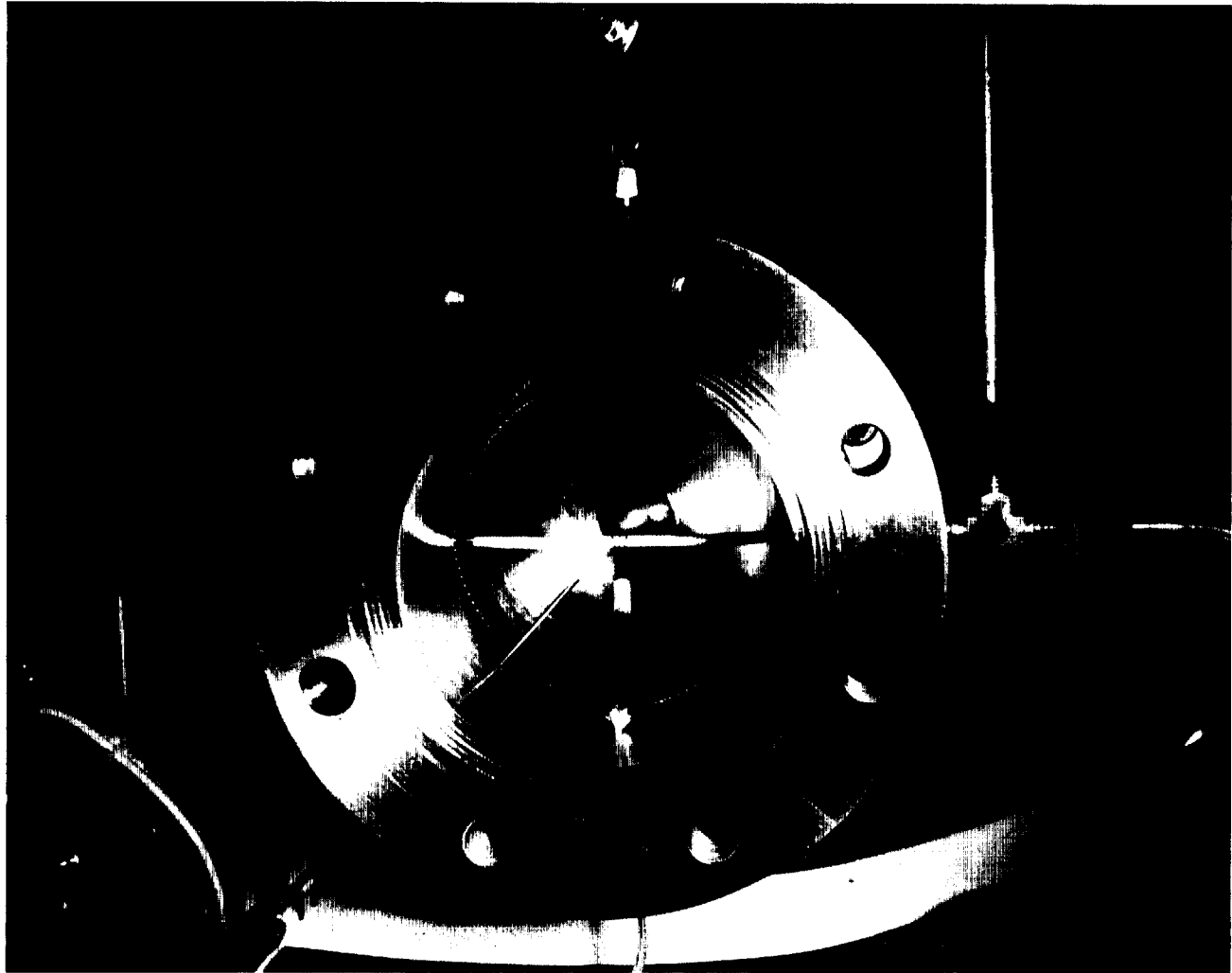

Figure F3.6-3.- Typical test specimen installation in combustion chamber.

TABLE F3.6-I.- SUMMARY OF RESULTS

Run no.	Test specimen	Gravity level	Average flame spread rate, in/sec	Comments
A-1-1	Type 1	One	0.55	The specimens burned vigorously. The flame progressed along the specimens in a pulsating fashion.
A-1-2	Type 2	One	0.55	
A-1-6	Type 1	One	0.55	
A-1-3	Type 2	Zero	0.16	The specimens burned in zero-g but not as vigorously as in normal gravity. The flame pulsated along the specimens in a similar way as in normal gravity but at a slower overall rate.
A-1-5	Type 1	Zero	0.12	
A-1-7	Type 2	Zero	0.32	
A-1-8	Type 3	One	-	The flame propagated through the aluminum holder but did not ignite it.
A-1-4	Type 3	Zero	-	The flame could not be clearly defined on the film. The aluminum holder did not ignite.

PART F3.7

FULL-SCALE SIMULATED OXYGEN TANK FIRE

Objectives

The purpose of this test was to simulate as closely as possible, in a one-g environment, the processes that occurred during the failure of oxygen tank no. 2 of Apollo 13. The data to be obtained include the pressure and temperature history which results from the combustion of Teflon wire insulation beginning at one of three likely ignition locations, as well as observing the manner in which the tank or conduit fails and vents its contents.

Apparatus

A Block I oxygen tank was modified to Block II configuration. The vacuum dome was removed and the tank was mounted in a vacuum sphere with the appropriate size and length of tubing connected. The heaters were disconnected and three hot-wire ignitors were installed. One ignitor was located on the bottom fan motor leads, one on the top fan motor leads, and another on the wire loop between the quantity probe and the heater-fan support. The connecting tubing, filter, pressure transducer and switch, relief valve, and regulator were flight-qualified hardware. The tank was mounted so that the long axis of the quantity probe was horizontal. Figure F3.7-1 shows the tank mounted in the chamber. Two television cameras and four motion picture cameras were mounted in the vacuum chamber. One camera operates at 64 frames/sec, two at 250 frames/sec, and another at 400 frames/sec. The two 250 frames/sec cameras were operated in sequence.

Results

The nichrome wire ignitor on the bottom fan motor leads was ignited. The tank pressure rose from an initial value of 915 psia to 990 psia in 48 seconds after ignition. The temperature measured by the flight-type resistance thermometer, mounted on quantity gage, rose 3° F from an initial value of -202° to -199° F in this 48-second period. The tank pressure reached approximately 1200 psia at 56 seconds after ignition and apparently the flight pressure relief valve which was set to open at 1005 psia could not vent rapidly enough to check the tank pressure rise. Two GSE pressure relief valves, set at higher pressures, apparently helped to limit the tank pressure to 1200 psia. The tank temperature rose abruptly after 48 seconds, following ignition, from -199° to -170° F in 3 seconds. After this time the temperature read off-scale above

2000° F. Failure of the temperature measuring wiring is indicated by the erratic readings that followed. These data are shown in figure F3.7-2. The pressure data shown beyond 56 seconds represent the venting of the tank contents. These pressure and temperature histories are qualitatively similar to the measured flight data but occur more rapidly than observed in flight.

The conduit failed close to where it attaches to the tank closure plate about 57 seconds after ignition (fig. F3.7-3). The two 250-frame/sec cameras and the 64-frame/sec camera failed to operate during this test. However, the 400-frame/sec camera suggests that the first material to issue from the ruptured conduit was accompanied by bright flame. The tank pressure declined from 1175 psia to 725 psia in 1 second following conduit rupture. High oxygen flow rates were observed from the conduit breach for about 15 seconds. A posttest examination of the ruptured conduit showed that the expulsion of the tank contents was limited by the 1/2-inch-diameter aperture in the tank closure plate. An examination of the internal components of the tank showed complete combustion of the Teflon insulation on the motor lead wires as well as almost complete combustion of the glass-filled Teflon sleeve. This is shown in figure F3.7-4.

Conclusions

The qualitative features of the pressure and temperature rises in oxygen tank no. 2 have been simulated by initiating Teflon wire insulation combustion on the lower fan motor lead wire bundle. The time from ignition of the total combustion process in the simulated tank fire is about three-fourths to one-half the time realized in the spacecraft accident. The conduit housing the electrical leads failed near the weld and resulted in a limiting exit area from the tank of about 1/2 inch diameter. The venting history is characteristic of the expulsion of liquid for the first 1-1/2 seconds. This was followed by a two-phase flow process.

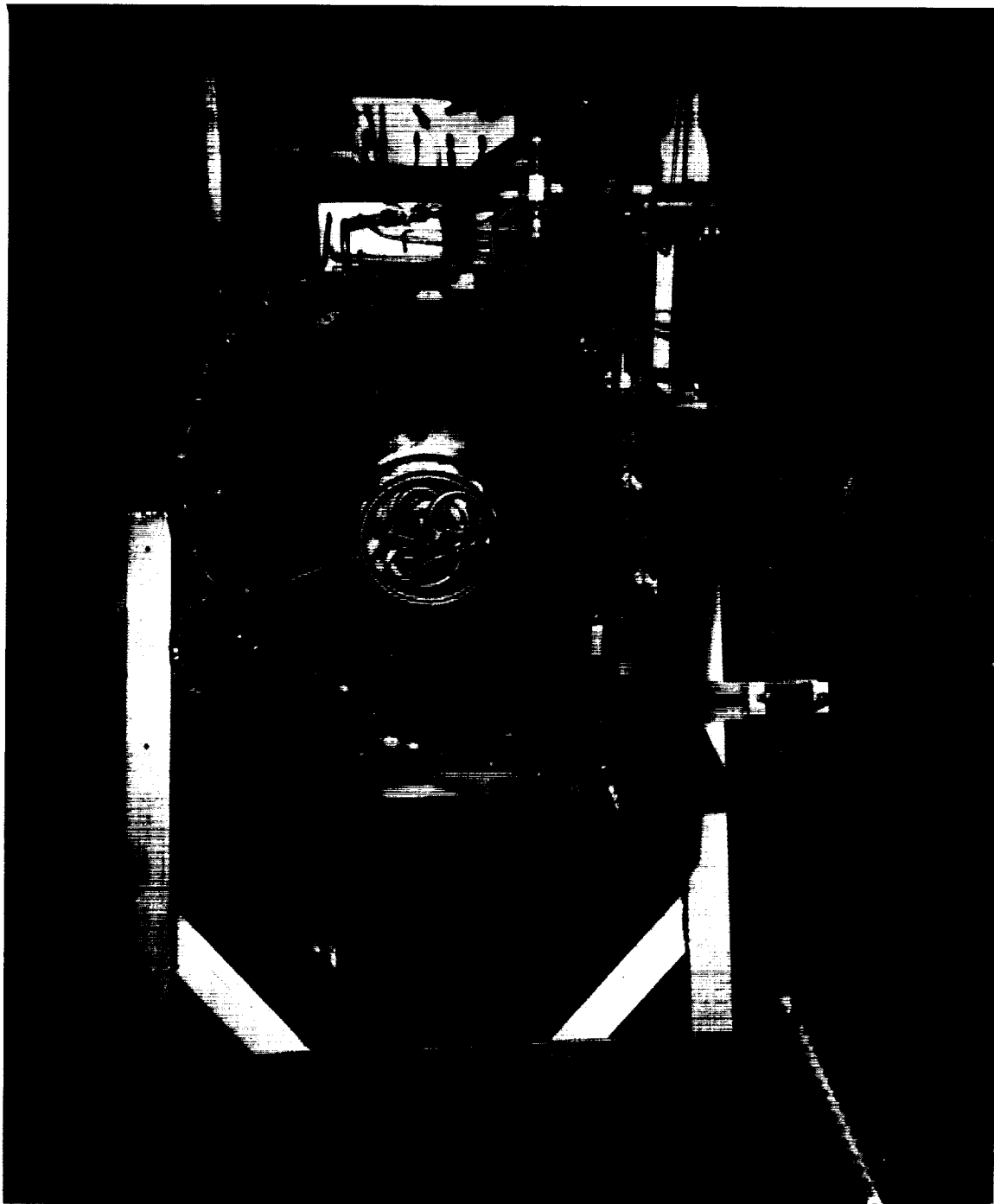

Figure F3.7-1.- Posttest oxygen tank setup.

F-51

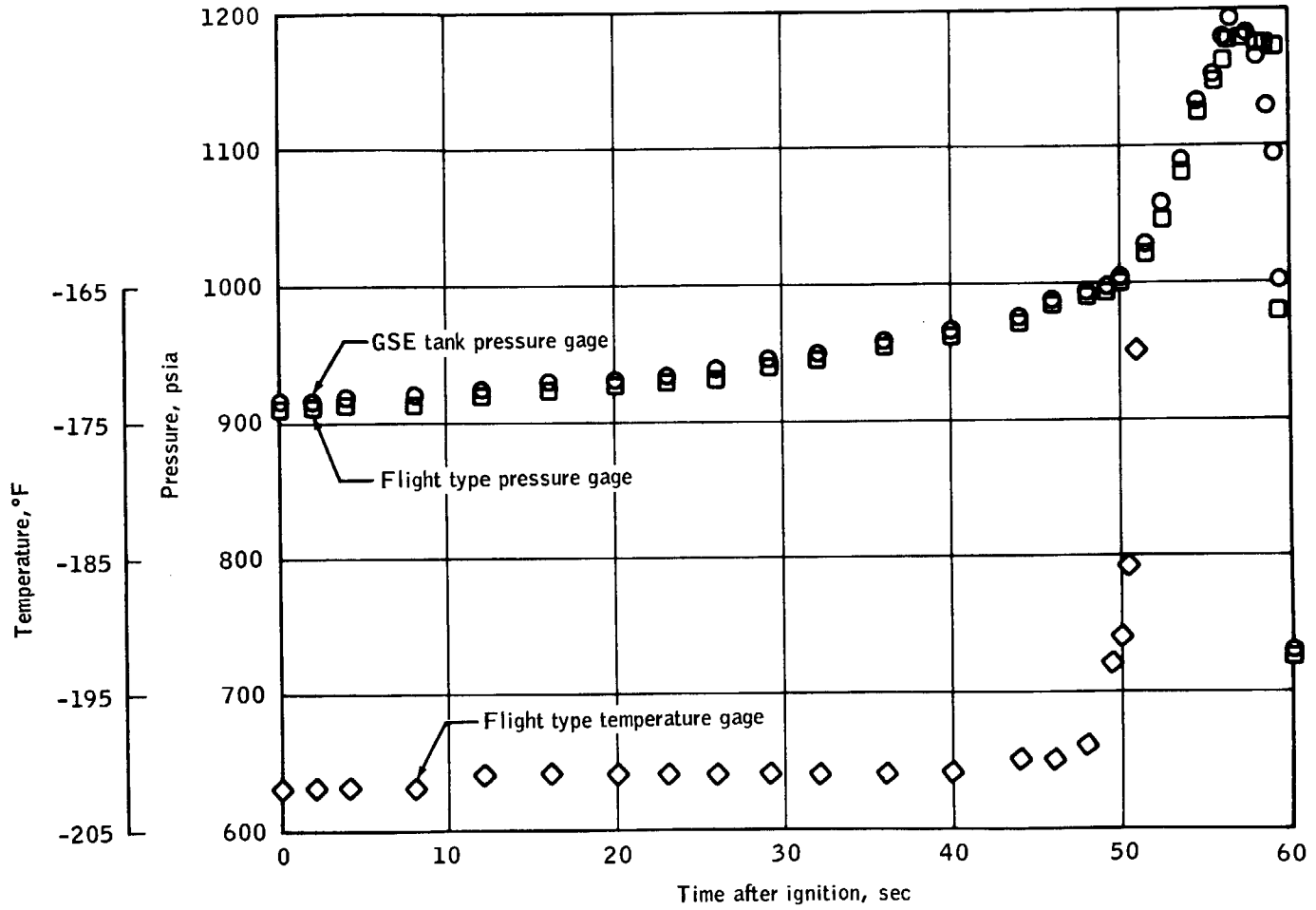

Figure F3.7-2.- Measured pressure and temperature time histories (preliminary data as of June 4, 1970).

F-52



(a) Wide-angle view.
Figure F3.7-3.- View of failed conduit.



(b) Closeup view.
Figure F3.7-3.- Concluded.

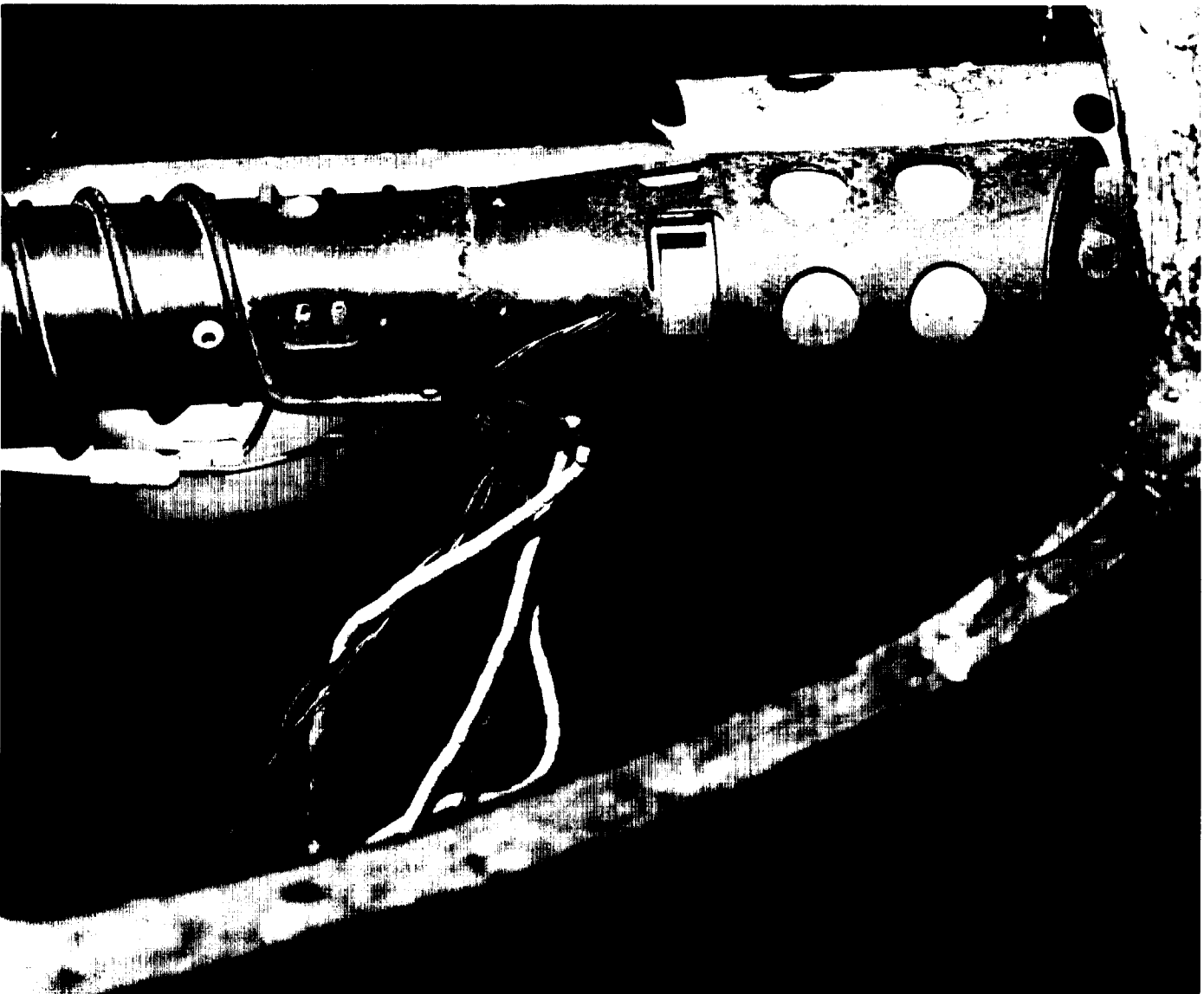

Figure F3.7-4. - Posttest internal view of tank components.

PART F3.8

ANALYSIS OF FLOW FROM RUPTURED OXYGEN TANK

Objective

The objective of this analysis was to compute the real gas discharge rate from the cryogenic oxygen tank no. 2 and provide the subsequent pressure history of various service module volumes.

Assumptions

1. Oxygen remains in equilibrium at all times. The oxygen properties were obtained from the tabulations and plots of references 2 and 3.
2. All orifice coefficients were taken to be unity and the orifices assumed to be choked.
3. All volumes and areas are invariant with time.
4. The effective volume of the oxygen tank is 4.7 ft^3 and is not changed by combustion processes.
5. All processes are isentropic both inside the oxygen tank and also between the oxygen tank and its discharge orifice.
6. Oxygen thermodynamic properties (ρ , p , h) are uniform throughout any given individual volume at any time.
7. The processes in volumes external to the oxygen tank are adiabatic. The total enthalpy in these volumes is equal to the average enthalpy of all prior discharged oxygen. Each volume acts as a plenum chamber for its respective vent orifice.
8. The initial tank conditions at $t = 0$ are $p = 900 \text{ psi}$; $\rho = 47.4 \text{ lb/ft}^3$; $T = -190^\circ \text{ F}$.

Method

Computations were based on several manually generated cross plots of the thermodynamic properties, correlations of intermediate computed results; and analytical and numerical integrations involving these

correlations. Choked orifice states were obtained by maximizing ρu for a given entropy.

Results

Figure F3.8-1 shows the mass flow rate per unit of effective orifice area plotted as a function of time. The two time scales shown are applicable to effective orifice diameters of 0.5 inch and 2.0 inches.

Figure F3.8-2 plots the total mass discharged from the oxygen tank against the same two time scales.

Figures F3.8-3 and F3.8-4 are plots of pressure time histories for various combinations of secondary volumes and orifices. The time scale in this case is only applicable to the 2-inch diameter exit orifice in the oxygen tank. The combinations of V and A^* shown in figure F3.8-3 were chosen to roughly simulate the components of the SM as follows:

1. $V = 25 \text{ ft}^3$, $A^* = 2.08 \text{ ft}^2$ (300 in^2). Simulates net volume of the oxygen shelf in bay 4 with effective venting of 300 in^2 .
2. $V = 67 \text{ ft}^3$, $A^* = 2.08 \text{ ft}^2$ (300 in^2). Simulates the bay 4 oxygen shelf and fuel cell shelf combined volume with venting of 300 in^2 .
3. $V = 67 \text{ ft}^3$, $A^* = 1.39 \text{ ft}^2$ (200 in^2). Same as case 2 but reduced venting area to rest of service module.
4. $V = 100 \text{ ft}^3$, $A^* = .43 \text{ ft}^2$ ($62\text{-}1/2 \text{ in}^2$). Simulates entire bay 4 with small venting.
5. $V = 200 \text{ ft}^3$, $A^* = .43 \text{ ft}^2$ ($62\text{-}1/2 \text{ in}^2$). Simulates combined bay 4 and tunnel volumes with venting past rocket nozzle only.

Also plotted are reference curves for each of the above volumes without any venting ($A^* = 0$).

Case 1 has a very rapid initial pressure rise with time due to the small volume (25 ft^3) of the oxygen shelf. However, the mass efflux from this volume also increases rapidly with time so that it equals the influx at $t = 0.18$ second and the pressure peaks at approximately 8.8 psia.

*If the tank were initially at $p \approx 1000$ psi and the same entropy, then with a 2-inch diameter orifice the pressure would drop to 900 psi in 0.004 second with the discharge of 1 lb_m oxygen.

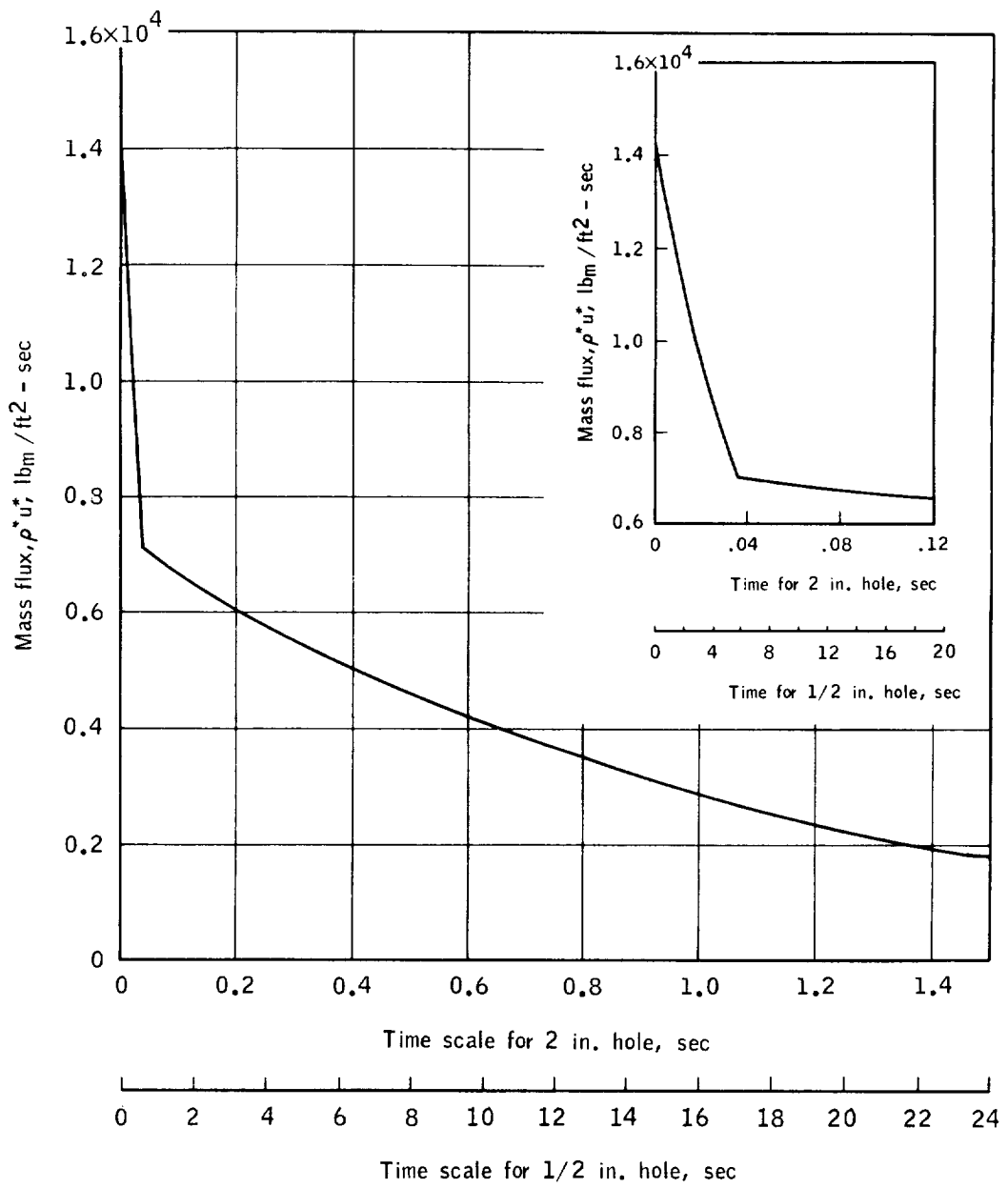

Figure F3.8-1.- Mass flow per unit area against time for 2 inch and 0.5 inch orifices.

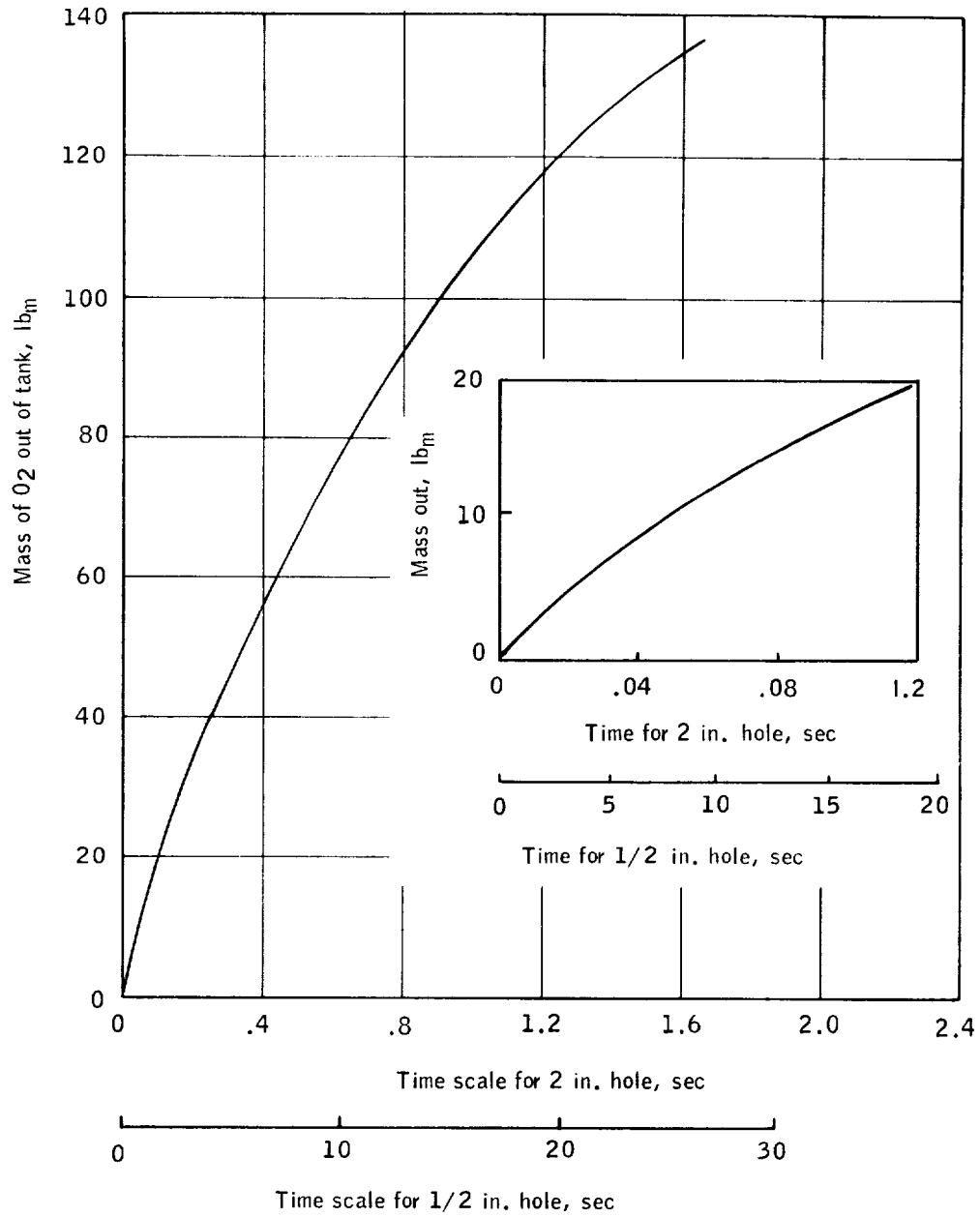

Figure F3.8-2.- Mass of oxygen expelled from tank against time.

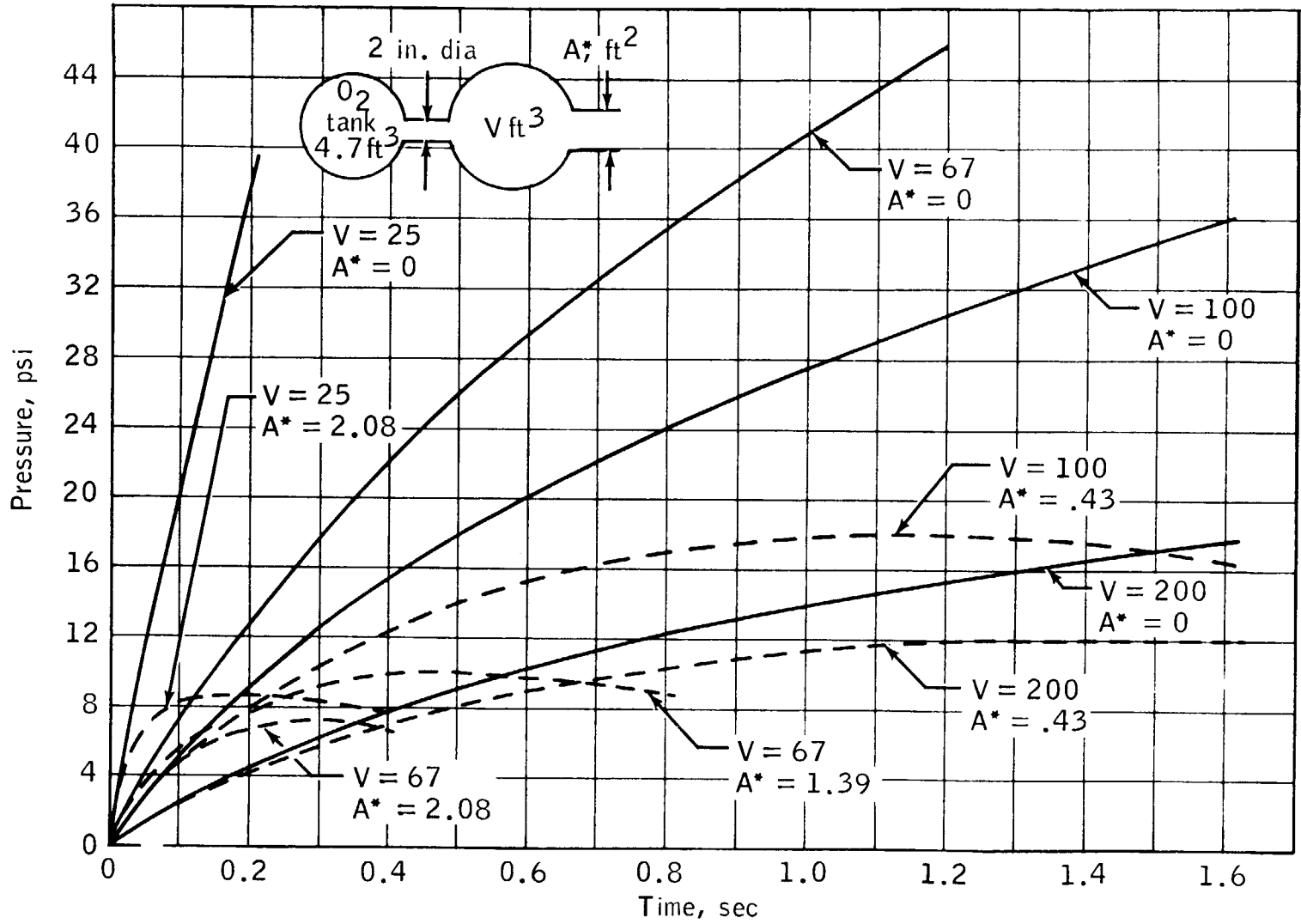

Figure F3.8-3.- Pressure rise against time.

F-60

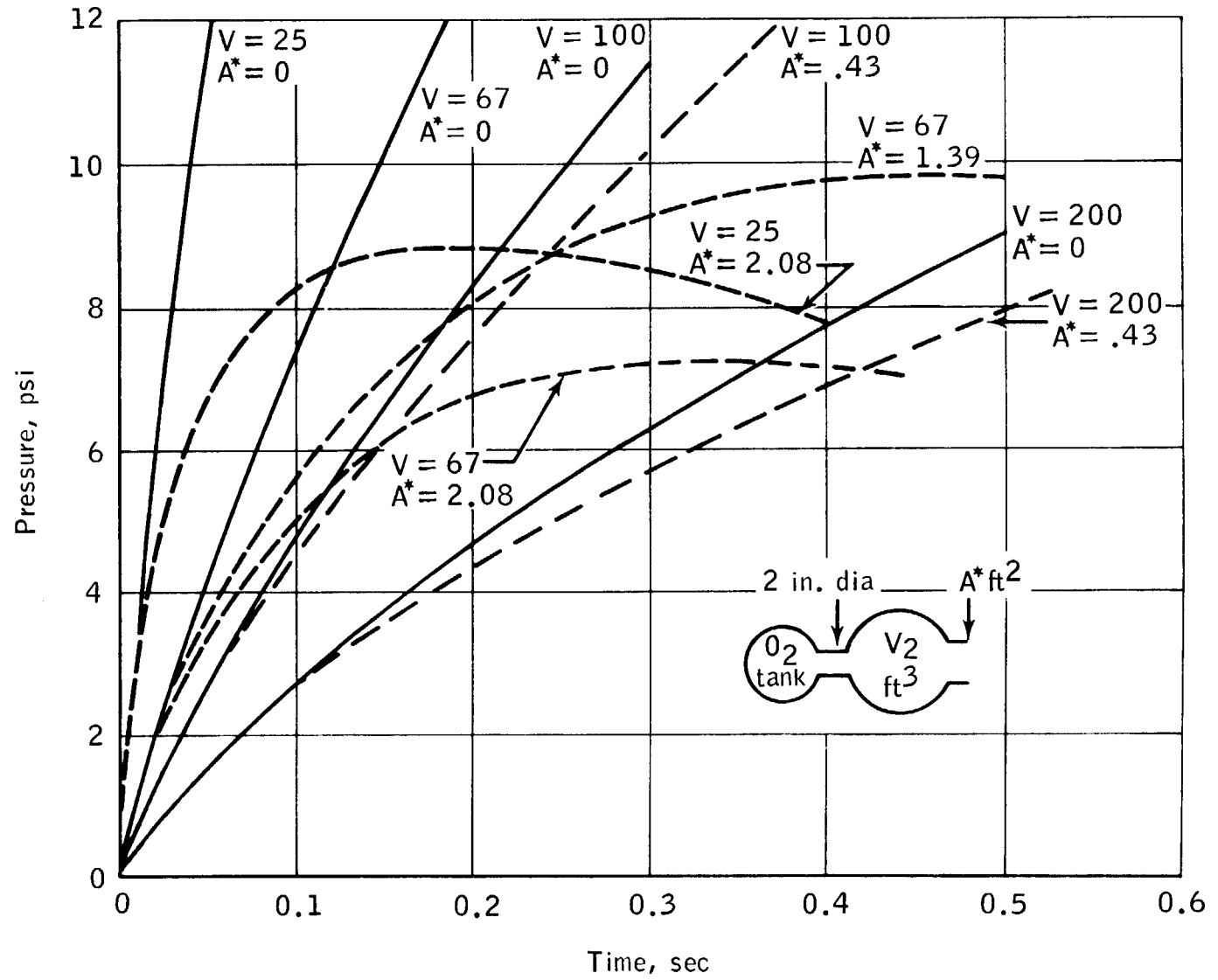

Figure F3.8-4.- Pressure rise against time (expanded scale).

The pressure of case 2, with $V = 67 \text{ ft}^3$, rises less rapidly and consequently peaks at a later time ($t = 0.32 \text{ sec}$) and a lower peak pressure ($p \approx 7.2 \text{ psi}$).

When the vent area for $V = 67 \text{ ft}^3$ is decreased from 300 in^2 to 200 in^2 (case 3), the pressure rises more rapidly, peaks at a longer time ($t \approx 0.45 \text{ sec}$), and has a higher peak pressure ($p \approx 9.8 \text{ psia}$).

The large volume solutions with minimum vent areas (cases 4 and 5) have higher peak pressures ($p \approx 18$ and 12 psia) occurring at much larger times ($t = 1.1$ and 1.5 sec).

Discussion and Conclusions

These "quasi-steady" two-volume, two-orifice, adiabatic calculations do not predict pressures in excess of 20 psia for a 2-inch diameter effective orifice in the oxygen tank. In fact, if the two larger volume simulations (cases 4 and 5) are excluded due to unrealistically low venting areas and/or the long time rise, then the maximum predicted pressure is below 10 psia . The smaller volumes representative of the oxygen shelf, or the oxygen shelf plus fuel cell shelf (which is fairly well inter-vented to the oxygen shelf) have shorter rise times which are more representative of the implied "time to panel failure" of Apollo 13. The effective venting area of these volumes is also more realistic.

On the basis of these approximate calculations, the following alternative possibilities might be considered:

1. The panel failure pressure is below 10 psi . Other experiments show this low failure pressure level to be unlikely.

2. The dynamic unsteady pressures exceed the computed quasi-steady pressures. A non-uniform pressure distribution with internal moving pressure waves is considered very probable with their importance being larger for the smaller times and volumes.

3. The oxygen tank orifice had an effective diameter greater than 2 inches. During the discharge of the first 9 pounds of oxygen, the orifice was choked with nearly saturated liquid oxygen and the coefficient was probably nearer 0.6 than 1 . Thus an effective 2-inch diameter would require an even larger physical hole during this time.

4. The processes in the oxygen tank were not isentropic in a fixed volume. Either continued combustion inside the oxygen tank or the presence of a bubble of combustion products at the time of initial gas release could prevent the computed rapid decrease in mass flow with time (fig. F3.8-1) and thereby increase the pressure rise rate and the peak pressure.

5. The processes in the external volume (V) are not adiabatic. Combustion of the Mylar insulation has been estimated to produce large pressures (several atmospheres) if the combustion process is rapid enough.

6. The oxygen processes are not in equilibrium. The possibility of super-saturation of the oxygen discharged into the bay and subsequent flashing to vapor might produce a strong pressure pulse.

PART F3.9

MYLAR-INSULATION COMBUSTION TEST

Objective

The purpose of this test was to determine the ignition properties and measure the rate of combustion of Mylar insulation in an initially evacuated simulated oxygen shelf space. The conditions of this test are achieved by ejection of oxygen from a 1000 psia/-190° F oxygen supply with ignition by pyrofuses placed on the Mylar blanket at several locations.

Apparatus

The basic dimensions and arrangement of the apparatus are shown in figure F3.9-1. An end view of the apparatus is shown in figure F3.9-2. Mylar blank material is placed on the bottom shelf. Oxygen is supplied through a regulator into a simulated tank dome volume. The dome contains a 2-inch diameter rupture disc which is designed to open at 80 psi. Pressures are measured during the course of combustion process. High-speed motion pictures are obtained through window ports in the chamber. The chamber volume and vent area simulate the oxygen tank shelf space.

Approach

Oxygen is supplied from a cryogenic source which is initially at 1000 psia/-190° F. Oxygen flows for a controlled time into the dome volume. The 2-inch disc ruptures at 80 psi. This exposes the initially evacuated chamber and its contents to a mixture of liquid and gaseous oxygen. A series of pyrofuses are then ignited in sequence. The data include high-speed motion pictures and pressure-time histories.

Results

A test in which oxygen was allowed to flow for 3 seconds from an initially 1000 psia/-190° F source resulted in complete combustion of a 14.5 ft² Mylar blanket sample. Five pyrofuses located at various locations on the Mylar blanket were sequentially activated at times ranging between 0.3 and 1.4 seconds after the disc ruptured. Examination of the chamber after this run showed that all of the Mylar blanket was consumed. The pressure rise rate with the addition of oxygen but before ignition was approximately 6 psi/sec. Ignition occurs when the pressure rises to

about 10 psi with subsequent combustion which causes a sharp increase in the pressure rise rate. The rate of pressure rise during the combustion process reaches approximately 42 psi/sec. The initial pressure rise rate of 6 psi/sec also corresponds to a measured rise rate obtained in an earlier test in which combustion did not occur. The pressure data are shown in figure F3.9-3. The conditions in the chamber before the test are shown in figure F3.9-4. Figure F3.9-5 shows the chamber just after the test.

Conclusion

The Mylar insulation blanket burns completely when ignited locally and exposed simultaneously to oxygen from a 1000 psi/-190° F source. The pressure rise rate increases from 6 psi/sec without combustion to about 42 psi/sec with the combustion of Mylar. A substantial increase in the pressure rise rate in the oxygen tank shelf space due to Mylar combustion might therefore be expected. From tests conducted elsewhere, it is further concluded that an ignition source is required to achieve Mylar/oxygen combustion.

F-65

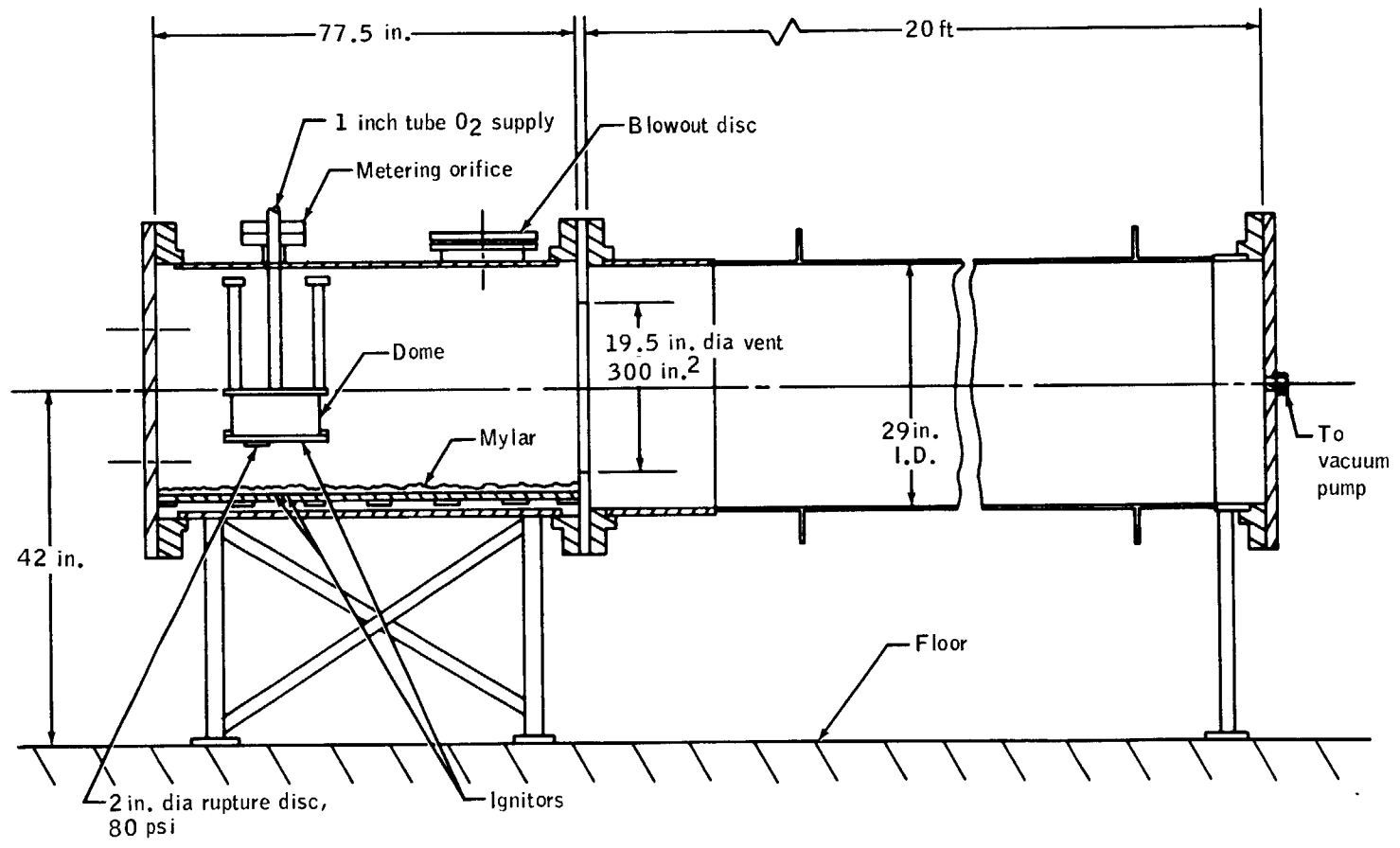

Figure F3.9-1.- Assembly of test fixture.

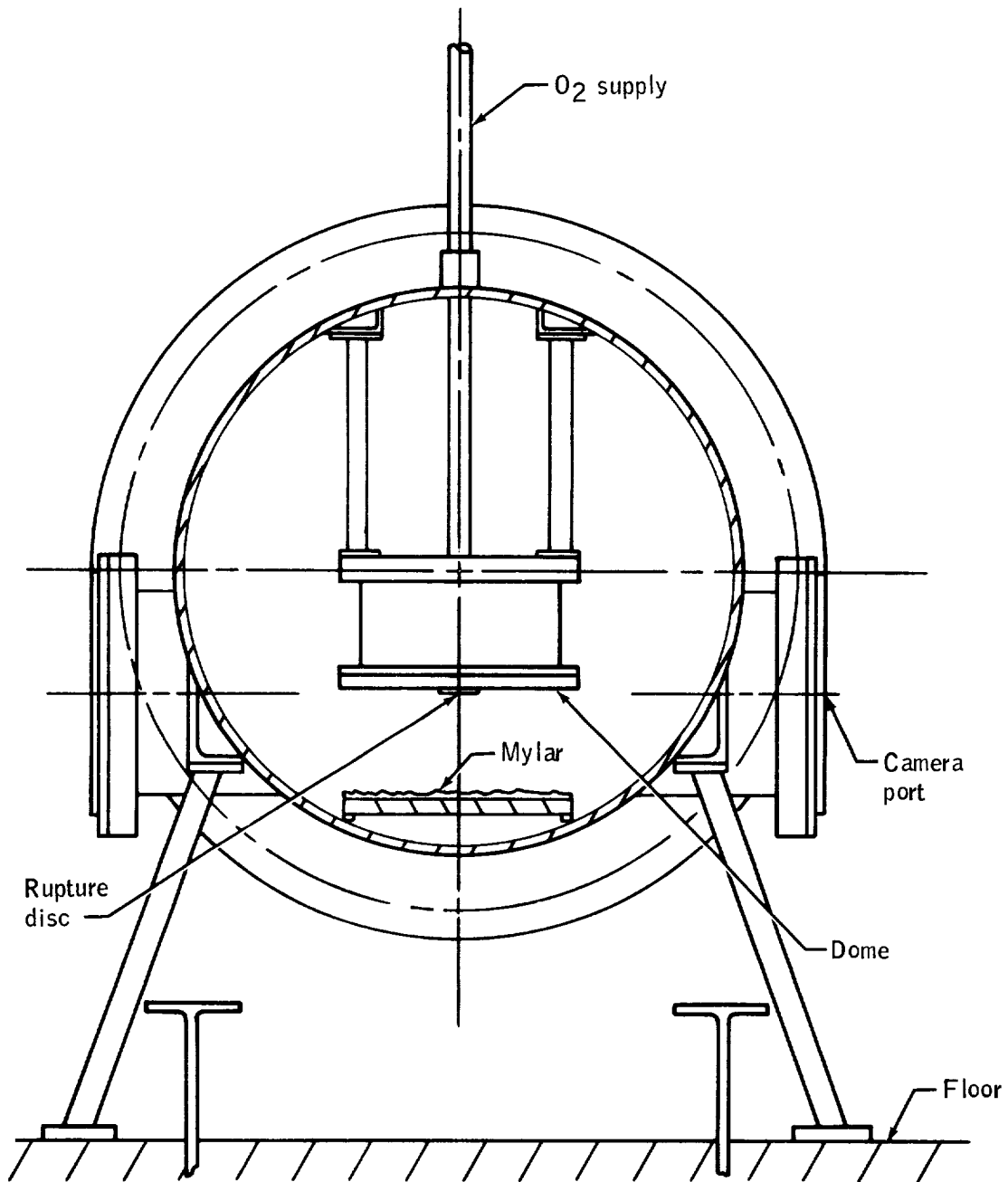

Figure F3.9-2.- Section through test fixture.

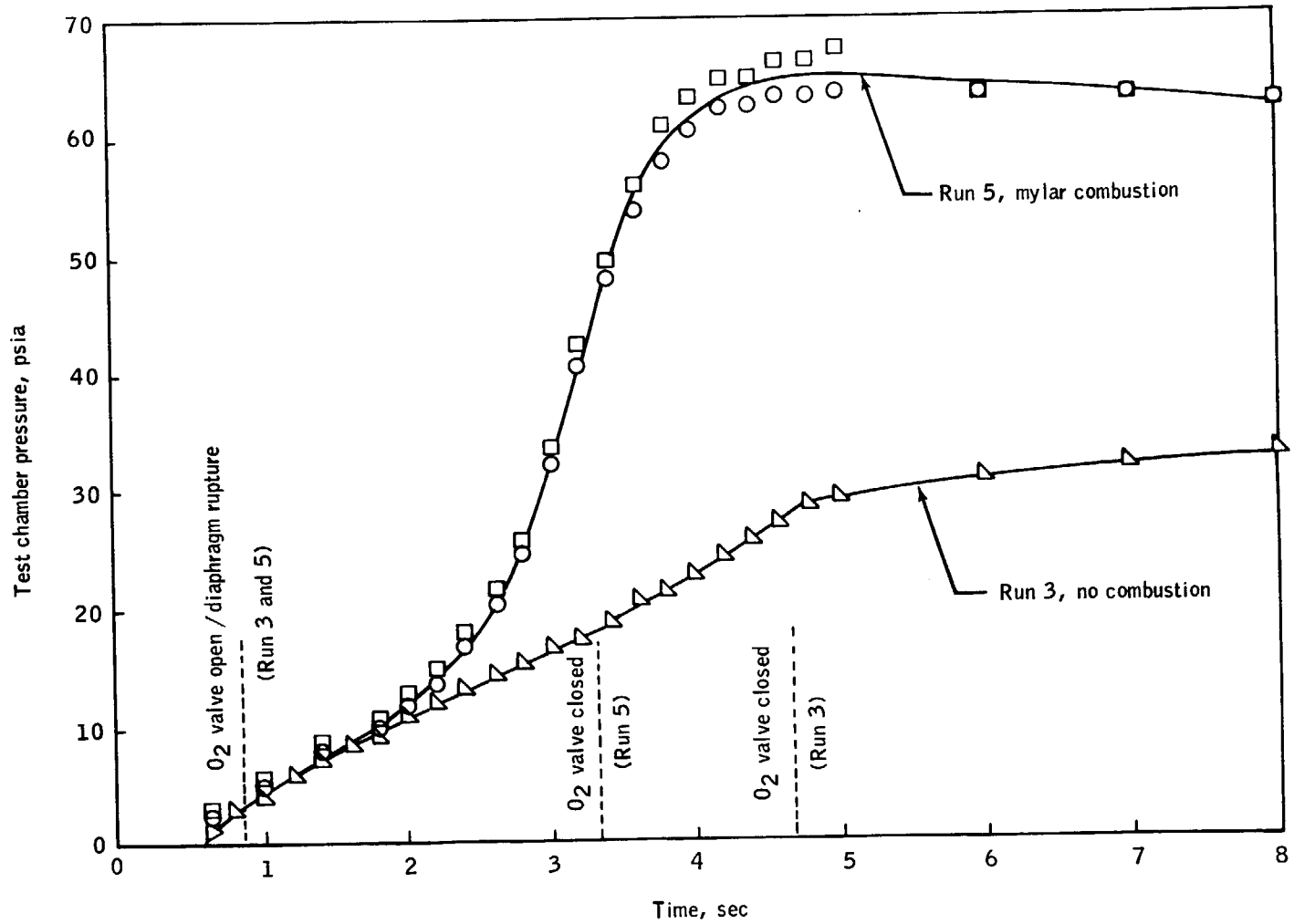

Figure F3.9-3.- Measured pressure histories for runs with and without Mylar combustion (initial oxygen tank temperature for Run 3 was -186° F and for Run 5 was -192° F).

F-68

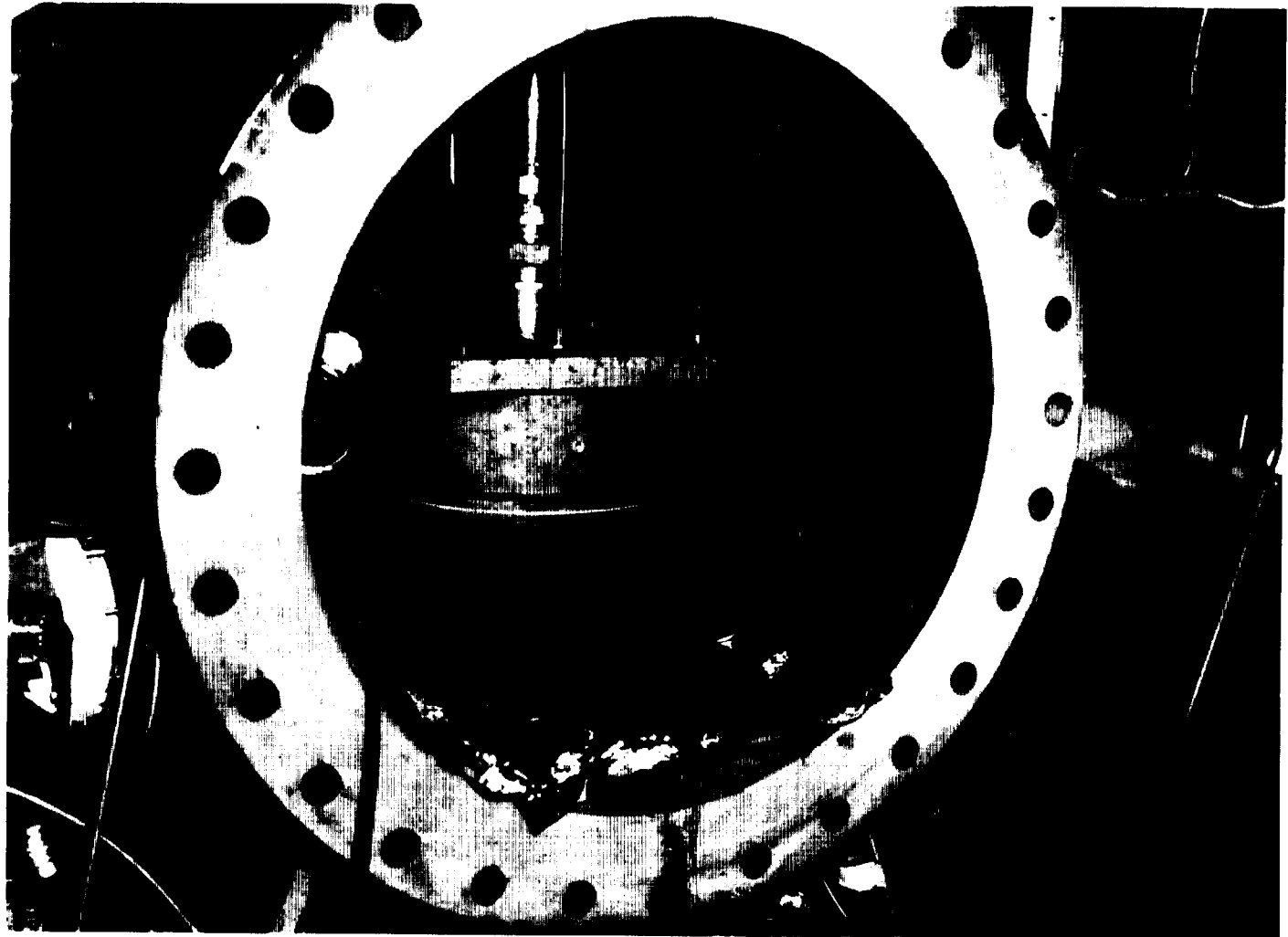

Figure F3.9-4.- View of chamber conditions before test.

F-69

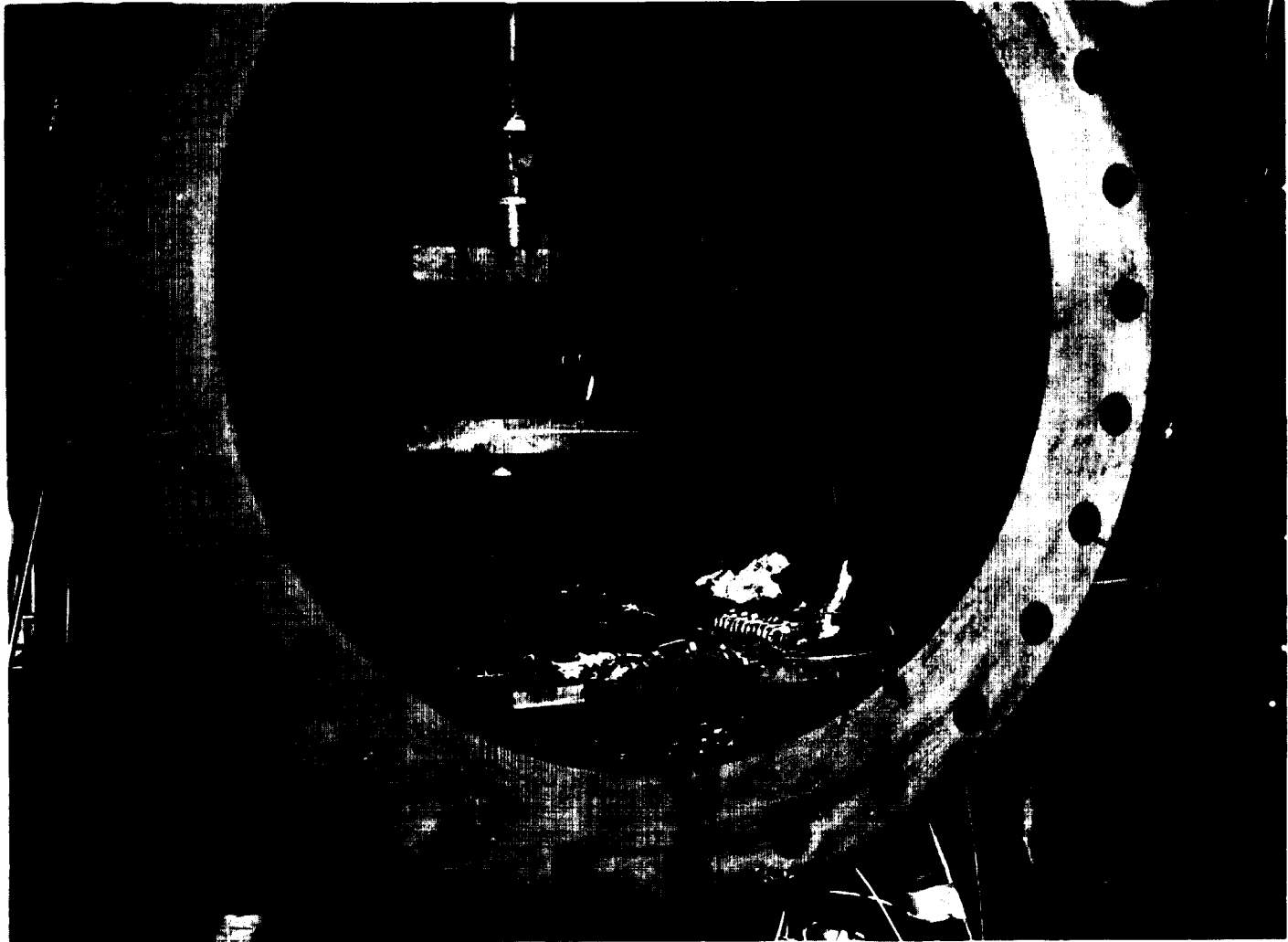

Figure F3.9-5.- View of chamber conditions after test.

PART F3.10

PANEL SEPARATION TESTS

Objectives

The objective of these tests was to demonstrate complete separation of the SM bay 4 cover panel in a manner that could be correlated with flight conditions. The panel failure mechanism and the pressure distribution that resulted in separation were also to be determined.

Approach

An experimental and analytical program utilizing one-half scale dynamic models of the SM bay 4 cover panel was conducted. Panels were attached through replica-scaled joints to a test fixture that simulated pertinent SM geometry and volume. Venting was provided between compartments and to space. A high-pressure gas system was used to rapidly build up pressure behind the cover panel as the input force leading to failure.

Size of the dynamic models (one-half scale) was determined primarily by material availability. The use of full-scale materials and fabrication techniques in the model was dictated by the need to duplicate a failure mechanism. Therefore, similarity laws for the response of structures led to scale factors of one-half for model time and one-eighth (one-half cubed) for model mass. From these scale factors for the fundamental units, some of the derived model to full-scale ratios are as follows:

Displacement	= 1/2	Force	= 1/4
Velocity	= 1	Pressure	= 1
Acceleration	= 2	Stress	= 1
Area	= 1/4	Energy	= 1/8
Volume	= 1/8	Momentum	= 1/8

A step-by-step approach to testing led to rapid learning as new factors were introduced. Initial tests were conducted on isotropic panels that scaled only membrane properties while more completely scaled sandwich panels were being fabricated. Testing started in atmosphere while preparations for vacuum testing were underway. In a similar manner, first tests concentrated on determining the pressure input required for separation and deferred the simulation of internal flow required to produce these distributions to later tests.

Analysis of the one-half scale bay 4 cover panel models used two computer programs. Initial dynamic response calculations using a nonlinear elastic finite difference program indicated that panel response was

essentially static for the class of pressure loadings expected in the tests. Subsequent calculations used static loadings with a nonlinear elastic finite element representation and the NASTRAN computer program.

Apparatus

Models.- Figure F3.10-1 shows the full-scale and model panel cross sections.

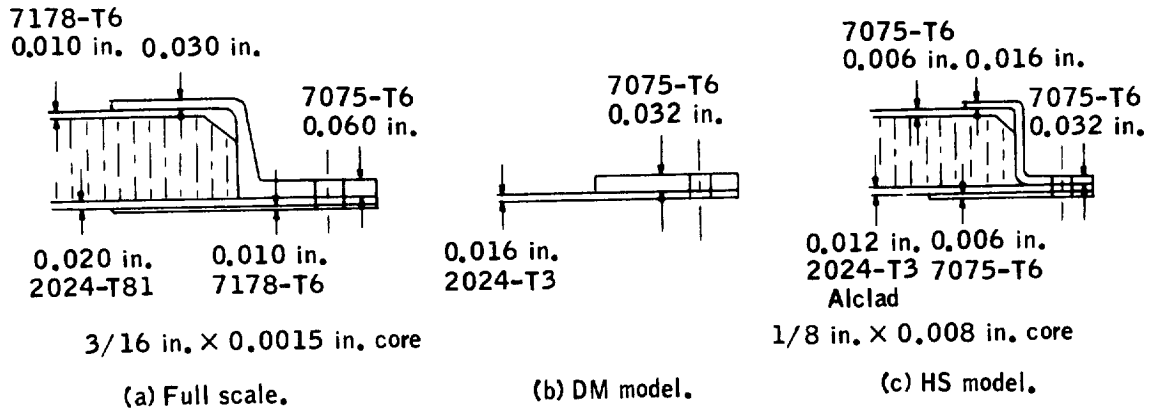

Figure F3.10-1.- Panel designs.

The full-scale panel is a honeycomb sandwich structure with a z-bar edge closeout attached to the SM by 1/4-inch bolts around the edges and to each of the bay 4 shelves. The first one-half scale panel models, designated DM and shown in figure F3.10-1(b), scaled membrane properties of the full-scale sandwich panel inner and outer face sheets with a single isotropic panel having the correct nominal ultimate tensile strength. The z-bar was simulated by a flat bar that represented the shear area of the outer z-bar flange. Fastener sizes, bolt patterns, and bonding material were duplicated from full scale.

One-half size honeycomb sandwich panels, designated HS and shown in figure F3.10-1(c), scaled both bending stiffness and membrane stiffness. Although core density of the sandwich models is slightly high, the dimensions, materials, bonding, and z-bar closeout are scaled. Some alloy substitutions were made but nominal strength requirements were met.

Test fixture.- The test fixture shown schematically in figure F3.10-2 and in the photographs of figure F3.10-3 is a one-half size boilerplate mockup of the SM bay 4 and central tunnel. Vent areas connect the bay 4 shelf spaces to the central tunnel and to each other. The tunnel also has

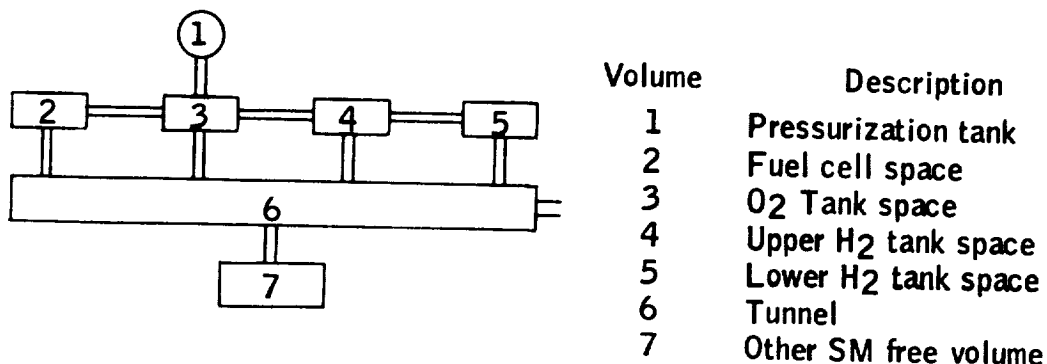
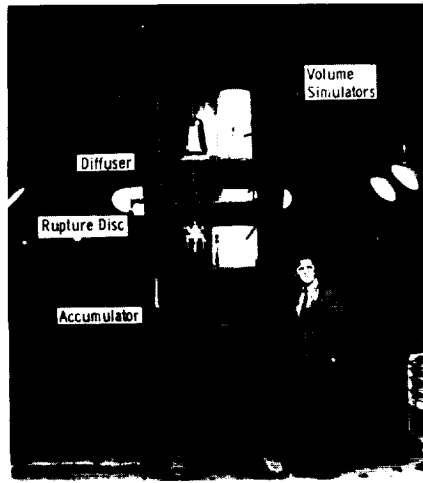

Figure F3.10-2.- Schematic of test fixture.

vents to space and to a large tank simulating the remaining free volume of the SM. Vent areas were adjusted in initial tests to obtain desired pressure distributions but were scaled from the best available data for final testing. The fixture also holds the pressurization system and instrumentation. True free volume was approached by adding several wooden mockups of equipment.

Pressurization system.- The pressurization system can also be seen in the photographs of figure F3.10-3. A 3000-psi accumulator is discharged on command through an orifice by mechanically rupturing a diaphragm. The gas expands into the oxygen shelf space of bay 4 through a perforated diffuser. In order to obtain uniform pressure over the entire panel for some tests, the diffuser was lowered so that it discharged into both the oxygen and hydrogen shelf spaces. For these particular tests, extra vent area was provided between all shelves to insure uniform pressure throughout bay 4. For most tests, a shield was placed between the diffuser and panel to minimize direct impingement.

Other.- Instrumentation consisted of strain gages, fast response pressure sensors, and high-speed motion picture cameras. Atmospheric tests were conducted in the Rocket Test Cell and vacuum tests at 1mm Hg pressure in the 60-Foot Vacuum Sphere at Langley Research Center.



(a) General view.

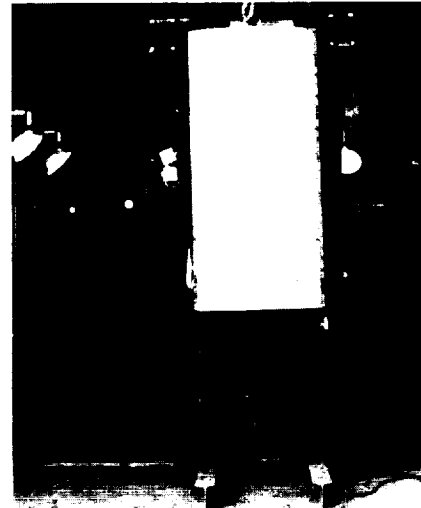

(b) Fixture with panel installed.

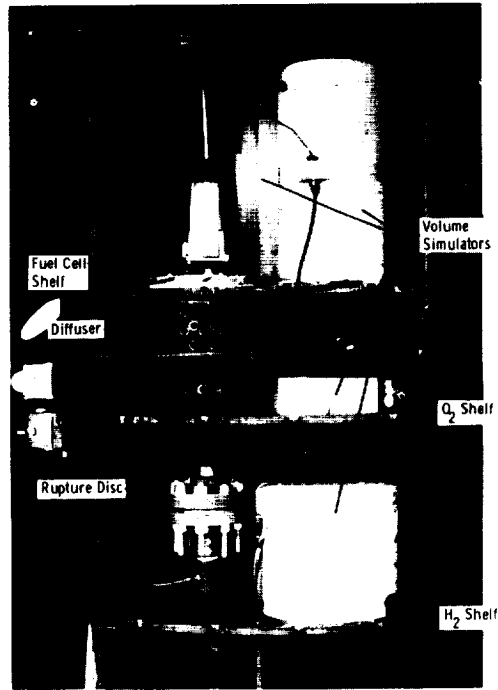

(c) Internal view.

Figure F3.10-3.- One-half size boilerplate mockup of the SM bay 4 and central tunnel.

Results and Discussion

Presentation of results.- The test program is summarized in table F3.10-I. Typical failures and pressure-time histories are illustrated in figure F3.10-4. Figure F3.10-5 is a sequence of prints from high-speed movie cameras that demonstrate separation of the sandwich panel models. Results of NASTRAN calculations on the one-half scale models are presented in figures F3.10-6 and F3.10-7.

Demonstration of panel separation.- Panel separation has been demonstrated with both membrane and sandwich panels. Two sandwich panels separated completely from the test fixture during vacuum tests. Two membrane panels, although less representative of flight conditions, also separated completely in vacuum tests. However, similar tests with membrane panels in atmosphere left portions of panels attached to the test fixture as illustrated in figures F3.10-4(b) and (c). Complete separation in atmosphere could not be achieved due to mass and drag of the air.

Pressure distributions.- Complete membrane panel separation was achieved only with nearly uniform pressure distribution over the entire bay 4 panel cover, shown in figure F3.10-4(d). When just the oxygen shelf space experienced high pressures, membrane panel separation was localized to the area of the panel over the oxygen shelf space as shown in figure F3.10-2(a). This type of local failure occurred in both atmosphere and vacuum. When scaled internal venting was introduced, model DM-10 lost a slightly larger portion of panel due to high pressure experienced by both the oxygen shelf and fuel cell shelf spaces while the rest of bay 4 was at low pressure.

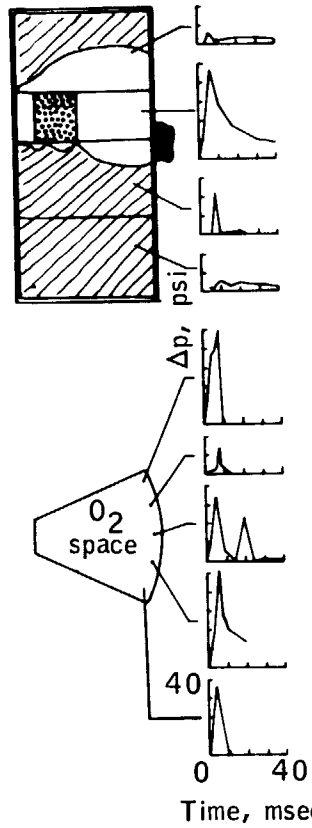

a. Membrane panel DM-2, atmosphere, band load

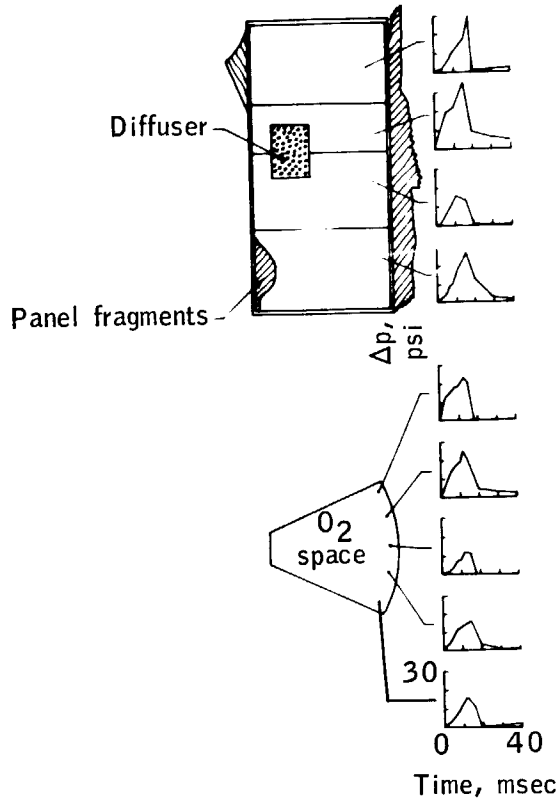

b. Membrane panel DM-3, atmosphere, uniform load

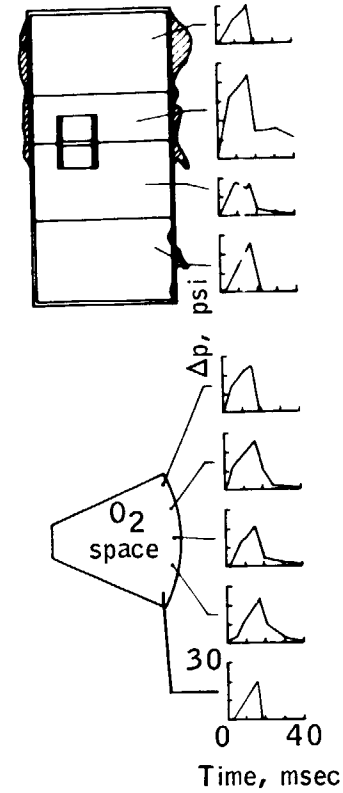

c. Membrane panel DM-4, atmosphere, uniform load, no direct impingement

Figure F3.10-4.- Failure modes and pressure-time histories.

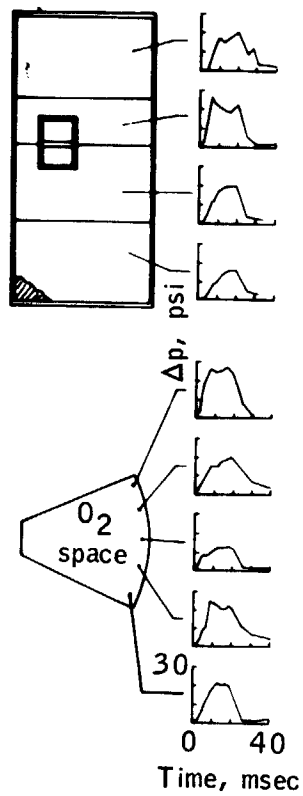

d. Membrane panel DM-6, vacuum, uniform load, no direct impingement

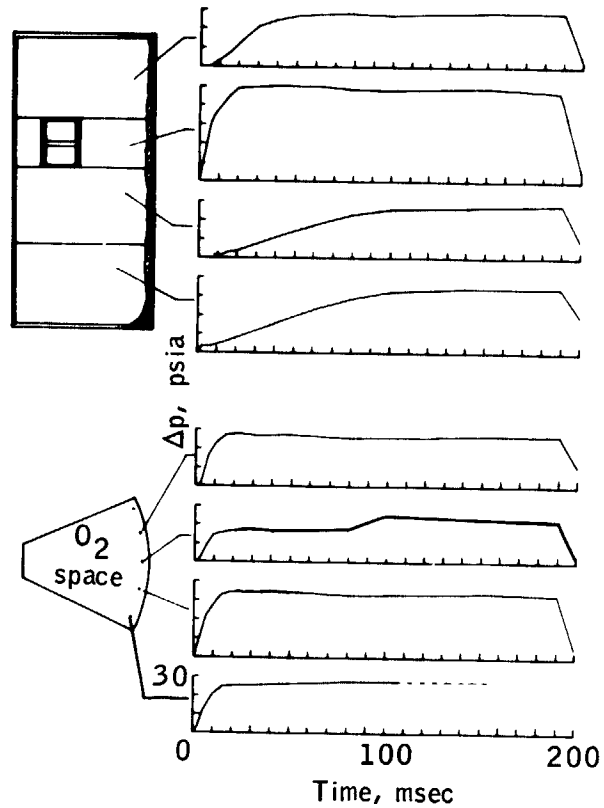

e. Sandwich panel HS-2, vacuum, no direct impingement

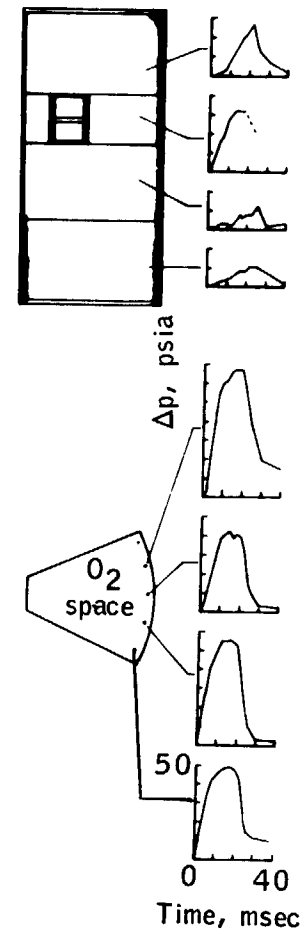

f. Sandwich panel HS-3, vacuum, no direct impingement

Figure F3.10-4.- Concluded.

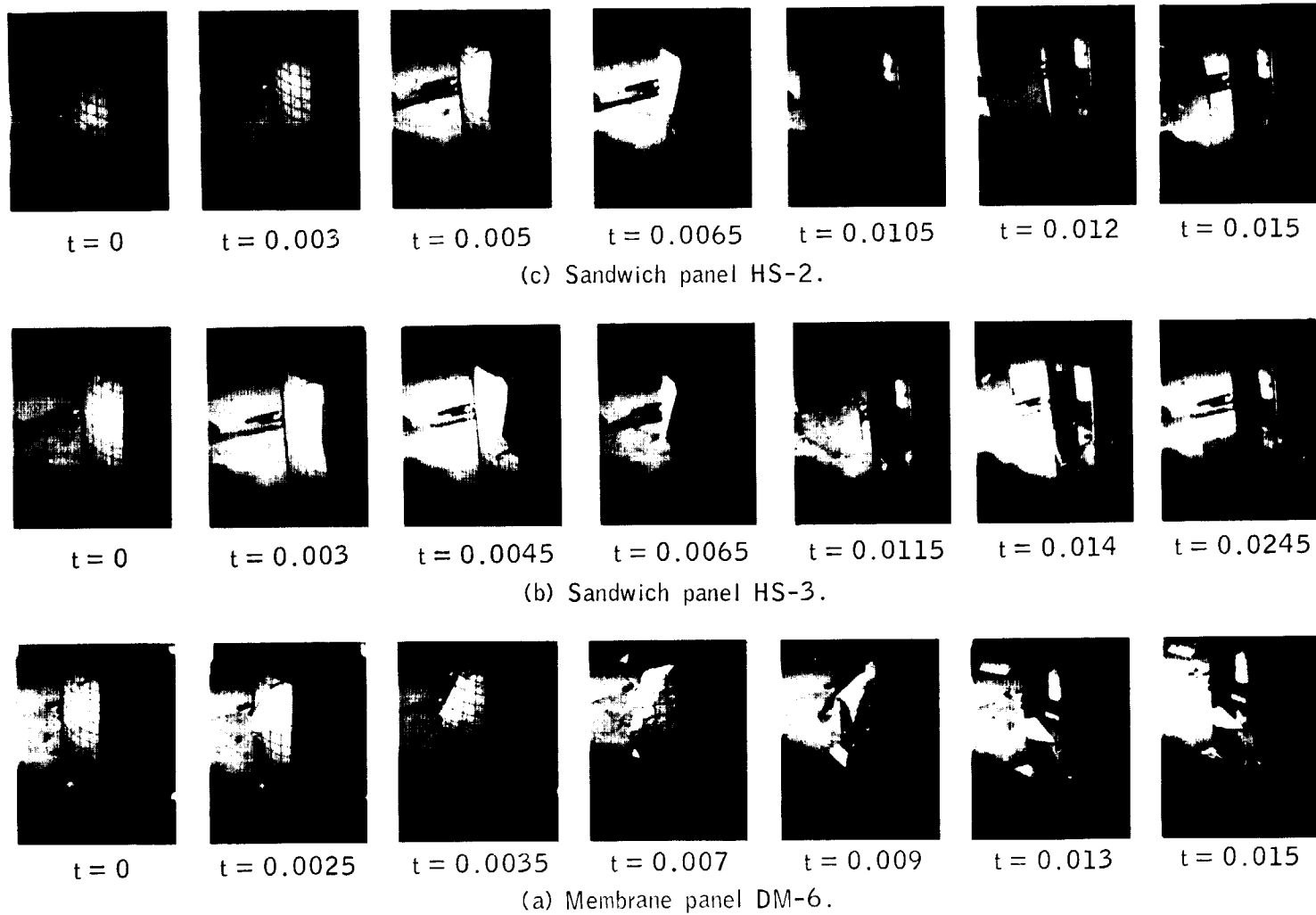

Figure F3.10-5.- Sequential failure of two sandwich and one membrane panel (t = time from first observed failure).

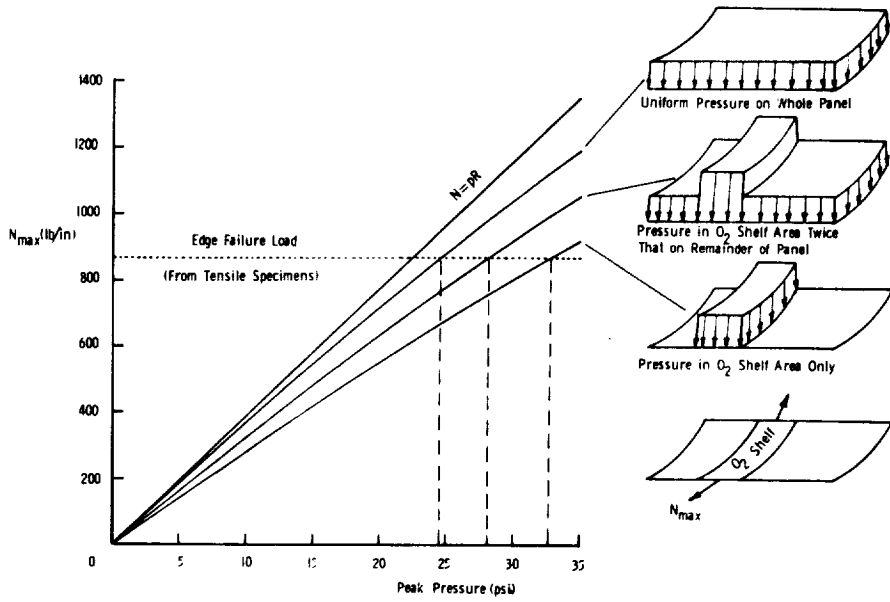

Figure F3.10-6.- Maximum edge load on half-scale honeycomb panel as predicted by NASTRAN.

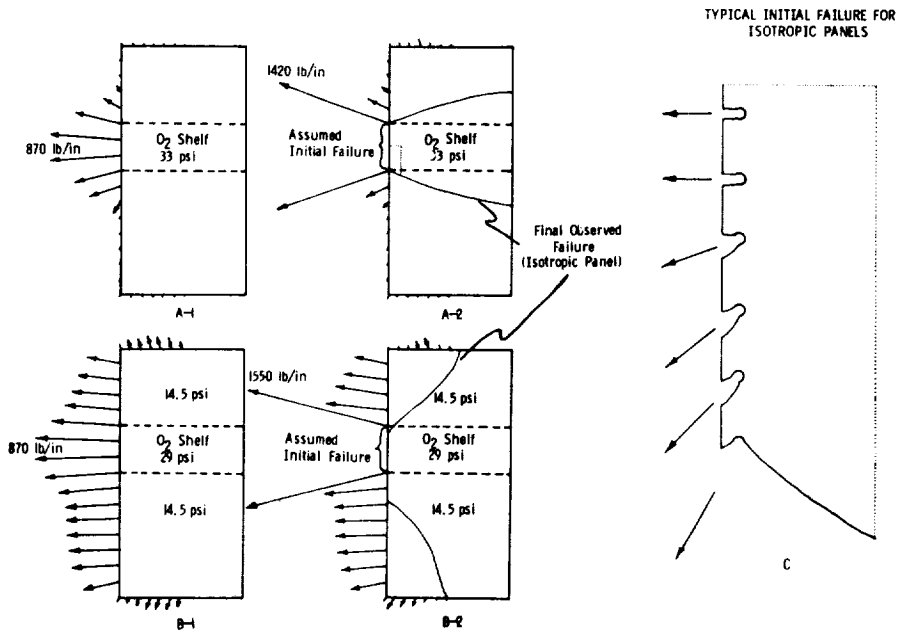

Figure F3.10-7.- Distribution of edge loads on half-scale Apollo 13 honeycomb panel as predicted by NASTRAN.

TABLE F3.10-I.- PANEL SEPARATION TEST SUMMARY

Model	Internal vents	Volume first pressurized	Diffuser	Load character	Pressure*		Failure
					Peak, psi	Rise time, sec	
Atmosphere tests							
DM-1-1	Not scaled	Oxygen shelf	Open	Band	24-30	0.020	None
DM-1-2	Not scaled	Oxygen shelf	Open	Band	30-58	0.005	Oxygen shelf area
DM-2	Not scaled	Oxygen shelf	Open	Band	34-52	0.006	Oxygen shelf area
DM-3	Not scaled	Bay 4	Open	Uniform	15-35	0.015	Nearly total (folded back)
DM-4	Not scaled	Bay 4	Shielded	Uniform	20-26	0.016	Nearly total (left edges)
Vacuum tests							
DM-5-1	Not scaled	Bay 4	Shielded	Uniform	14-20	-	None
DM-5-2	Not scaled	Bay 4	Shielded	Uniform	20-28	0.016	Total
DM-6	Not scaled	Bay 4	Shielded	Uniform	19-27	0.018	Total
DM-7	Not scaled	Oxygen shelf	Open	Band	25-40	0.005	Oxygen shelf area
DM-8	Not scaled	Oxygen shelf	Shielded	Band	20-37	0.012	Oxygen shelf area
DM-9	Not scaled	Oxygen shelf	Shielded	Band	18-23	0.040	None
DM-10	Scaled	Oxygen shelf	Shielded	-	21-39	0.070	Upper 2/3 of panel
HS-1	Scaled	Oxygen shelf	Shielded	-	-	-	None
HS-2	Scaled	Oxygen shelf	Shielded	-	23-32	0.190	Total
HS-3	Scaled	Oxygen shelf	Shielded	-	30-67	0.020	Total
HS-4	Scaled	Oxygen shelf	Shielded	-	30-44	0.020	None

*Range of peak pressures in the oxygen shelf space is indicated. Time from pressure release to peak pressure is rise time.

Complete separation of sandwich panels has been obtained with both uniform and nonuniform pressure distributions. Figure F3.10-8 shows the type of pressure time histories experienced by various sections of the panels. The pressure predictions are based on the internal flow model

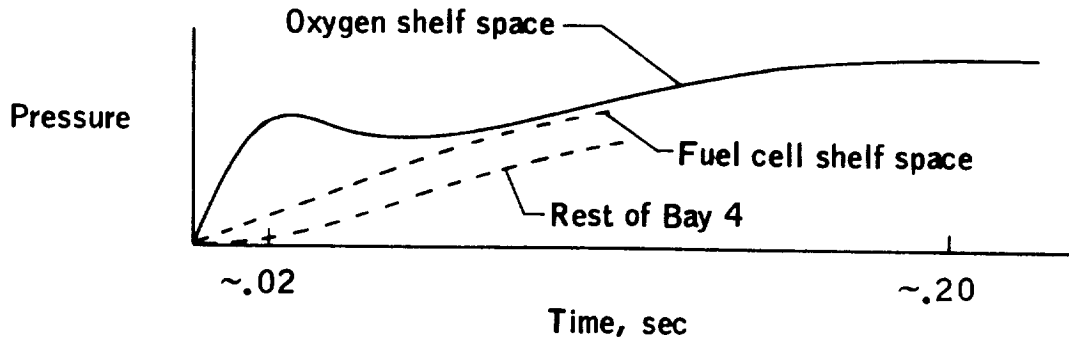

Figure F3.10-8.- Pressure build-up in bay 4.

of the Apollo 13 SM shown in figure F3.10-2 and have been verified in these experiments. Peak pressure levels were varied from test to test but the curve shape was always similar. One sandwich panel separated after about 0.02 second during the initial pressure rise in the oxygen shelf space, while overall panel loading was highly nonuniform as shown in figure F3.10-4(b). The other sandwich panel did not separate until about 0.19 second after all bay 4 compartments had time to fill with gas and arrive at a much more uniform loading, as shown in figure F3.10-4(e).

The effect of pressure distribution on peak pressures required for failure is shown by the NASTRAN calculation in figure F3.10-6. Included for reference is the linear membrane result, $N = pR$. The load required for edge failure was determined from tensile tests on specimens of the DM model joints. The peak uniform pressure at failure initiation is only 75 percent of peak pressure at the failure load with just the oxygen shelf space pressurized.

Failure mechanism.- The failure mechanism for complete separation of a membrane panel is demonstrated by the photographic sequence in figure F3.10-5(a). Failure is probably initiated by a localized high pressure near the edge of the oxygen shelf space. A crack formed where a shelf bolt head pulled through and rapidly propagated through the panel. Expansion of the pressurizing gas through the openings accelerated

panel fragments to very high velocities. Inertia loads from the high acceleration completed the separation. Membrane panels were observed to separate in three pieces--one large and two small fragments.

The failure of a sandwich panel under uniform loading in vacuum is shown in the picture sequence of figure F3.10-5(c). Failure started at the edge of the oxygen shelf space by pull-through of the edge bolts through the upper sandwich face sheet. Very rapid tearout along three edges followed, primarily by tension in the face sheets and tearing of the core material from the z-bar at the edge. The panel then rotated like a door and separated from the test fixture in one piece.

Nonuniform loading of a sandwich panel led to the failure shown in figure F3.10-5(b). Initial failure was at the panel edge near the fuel cell shelf. Tearout along one edge and the top rapidly followed, similar to the previous failure. However, the edge tear stopped before reaching the bottom and became a diagonal rip that left the lower third of the panel attached to the fixture. The upper two-thirds of the panel then rotated door-like and separated. Finally, a vertical tear propagated through the center of the remaining fragment, the bottom tore out, and rapid rotation separated the remnants in two pieces.

Figure F3.10-7 relates NASTRAN calculations to the observed failures. Predicted edge load direction and magnitude are illustrated for two pressure distributions. In figure F3.10-7, parts A-1 and B-1, panel edges are assumed fixed, while in figure F3.10-7, parts A-2 and B-2, the panel edge joint along the oxygen shelf space is assumed to have failed. Also shown in figure F3.10-7, parts A-2 and B-2, are typical observed failure patterns for these types of loadings on membrane panels. An enlargement of the dotted section of figure F3.10-7, part A-2, is shown in part C of the figure to indicate the type of edge failure observed. Arrows indicate the direction of force required to cause the pullout failures. The NASTRAN edge force patterns are consistent with these failures. In addition, figure F3.10-7, parts A-2 and B-2, indicates that tears into the membrane panels tend to remain normal to the direction of the edge forces.

Correlation with flight.- Tests with sandwich panels more closely simulate flight conditions than tests with membrane panels due to initial failure characteristics and post-failure separation behavior. The separation behavior of sandwich model HS-3, figures F3.10-4(f) and F3.10-5(b), is also believed to be more representative of flight than the separation behavior of model HS-2, figures F3.10-4(e) and F3.10-5(c), for two reasons. First, although model HS-2 was tested with scaled internal venting between the compartments of bay 4 and the SM tunnel, the rest of the SM free volume had been closed. In the HS-3 model test, this vent area had been opened to a realistic value of 60 square inches. Second, the slow pressure buildup before separation of model HS-2 allowed SM tunnel pressure to rise well above the 10-psi limitation required to

prevent CM-SM separation. Pressurization leading to model HS-3 separation was so rapid (20 milliseconds) that SM tunnel pressure remained below the 10-psi limit. The time to failure would scale up to 40 milliseconds for the flight configuration.

Tests with models HS-3 and HS-4 have bracketed the most likely separation conditions. For both tests, internal venting was scaled and diffuser configuration and accumulator pressure were identical. Model HS-3 separated due to an initial air flow of 190 lb/sec through an orifice of 2.85 square inches. Separation was not achieved on model HS-4 when initial air flow was 135 lb/sec through a 2.0-square inch orifice, even though peak pressures of over 35 psi occurred in the oxygen shelf space after 20 milliseconds.

As a part of this study, an analysis has also been carried out at the Langley Research Center to estimate the distribution and time history of pressures within the Apollo 13 service module. Based on these calculations and the experimental results on panel separation, it appears that additional combustion outside the oxygen tank or rapid flashing of ejected liquid oxygen may have occurred to produce panel separation. A report of this analysis can be found in the official file of the Review Board.

Conclusions

Complete separation of one-half scale honeycomb sandwich models of the bay 4 cover panel in vacuum has been demonstrated. Separation was achieved by rapid air pressurization of the oxygen shelf space. Internal volumes and vent areas of the SM were scaled. Separations were obtained with both uniform and nonuniform pressure distributions. The separation resulting from a nonuniform loading that peaks 20 milliseconds after start of pressurization (40 milliseconds full scale) correlates best with hypotheses and data from flight. This particular panel separated in three pieces after an initial tear along the sides that allowed it to open like a door. Inertial loads are a major factor in obtaining complete separation after initial failure.

PART F⁴

MASTER LIST OF TESTS AND ANALYSES

This part presents a listing of tests and analyses grouped according to the following event categories:

Shelf Drop

Detanking

Quantity Gage Dropout

Short Generation

Ignition

Propagation of Combustion

Pressure Rise

Temperature Rise

Pressure Drop

Final Instrument Loss

Telemetry Loss

Tank Failure

Oxygen Tank No. 1 Pressure Loss

Panel Loss

Side Effects

Miscellaneous

MASTER LIST OF TESTS AND ANALYSES

[By Event]

Number (T/A) Location Monitors	Title	Objective - Description	Status - Results - Remarks
"SHELF DROP"			
13-T-55(T) MSC P. Glynn R. Lindley	Tank Impact Test	Determine energy required to produce a dent in tank dome and determine the approximate input g level to tank.	C - May 26, 1970. A load of 7g was required to produce a dent in the tank shelf.
13-T-60 MSC P. Glynn S. Himmel	Quantity Gage Rivet Test	Apply incrementally increasing force to the load rivet supporting the quantity probe concentric tubes until the rivet fails. X-ray the rivet during significant failure stages to show the failure mechanism.	C - April 27, 1970. Shortly after a load of 105 lb was applied, a decrease to 90 lb was noted, indicating a failure. When the load was increased to 120 lb, the rivet failed by bending and subsequently pulling through the probe tubing.
A-92(T) LRC R. Herr R. Lindley	Shock Load Failure Test of Fan Motor Mounting Screws	Determine by test the shock load at which the four 4-40 x 1/4-inch steel fan mounting screws fail.	C - May 8, 1970. The four machine screws started yielding between 2000g and 2500g with complete failure in tension between 4000g and 4200g with an attached 0.875-lb mass.
DETANKING			
13-T-07R3(T) Beech A/C S. Owens K. Heimburg	Apollo 13 Oxygen Detanking Simulation	Determine the effects on the tank wiring and components of the detanking sequence with the Inconel sleeve and Teflon block displaced in the top probe assembly.	ECD - June 18, 1970. Test in progress.

LEGEND: (T) - Test (A) - Analyses C - Completed ECD - Estimated Completion Date TBD - To Be Determined

48-F

MASTER LIST OF TESTS AND ANALYSES

[By Event]

F-85

Number (T/A) Location Monitors	Title	Objective - Description	Status - Results - Remarks
DETANKING			
13-T-08R1(T) MSC C. Propp K. Heimbürg	Bench Test of Oxygen Tank Conduit	Determine whether the electrical loads and pressure cycling during KSC detanking raised the wire temperature in the conduit to damaging levels.	C - May 15, 1970. Maximum temperature of the conduit (at the midpoint) reached 325° F. Pressure cycling of the tank did not raise the temperature significantly. Inspection showed no degradation. Test results will be confirmed by TPS 13-T-07R3(T).
13-T-19(T) NR J. Jones K. Heimbürg	Ground Support Equipment Filter Analysis	Identify contaminants (oil and glass beads) found in GSE filter pads during Apollo 13 oxygen tanking at KSC and determine if the filter material could be responsible for the failure to detank.	C - April 20, 1970. This test showed that the filter assembly did not contribute to the system malfunction. Oxygen-compatible lubricant was found on filter.
13-T-20(T) KSC H. Lamberth K. Heimbürg	Heater Cycle Test at KSC	Determine if the oxygen tank heater cycled during the 7-hour period of prelaunch detanking at KSC.	C - May 1, 1970. Test results indicate that heater cycling would cause voltage drop on other channels. The prelaunch records during detanking show that the heaters did not cycle but remained continuously "on."
13-T-53(T) MSC C. Propp K. Heimbürg	Heater Assembly Temperature Profile	Determine if the heater temperatures could have been high enough during the KSC detanking to degrade the fan motor lead wire insulation. Tests are to be carried out using nitrogen.	C - May 26, 1970. Tests indicate heater surface could reach 1000° F. Wire conduit could reach 750° F. Teflon insulation was damaged. A second detanking test resulted in thermal switch failure in the closed position with 65 V dc applied.

LEGEND: (T) - Test (A) - Analyses C - Completed ECD - Estimated Completion Date TBD - To Be Determined

MASTER LIST OF TESTS AND ANALYSES

[By Event]

F-86

Number (T/A) Location Monitors	Title	Objective - Description	Status - Results - Remarks
DETANKING			
13-T-80 MSC C. Propp H. Mark	Thermostatic Switch Failure Tests	Determine the voltage and current levels at which the thermostatic switches weld shut in the closed position when they attempt to open in response to temperatures exceeding 80° F.	C - June 5, 1970. The thermostatic switches fail to open where currents exceeding 1.5 amps at 65 V dc are passed through them. The heater current used in the special detanking procedure at KSC was 7 amps at 65 V dc, well in excess of the measured failure current.
A-15(T) KSC T. Sasseen E. Baehr	Blowdown Characteristics of Oxygen Tanks	Determine the bleeddown time from 250 psig using GSE at KSC with the proper configuration for one tank and the fill tube completely disconnected for the other tank.	C - May 15, 1970. The test proved that both tanks did depressurize in practically identical times considering the difference in vent lines and back pressure. The test refuted the earlier assumption of a time difference between the different tank configurations. The significance is that blowdown data are not sensitive enough to determine the fill tube configuration.
QUANTITY GAGE DROPOUT			
13-T-30(T) MSC R. Robinson R. Wells	Quantity Gage and Signal Conditioner Test	Determine the signal conditioner response under extreme transient conditions of ambient temperature, determine quantity gage failure indications, and define transient and steady-state energy levels supplied to every possible fault condition.	C - May 22, 1970. The quantity gage signal conditioner deviated less than 0.85 percent under extreme temperature excursions. The response of the gage to various electrical faults was catalogued, and an analysis of the energy level of faults was made. The significance of this test is that it permits interpretation of abnormal quantity gage readings at the time of the accident and eliminates the gage as a probable source of ignition.

LEGEND: (T) - Test (A) - Analyses C - Completed ECD - Estimated Completion Date TBD - To Be Determined

MASTER LIST OF TESTS AND ANALYSES

[By Event]

Number (T/A) Location Monitors	Title	Objective - Description	Status - Results - Remarks
SHORT GENERATION			
13-T-11(T) MSC R. Robinson R. Wells	Fan Motor Inductive Voltage Discharge and Electrical Energy Release	Determine the amount of stored energy released from the fan motor when one power lead is opened.	C - May 7, 1970. The test showed a power release of 0.02 joule. Transient peak voltage of 1800 volts and current of 0.7 amp were measured. These data establish the energy potential from an open circuit failure of a fan motor.
13-T-22(T) MSC G. Johnson R. Wells	Inverter Operational Characteristics	Determine the operating characteristics of the spacecraft ac inverter when operated with three-phase, phase-to-phase, and phase-to-neutral step loads and short circuits.	C - April 20, 1970. Generally, faults introduced on a particular phase gave a voltage reduction on that phase and a voltage rise on the other phases. Clearing the faults gave the opposite response. This information assists in interpretation of flight data.
13-T-23(T) MSC J. Hanaway R. Wells	AC Transient Voltage Signal Duplication	To determine whether bus 2 transients are capable of producing the type of response seen in the SCS auto TVC gimbal command servo signals just prior to the oxygen tank failure.	C - April 22, 1970. This series of tests applied transients to the ac bus that dipped the bus voltage to 105, 95, 85, and 80 volts for durations of 50, 100, and 150 milliseconds. The transient that dipped the voltage to 85 volts for 150 milliseconds, caused a transient of 0.16 degree per second in the SCS signals, which matched the largest transient observed in the flight data. The significance of this is that it allows more precise timing of the duration, and estimation of the magnitude, of possible causes of ignition.

F-87

LEGEND: (T) - Test (A) - Analyses C - Completed ECD - Estimated Completion Date TRD - To Be Determined

NASA — MSC

MASTER LIST OF TESTS AND ANALYSES

[By Event]

Number (T/A) Location Monitors	Title	Objective - Description	Status - Results - Remarks
IGNITION			
13-T-01(T) MSC L. Leger I. Pinkel	Ignition of Fan Motor Winding by Electrical Overload	Determine if overloaded fan motor winding will cause ignition and combustion of the insulation in supercritical oxygen. Initial conditions were 115 volts, 1-amp fuse, current initially 1 amp and increased in 0.5-amp increments.	C - April 24, 1970. Windings were not fused by 400 Hz-5 amps; 8 amps dc fused winding wire. Ignition did not occur. Results were the same in nitrogen and oxygen at 900 psia, -180° F. NR test shows same result.
13-T-13(T) MSC C. Propp I. Pinkel	Spark Ignition Energy Threshold for Various Tank Materials	Determine if an electrical spark generated by tank wiring can ignite selected non-metallic tank materials.	C - May 30, 1970. A single Teflon insulated wire may be ignited with energies as low as 0.45 joule with a spark/arc.
13-T-15(T) ARC L. Stollar H. Mark	Spark Source Ignition in Supercritical Oxygen	Determine if Teflon can be ignited with 115 V ac spark under various conditions in oxygen atmospheres.	C - April 30, 1970. Three tests in oxygen of 50 psig, 500 psig, and 940 psig at ambient temperature showed insulation ignited and burned in all cases. In oxygen at 940 psig and -190° F the Teflon insulation ignited and burned with a 138-psig pressure rise and no noticeable temperature rise.
13-T-21(T) MSC G. Johnson I. Pinkel	One-Amp Fuse Test	Determine the time/current characteristics to blow the 1-amp fuses in the tank fan circuit.	C - April 20, 1970. The fuses blow at the following currents and times: 4 amp - 0.05 second, 8 amps - 0.025 second. These values give approximately 16 joules.
13-T-24(T) MSC C. Propp I. Pinkel	Tank Materials Ignition Test	Exploratory test with electrical overloads and nichrome heaters to determine the ignition and combustion possibilities of tank materials in low and high pressure gaseous oxygen and ambient pressure liquid oxygen.	C - May 30, 1970. Drilube 822 and all of the different types of tank wiring ignited. Nickel wire was only partially consumed in LOX and solder could not be ignited. The power levels required to get ignition were far in excess of the amount available in the tank.

LEGEND: (T) - Test (A) - Analyses C - Completed ECD - Estimated Completion Date TBD - To Be Determined

F-88

MASTER LIST OF TESTS AND ANALYSES

[By Event]

Number (T/A) Location Monitors	Title	Objective - Description	Status - Results - Remarks
IGNITION			
13-T-25(T) MSC P. McLaughlin	Locked-Rotor Motor Fan Test	Determine motor behavior in a locked condition and check possibility of ignition and propagation.	C - April 19, 1970. Two motors were tested in LOX and powered for 2.5 and 1.0 hours, respectively. There was no indication of malfunction such as heating, arcing, or sparking. Posttest measurements showed no degradation of motor wire insulation.
13-T-28(T) MSFC R. Johnson I. Pinkel	Liquid Oxygen Impact Test of Tank Components	Obtain the impact sensitivity data on Ag-plated Cu wire (two sizes), nickel wire, 822 Drilube, and Pb-Sn solder.	C - May 22, 1970. Teflon insulated wire showed no reaction, Drilube 822 had one reaction of 20 tests, 60-40 solder ignited in 7 out of 20 tests. These results indicate that in one-g, Teflon and Drilube are acceptable in LOX from an impact sensitivity standpoint and that 60-40 solder is not acceptable.
13-T-33(T) NR B. Williams I. Pinkel	Spark/Electric Arc Ignition Test	Determine the spark/electric arc ignition characteristics of Teflon and other non-metallic materials in a LOX/GOX environment by simulating specific component failures which could serve as possible ignition sources.	C - April 19, 1970. There was no ignition of the Teflon in the LOX at 1 atmosphere. This test was superseded by later tests.
13-T-34(T) NR B. Williams I. Pinkel	Closed Chamber Spark Ignition Test	Determine the possibility of igniting Teflon on a motor lead wire when the Teflon is penetrated by a grounded knife edge in pressurized LOX while the motor is running.	C - April 20, 1970. This was an early test designed for a quick appraisal and the desired test conditions were not realized.

LEGEND: (T) - Test (A) - Analyses C - Completed ECD - Estimated Completion Date TBD - To Be Determined

NASA - MSC

MASTER LIST OF TESTS AND ANALYSES

[By Event]

F-90

Number (T/A) Location Monitors	Title	Objective - Description	Status - Results - Remarks
IGNITION			
13-T-35(T) NR G. Johnson I. Pinkel	One-Amp Fuse Test	Determine the time/current characteristics of the 1-amp fuses in the tank fan circuit using a spacecraft regulator and inverter.	C - April 19, 1970. Fuses blow at the following times and currents: 0.010 second - 7.3 amps, 0.012 second - 5.0 amps, 0.100 second - 3.1 amps, and 1.00 second - 2.0 amps.
13-T-36(T) NR R. Johnson I. Pinkel	Hot Wire Test of Nonmetallic Tank Materials	Determine if Teflon materials in the tank will ignite with ohmic heating at simulated tank environment.	C - April 20, 1970. This test shows that Teflon sleeving in supercritical oxygen can be ignited by the burn-through of a ni-chrome wire with 7 to 18 joules.
13-T-41(T) MSC R. Bricker I. Pinkel	Failed Wire Over-load Ignition	Determine if a failure or defect in a wire could produce an overload condition with eventual ignition of wire insulation.	C - June 1, 1970. No ignition was obtained where fan motor wire was reduced to one strand with electric current ranging up to 5 amperes. Current-time duration was fixed by quick-blow 1-amp fuse used in fan motor circuit. In a separate test, a 3-amp current was held for 1 minute without ignition.
13-T-42(T) MSC C. Propp I. Pinkel	Ignition Capability of Quantity Gage Signal Conditioners	Determine if the quantity gage signal conditioners can supply sufficient energy to cause ignition in supercritical oxygen.	C - May 18, 1970. Test with signal conditioner showed that it is incapable of generating enough electrical energy to cause ignition of Teflon.
13-T-44(T) WSTF A. Bond I. Pinkel	High Pressure LOX Sensitivity of Metallics with Surface Oxide Penetrations	Determine if a freshly scored or abraded surface of tank metal would provide an environment suitable for initiation of fire under typical LOX tank operating conditions.	ECD - TBD. Tests to start June 5, 1970. Metallic materials will be 1100Al, 2024T-3Al, and 3003Al. Tests will be extended to include Alcoa AMS-3412 brazing flux.

LEGEND: (T) - Test (A) - Analyses C - Completed ECD - Estimated Completion Date TRD - To Be Determined

MASTER LIST OF TESTS AND ANALYSES

[By Space]

F-91

Number (T/A) Location Monitors	Title	Objective - Description	Status - Results - Remarks
IGNITION			
13-T-62(T) ARC T. Canning H. Mark	Ignition Test of Teflon Submerged in LOX	Determine the ignition potentiality of Teflon submerged in LOX from an electrical short.	C - May 4, 1970. This test shows that Teflon can be ignited by a low energy electrical spark (5 ± 3 joules) and gives sustained temperatures great enough to melt through the test fixture, ceramic feed-throughs and cause pressure increases.
13-T-68(T) ARC J. Parker H. Mark	Flow Reactor Test	Determine the effect of flowing oxygen over a heated polymer.	C - May 4, 1970. The initial stage of degradation follows a first-order process. The temperature at which spontaneous ignition occurs is 500° C.
13-T-69(I) ARC J. Parker H. Mark	Arc Test of Tank Materials Submerged in LOX at One Atmosphere	Determine ignition energy required from a short circuit to cause ignition in atmospheric oxygen.	C - May 4, 1970. All materials could be ignited but burning was very marginal. Ignition energy under these conditions was not determined.
13-T-70(T) ARC J. Parker H. Mark	Ignition Test on Tank Materials in High-Pressure LOX	Determine the ignition energy required from a short circuit to cause ignition in high-pressure LOX.	C - May 4, 1970. The test indicated that spark energies of 2.5 joules would ignite Teflon and initiate a metal-Teflon reaction.
PROPAGATION OF COMBUSTION			
13-T-04R2(T) NR/MSC/KSC E. Tucker I. Pinkel	Sample Analysis of Residual Oxygen in S/C 109 Surge Tank	Determine the contaminants present in the residual oxygen in the surge tank as an aid in identifying the possible source of combustion.	C - May 30, 1970. Tests showed trace contaminate level had not changed from that of original tank fill.

LEGEND: (T) - Test (A) - Analyses C - Completed ECD - Estimated Completion Date TBD - To Be Determined

MASTER LIST OF TESTS AND ANALYSES

[By Event]

Number (T/A) Location Monitors	Title	Objective - Description	Status - Results - Remarks
PROPAGATION OF COMBUSTION			
13-T-06(T) MSC R. Bricker I. Pinkel	Ignition of Oxygen Tank Metals by Burning Teflon	Determine if burning Teflon can ignite metals at cryogenic conditions and attempt to ignite quantity probe aluminum tube by igniting the probe wires.	C - May 27, 1970. Iron, Inconel, and aluminum were ignited by burning Teflon in a series of tests. A separate test showed that a flame propagating along Teflon insulation will enter the quantity probe insulator. Posttest examination showed that about a 2-inch diameter hole had burned through the 3/8-inch thick stainless steel tank closure plate.
13-T-12(T) MSC R. Bricker I. Pinkel	Propagation Rates of Ignited Teflon Wire Insulation and Glass-Filled Teflon	Determine the flame propagation rate of various forms of Teflon used in the oxygen tank.	C - May 15, 1970. Flame propagation rate for Teflon insulation in 900 psia/-180° F oxygen was 0.2 to 0.4 in/sec downward. In 900 psia/75° F oxygen, Teflon gives 0.4 to 0.9 in/sec downward and 2 to 10 in/sec upward, and glass-filled Teflon gives 0.09 to 0.17 in/sec downward.
13-T-18(T) NR E. Tucker I. Pinkel	Inspection and Contamination Analysis of CM Oxygen System Components - S/C 109	Determine the contaminants present and damage incurred in components of the oxygen system as an aid in identifying the source and extent of the anomaly.	ECD - TBD. Work in progress. Laboratory analysis of contaminants in oxygen system components is to begin June 18, 1970.
13-T-48(T) MSC A. Bond I. Pinkel	Comparison of Un-colored and Color-Filled Teflon Flame Propagation Rates	Determine the electrical conductivity and the flame propagation of colored, un-colored, and fingerprint-contaminated Teflon.	C - May 15, 1970. This test was done under TPS 13-T-12. The fingerprint portion will be done at a later date.

F-92

LEGEND: (T) - Test (A) - Analyses C - Completed ECD - Estimated Completion Date TBD - To Be Determined

MASTER LIST OF TESTS AND ANALYSES

[By Event]

F-93

Number (T/A) Location Monitors	Title	Objective - Description	Status - Results - Remarks
PROPAGATION OF COMBUSTION			
13-T-49(T) LeRC A. Bond I. Pinkel	Teflon Flame Propagation in Zero-g	Determine the propagation rates for fan motor and temperature sensor wire bundle at zero-g for comparison with data from tests performed at one-g.	ECD - June 17, 1970. Zero-g flame propagation rate over fan motor wire bundles in clear Teflon sleeving is 0.12 in/sec and in white pigmented sleeving 0.15 to 0.32 in/sec. Measurement of zero-g flame propagation rate along wire in oxygen tank conduit to start June 10.
13-T-56(T) MSC R. Bricker I. Pinkel	Teflon Spark Ignition	Determine the ignition energy of a variety of Teflon materials not associated with Apollo 13.	ECD - August 1, 1970.
13-T-57(T) MSC R. Bricker I. Pinkel	Teflon Propagation Rates	Determine the bounds of Teflon propagation rates in supercritical oxygen.	ECD - August 30, 1970. Tests to start end of June. Tests will establish flame propagation rates for Teflon insulation formulations which differ from present Apollo insulations; to provide possible candidate insulations of reduced fire hazard.
13-T-58(T) MSC C. Propp I. Pinkel	Ignition and Flame Propagation Tests of Fan Motor Lead-Wire System	To determine whether lead wire flame will propagate into fan motor and ignite the interior when immersed in oxygen at 900 psi and -180° F.	C - May 22, 1970. Flame propagates into fan motor house without ignition of any metals or stator windings.
13-T-59(T) MSC C. Propp B. Brown	Oxygen Tank Combustion Propagation Test	Determine the pressure time history curve of an oxygen tank if the lower motor lead wires are ignited between the entrance to the motor and the exit from the heater assembly.	C - June 4, 1970. Ignition point was located at lower fan motor. Flame propagated along wire insulation to tank conduit approximately 1-1/2 as fast as observed in Apollo 13 flight oxygen tank. Tank failure occurred in conduit close to tank closure plate.

LEGEND: (T) - Test (A) - Analyses C - Completed ECD - Estimated Completion Date TBD - To Be Determined

MASTER LIST OF TESTS AND ANALYSES

[By Event]

F-94

Number (T/A) Location Monitors	Title	Objective - Description	Status - Results - Remarks
PROPAGATION OF COMBUSTION			
13-T-63(T) ARC J. Parker H. Mark	Products of Combustion of Teflon in LOX	Determine the principal products of combustion of Teflon in oxygen.	C - May 4, 1970. The principal product of combustion was COF ₂ with an energy release of 121 kcal/mole.
13-T-64(T) LRC J. Hallisay W. Erickson	Propagation Rate of Teflon Combustion in Supercritical Oxygen	Determine the propagation rate of combustion along a wire in supercritical oxygen.	C - June 2, 1970. Test gives downward propagation rate of 0.25 in./sec for a single black wire.
13-T-67(T) ARC J. Parker H. Mark	DTA on Motor Components	Perform a differential thermal analysis on aluminum and Teflon in air.	C - May 4, 1970. This test shows that approximately 79% kcal/mole of heat are released when Teflon, aluminum, and oxygen react.
A-86(A) LRC G. Walberg W. Erickson	Computer Prediction of Products from Oxygen/Teflon Combustion	Compute the flame temperature and major combustion products for a range of oxygen/Teflon ratios and assumed heat losses.	C - May 19, 1970. The maximum flame temperature is 4360° F and the major products of combustion are COF ₂ , CF ₄ , and CO ₂ . F ₂ mole fraction is 0.10 at highest temperature.
13-I-17R1(T)			See Pressure Rise.
13-I-25(T)			See Ignition.

LEGEND: (T) - Test (A) - Analyses C - Completed ECD - Estimated Completion Date TBD - To Be Determined

MASTER LIST OF TESTS AND ANALYSES

[By Event]

F-95

Number (T/A) Location Monitors	Title	Objective - Description	Status - Results - Remarks
PRESSURE RISE			
13-T-17R1(T) MSC C. Propp W. Erickson	Oxygen Tank Wiring Conduit Propagation Rate and Pressure Buildup	Determine the propagation rate of combustion and the pressure increase in the tank conduit filled with supercritical oxygen when the wiring is ignited at the electrical connector end of the conduit.	C - May 17, 1970. Ignition started in conduit behind electrical connector. Conduit ruptured approximately 2 to 3 seconds after ignition.
13-T-26(T) MSC P. McLaughlan F. Smith	Flowmeter Test	Determine the effects of oxygen pressure and temperature variations on flowmeter output to analyze why the flowmeter behavior led the remaining instrumentation in the timeline prior to failure.	C - April 27, 1970. During the ambient temperature test a step pressure increase would result in a spike in the flowmeter output but the flowrate indication would not show any other change. At low temperatures an increase or decrease in pressure would give an indicated corresponding change in flow. At constant pressure a temperature change would give an indicated flow change. All of these effects were known and the data do not have to be corrected for any unexpected behavior of the flowmeter.
13-T-46(T) ARC A. Bond F. Smith	Filter Clogging by COF ₂	Determine if the oxygen tank filter can be clogged by COF ₂ snow.	ECD - TBD. This test has not yet been conducted.
B-62(T) MSC C. Propp E. Cortright	Simulated Tank Fire	Investigate pressure-temperature profiles and propagation patterns within a closely simulated oxygen tank with various ignition points.	This test was conducted under TPS 13-T-59.

LEGEND: (T) - Test (A) - Analyses C - Completed ECD - Estimated Completion Date TBD - To Be Determined

MASTER LIST OF TESTS AND ANALYSES

[By Event]

F-96

Number (T/A) Location Monitors	Title	Objective - Description	Status - Results - Remarks
PRESSURE RISE			
A-87(A) MSC/LRC R. Ried/ G. Walberg W. Erickson 13-T-37(T)	Energy Required to Account for Observed Pressure Rise	Determine the energy required to explain the observed pressure rise in oxygen tank no. 2. An isentropic compression of the oxygen is considered as well as a constant density process with heat addition.	C - May 19, 1970. The minimum energy required (isentropic) is about 10 Btu and the maximum (constant density) is about 130 Btu. See Final Instrument Loss.
TEMPERATURE RISE			
13-T-38(T) B-62(T)			See Final Instrument Loss. See Pressure Rise.
PRESSURE DROP			
13-T-02(T) MSC C. Propp V. Johnson	Relief Valve Blow-down Investigation	Determine the differential pressure between a simulated oxygen tank and the flight pressure transducer as a function of a mass flow through the relief valve. Also determine the response of the flight transducer to a step pressure stimulus.	C - April 27, 1970. The maximum pressure difference between the tank and the flight transducer was 9 psig at a flow rate of 182 lb/hr. The pressure stimulus of 75 psi was transmitted to the flight transducer in 24 milliseconds and reached 100 percent of the step pressure in 57 milliseconds. This test shows that the flight transducer will follow the system pressure under high flow rates and step pressure increases and will not introduce significant errors in the TM data.

LEGEND: (T) - Test (A) - Analyses C - Completed ECD - Estimated Completion Date TBD - To Be Determined

MASTER LIST OF TESTS AND ANALYSES

[By Event]

F-97

Number (T/A) Location Monitors	Title	Objective - Description	Status - Results - Remarks
PRESSURE DROP			
13-T-16(T) Parker A/C W. Chandler V. Johnson	Relief Valve Flow Tests	Determine the flow rate of the relief valve at temperatures from 360° R to 1060° R.	C - May 15, 1970. The flow rate at these temperatures ranged from approximately 0.016 to 0.034 lb-m/sec. This is greater than is required to produce the observed pressure drop.
13-T-27(T) MSC P. Crabb N. Armstrong	Oxygen Relief Valve System Simulation at 80° F	Determine the pressure drop between the filter and the relief valve, and the flight pressure transducer response to a step pressure increase.	C - April 21, 1970. The maximum recorded pressure drop between the simulated tank and pressure transducer was 18 psi. A 500-psi step increase in the "tank" was measured by the pressure transducer with a delay of about 100 milliseconds. This test indicates that under conditions of warm gas and an open filter, the pressure transducer will follow actual tank pressure with reasonable accuracies in magnitude and time.
13-T-31(T) Parker A/C L. Johnson S. Himmel	Relief Valve Flow Rate	Determine flow rate through a fully open relief valve.	C - April 21, 1970. The crack pressure of the valve was 1005 psig and it was fully open at 1010 psig. The maximum flow rate of GOX was 34.5 lb/hr and 108 lb/hr for LOX.
A-24(A) MSC W. Chandler F. Smith	Oxygen Tank Filter	Determine flow rates and pressure drops through lines and filter to account for those pressure measurements noted during the flight. Consider the case of a completely clogged filter.	C - May 14, 1970. The analysis showed that if the filter had been clogged, the rate of pressure drop would have been much greater than that observed in the data. Analysis shows that the pressure relief valve can reduce the oxygen tank pressure at the rate shown in the telemetry data.

LEGEND: (T) - Test (A) - Analyses C - Completed ECD - Estimated Completion Date TBD - To Be Determined

MASTER LIST OF TESTS AND ANALYSES

[By Event]

Number (T/A) Location Monitors	Title	Objective - Description	Status - Results - Remarks
PRESSURE DROP			
A-55(A) MSC W. Rice N. Armstrong	Premature Relief Valve Opening	To determine if a premature relief valve opening would account for the 15 seconds of constant tank pressure after the initial pressure rise, assuming several gas temperatures.	C - May 14, 1970. This analysis showed that the relief valve flow would have caused a pressure drop, not a plateau.
13-T-71(T)			See Tank Failure.
FINAL INSTRUMENT LOSS			
13-T-37 Beech A/C R. Urbach R. Wells	Pressure Transducer Test	Determine the pressure transducer output characteristics at extremely low temperatures.	C - April 21, 1970. The pressure transducer gives erratic readings below -250° F. Temperatures in the oxygen tank were always above -190° F.
13-T-38(T) Beech A/C W. Rice	Temperature Sensor Response	Determine the temperature sensor response time in a rapidly changing temperature environment.	C - April 18, 1970. This test gave sensor response rates of 3° to 12° F per second over a range of +60° to -317° F.
A-3(A) MSC G. Johnson J. Williams	Time Tabulation of Alarms	To determine times and causes for caution and warning alarms during the mission.	C - May 14, 1970. These data were used by Panel 1 in their analyses of mission events.

F-98

LEGEND: (T) - Test (A) - Analyses C - Completed ECD - Estimated Completion Date TBD - To Be Determined

MASTER LIST OF TESTS AND ANALYSES

[By Event]

F-99

Number (T/A) Location Monitors	Title	Objective - Description	Status - Results - Remarks
TELEMETRY LOSS			
A-2(A) MSC M. Kingsley J. Williams	High Gain Antenna Signal Loss	To explain the difficulties associated with acquiring high-gain antenna operation at 55 hours 5 minutes into the mission.	C - May 14, 1970. This was not a specific antenna problem which could be isolated to this mission. Previous missions have encountered similar problems. This difficulty is not considered significant to the Apollo 13 incident.
TANK FAILURE			
13-T-29(T) Boeing S. Glorioso B. Brown	Fracture Mechanics Data for EB Welded Inconel 718 in LOX	Determine the fracture toughness and LOX threshold of electron beam welded Inconel 718 tank materials.	C - June 3, 1970. Test results show that a through fracture greater than 3 inches long would be required to cause rupture of the pressure vessel.
13-T-40(T) MSC S. Glorioso B. Brown	Torch Test of In- conel 718	Determine the burn-through tolerance of Inconel 718, by prestressing the specimen to tank operating pressure and burning through the specimen with an oxyacetylene torch.	C - May 18, 1970. The significant result of this test is that fairly large holes must be burned through Inconel 718 to cause catastrophic failure.
13-T-61(T) MSC S. Glorioso B. Brown	Crack Growth of Cracked Inconel EB Welds	Weld specimens (0.125 inch thick) containing cracks will be tested in liquid nitrogen and subjected to a mean stress corresponding to a relief valve pressure in the supercritical oxygen tank with a superimposed cyclic stress equal to that caused by heater operation.	ECD - July 15, 1970.
13-T-71(T) LeRC W. Chandler S. Himmel	Supercritical Oxygen Blowdown Test	Determine the transient thermodynamic process involved in sudden venting of supercritical oxygen to a hard vacuum.	ECD - June 16, 1970. Apparatus being assembled for this test.

LEGEND: (T) - Test (A) - Analyses C - Completed ECD - Estimated Completion Date TPD - To Be Determined

MASTER LIST OF TESTS AND ANALYSES

[By Event]

F-100

Number (T/A) Organization Monitors	Title	Objective - Description	Status - Results - Remarks
TANK FAILURE			
A-30(A) MSC P. Glynn B. Brown	Stress Analysis of Oxygen Tank Neck Areas	To determine whether failures of the oxygen tank neck area might be initiated by the combined effects of pressure and thermal stresses.	C - May 19, 1970. The analysis was performed using three assumptions on thermal inputs. In all cases analysis showed that the conduit would fail rather than the vessel.
A-33(A) MSC P. Glynn B. Brown	Complete Tank Stress Analysis	To provide information on the complete design stress analysis and on the assumption of membrane stress made in the fracture mechanics analysis with particular emphasis on low discontinuity areas.	C - May 13, 1970. Received two cursory stress analysis reports. Factors of safety acceptable for all conditions analyzed.
A-40(T) Boeing Co. P. Glynn B. Brown	Fracture Test on Oxygen Tank	Carry out fracture mechanics tests and analysis of the oxygen tank.	C - June 3, 1970. Test shows that the failure mode of the tank would have probably been leaking and not a rupture.
A-57(T) MSC/Boeing P. Glynn B. Brown	Tensile Test at Low and Elevated Temperatures	Determine the tensile strength of Inconel 718 and EB weld in the temperature range from -320° to +1800° F.	C - May 20, 1970. All information furnished on typical ultimate and yield strength data showed adequate safety margins for pressures reached in tank.
A-59(A) MSC/Boeing D. Ketchik B. Brown	Fracture Mechanics Review of All Apollo Pressure Vessels	To assess the adequacy of previous fracture analyses and to identify areas where additional data are needed.	ECD - June 19, 1970. Analysis is underway.

LEGEND: (T) - Test (A) - Analyses C - Completed ECD - Estimated Completion Date TBD - To Be Determined

MASTER LIST OF TESTS AND ANALYSES

[By Event]

F-101

Number (T/A) Location Monitors	Title	Objective - Description	Status - Results - Remarks
OXYGEN TANK NO. 1 PRESSURE LOSS			
13-T-39(T) Beech A/C W. Rice H. Mark	Oxygen Tank Blow-down	Determine the rate of pressure decay from oxygen tank XTA 00041 through simulated delivery and vent line fracture starting at 78 percent density level, and 900 psig and ending at ambient pressure.	C - April 20, 1970. Vent through delivery line (0.1870D x 0.015W) reached 350 psia in 25 seconds and 160 psia in 600 seconds. Vent through vent line (0.3750D x 0.015W) reached 415 psia in 3 seconds and ambient in 360 seconds.
A-36(A) MSC W. Chandler E. Baehr	Hardware Damage - Tank 1	Determine what hardware damage would be required to explain the loss of pressure from oxygen tank no. 1.	C - May 18, 1970. The analysis shows that a hole from 0.076 inch to 0.108 inch in diameter would be required to explain the pressure loss in tank no. 1.
PANEL LOSS			
13-T-50(T) MSC R. Bricker W. Erickson	Oxygen Impingement Test on Mylar Insulation	Determine if Mylar insulation can be ignited by a jet of hot oxygen.	C - June 5, 1970. The lowest pressure at which the Mylar will burn in a static oxygen atmosphere with flame ignition is 0.5 psia. Impingement of 1000° F and 1200° F oxygen at 80 psia did not ignite the Mylar blanket. (A test is being prepared to attempt to ignite Mylar in the configuration of the oxygen tank area.)
13-T-54(T) NR D. Arabian S. Himmel	Fuel Cell Radiator Inlet Temperature Response Test	Determine thermal response of temperature sensor installed on EPS water-glycol line.	C - May 20, 1970. Results indicate that under no-flow conditions the flight profiles could not be reproduced. Initial response of the temperature sensor occurred in 0.25 second after heat application.

LEGEND: (T) - Test (A) - Analyses C - Completed ECD - Estimated Completion Date TBD - To Be Determined

MASTER LIST OF TESTS AND ANALYSES

[By Event]

Number (T/A) Location Monitors	Title	Objective - Description	Status - Results - Remarks
PANEL LOSS			
13-T-65(T) LRC E. Morgan W. Erickson	One-Half Scale Panel Separation Test	Determine the pressure impulse necessary to cause complete panel separation and determine the mode of failure. A 1/2-scale model of SM bay 4 is used with structurally scaled test panels. Tests are to be run in vacuum with appropriate vent areas. Panel loading is simulated by a rapid pressure pulse.	C - June 2, 1970. Complete separation of 1/2-scale honeycomb panel models in vacuum was demonstrated for a rapid and loaded pressure pulse and for uniform pressure. Separation for nonuniform loading occurred within about 20 milliseconds. Peak pressures that occur in the oxygen shelf space are near 50 psia, 25 psia in fuel cell shelf, and somewhat less than 10 psia in tunnel volume.
13-T-66(T) LRC M. Ellis W. Erickson	Hot Oxygen Impingement on Mylar Ignition Test	Determine if the Mylar insulation blanket will be ignited by a jet of hot oxygen and estimate the rate of combustion.	C - May 18, 1970. Mylar blanket can be ignited by a hot oxygen (1500° F) jet at pressures above 10 psia. Combustion of a 1-foot square sample requires about 15 seconds. More rapid combustion occurs with 70° F at 10 psia oxygen when Mylar is ignited with Pyrofuse.
13-T-75(T) MSFC J. Nunelley W. Erickson	Heats of Combustion of Teflon, Mylar and Kapton	Determine the heats of combustion of Teflon, Mylar, aluminized Mylar, and aluminized Kapton.	C - May 27, 1970. Heats of combustion were: Teflon - 2200 Btu/lb, Mylar - 9850 Btu/lb, Kapton - 10,700 Btu/lb.
13-T-76(T) MSFC C. Key W. Erickson	Threshold Oxygen Pressure for Mylar & Kapton Flame Propagation	Determine the threshold oxygen pressure for flame propagation of Mylar and Kapton films.	C - May 27, 1970. Ignition threshold oxygen pressure ranged from 0.5 to 1.5 psi for both aluminized Mylar and Kapton under static conditions.

F-102

LEGEND: (T) - Test (A) - Analyses C - Completed ECD - Estimated Completion Date TBD - To Be Determined

MASTER LIST OF TESTS AND ANALYSES

[By Event]

F-103

Number (T/A) Location Monitors	Title	Objective - Description	Status - Results - Remarks
PANEL LOSS			
A-65(A) MSC P. Glynn V. Johnson	CM-SM Heat Shield and Attach Fittings Analysis	Determine if there is any reasonable possibility of estimating the pressure loads applied to the bay 4 panel by reviewing the design of the CM heat shield structure and the CM-SM attach fittings.	C - May 22, 1970. Visual inspection of the bolt assembly between the CM-SM interface revealed no thread damage. It is improbable that the bulkhead experienced any structurally significant pressures during the event.
A-68(A) MSC M. Windler W. Hedrick	Panel Trajectory	To determine if the bay 4 panel is in lunar or earth orbit; if so, to investigate the possibility of getting photographs of the panel on some future manned space flight.	C - May 15, 1970. Analysis revealed that the most probable trajectory led to an impact of the panel on the Moon.
A-88(A) LRC G. Walberg W. Erickson	Prediction of Combustion Products from Oxygen/Mylar Oxidation	Compute the flame temperature and major combustion products for an oxygen/Mylar reaction over a range of oxygen/Mylar ratios.	C - May 25, 1970. Flame temperature is 4750° and 5400° F for stoichiometric combustion at 1.5 and 60 psia. For oxygen/Mylar molar ratios of 10, the flame temperature is 2350° and 2400° F at 1.5 and 60 psia. Combustion products are CO ₂ and H ₂ O below 3500° F and include CO and O at the higher temperatures.
A-93(A) LRC R. Trimp W. Erickson	Calculated Pressure Rise in Bay 4 Due to Combustion	Calculate the pressure rise in the oxygen tank shell which could result from various modes of tank rupture. Consider cases with and without combustion.	C - June 8, 1970. A maximum pressure rise of about 9 psia is achieved in the oxygen shell space for no combustion based on initial tank conditions of 900 psia/-190° F and a 2-inch diameter orifice. This pressure occurs at 180 milliseconds after rupture. An estimate with combustion of 0.2 lb _m of Mylar indicates a pressure rise of about 33 psia.

LEGEND: (T) - Test (A) - Analyses C - Completed ECD - Estimated Completion Date TPD - To Be Determined

MASTER LIST OF TESTS AND ANALYSES

[By Event]

F-104

Number (1 A) Location Monitors	Title	Objective - Description	Status - Results - Remarks
PANEL LOSS			
A-94(T) LRC M. Ellis W. Erickson	Mylar Combustion Tests with Supercritical Oxygen in Simulated Shelf Space	Observe the nature of the combustion of Mylar insulation blanket with supercritical oxygen in a simulated shelf space volume. Measure the resulting pressure rise for various modes of ignition and simulated tank rupture.	C - June 6, 1970. Mylar insulation blanket burns completely when ignited by pyrofuse and exposed to oxygen exhausting from a chamber at 900 psia/1900 F. Duration of combustion process is about 2 to 4 seconds. The pressure rise rate with combustion in these tests is about 7 times that measured with no combustion.
A-95(A) LRC R. Trimpi W. Erickson	Analysis of Temperature by Sensors Outside Shelf Space	Use the flight measured temperature-time histories for sensors outside shelf space to estimate the temperature of the gas which flows from shelf space.	C - June 9, 1970. Examination of the temperature-time histories suggests heat addition outside of oxygen tank.
SIDE EFFECTS			
13-T-32(T) NR R. Johnson R. Wells	Fuel Cell Valve Module - Reactant Valve Shock Test	Determine the effect of a high g load on the fuel cell reactant shutoff valves.	C - April 20, 1970. This test showed that the reactant valves shut under lower shock loads than the RCS valves. Since a portion of the RCS valves closed at the time of the incident, the reactant valves probably closed due to the shock loading.
13-T-26(T)			See Pressure Rise.

LEGEND: (T) - Test (A) - Analyses C - Completed ECD - Estimated Completion Date TPD - To Be Determined

MASTER LIST OF TESTS AND ANALYSES

[By Event]

F-105

Number (T/A) Location Monitors	Title	Objective - Description	Status - Results - Remarks
MISCELLANEOUS			
13-T-43(T) MSC C. Propp S. Himmel	Development of Service Procedure for Apollo 14	Develop new operating procedures for ground operations to prevent stratification in the oxygen tanks.	ECD - TBD. Test has not yet been conducted.
13-T-51(T) NR J. Diaz F. Smith	LOX Tank Fan Motor Examination	Identify nonmetallic motor parts and provide information on their usage. Identify surfaces containing Drilube 822 and look for signs of corrosion.	C - May 12, 1970. The motor parts were identified for the use of Panel 1. Drilube 822 was used on threaded areas of the motor housing and mounting hardware. The motor showed evidence of corrosion at areas of contact of dissimilar metals.
13-T-52(T) WSTF M. Steinthal I. Pinkel	N ₂ O ₄ and A-50 Reactivity with Teflon Insulated Wire	Determine the reactivity of Teflon in N ₂ O ₄ and A-50 when arcing or short circuiting occurs.	ECD - June 12, 1970. The overload test has been completed and the arcing test is being prepared. The overload test shows a maximum temperature rise of 2° F and maximum pressure rise of 2 psi. There have been no reactions with either N ₂ O ₄ or A-50.
13-T-72(T) MSC C. Propp H. Mark	Reactivity of Hydrogen Tank Materials	Hydrogen materials will be ignited in gaseous hydrogen at various temperatures. Ignition will be by a nichrome wire electrically heated until failure occurs.	ECD - June 30, 1970. The test has not yet been conducted.
13-T-73(T) MSC C. Propp H. Mark	Spark Ignition Threshold and Propagation Rates for Hydrogen Tank Material in Gaseous Hydrogen	Determine spark ignition threshold and combustion propagation rates for hydrogen tank material in gaseous and supercritical hydrogen at various temperatures.	ECD - June 19, 1970. The test has not yet been conducted.

LEGEND: (T) - Test (A) - Analyses C - Completed ECD - Estimated Completion Date TBD - To Be Determined

MASTER LIST OF TESTS AND ANALYSES

[By Event]

Number (T, A) Location Monitors	Title	Objective - Description	Status - Results - Remarks
MISCELLANEOUS			
13-T-74(T) MSC C. Propp H. Mark	Ignition of Specific Configurations in Hydrogen	Details depend on results of 13-T-72 and 73. Will mockup hydrogen tank configuration.	ECD - July 1, 1970. The test has not yet been conducted.
A-12(T) ARC E. Winkler H. Mark	Teflon/Aluminum Ignition in Inert Atmosphere	Determine whether it is possible to ignite Teflon and aluminum in an inert atmosphere.	J - May 15, 1970. A Teflon and powdered aluminum mixture could be made to burn. High ignition energies (greater than 10 joules) were necessary and it was found that the aluminum had to be finely divided before it would burn.

F-106

LEGEND: (T) - Test (A) - Analyses C - Completed ECD - Estimated Completion Date TED - To be Determined

PART F5

FAULT TREE ANALYSIS - APOLLO 13 ACCIDENT*

INTRODUCTION

This report contains a fault tree analysis of the applicable portions of the electrical power and cryogenic systems involved in the Apollo 13 incident. It was prepared by the Boeing Company under the direction of MSC and at the request of the Apollo 13 Review Board.

PURPOSE

The purpose of this analysis is to identify potential causes that could lead to the loss of the SM main bus power, to show their logical associations, and to categorize them as being true or false for the Apollo 13 incident based upon available data, analyses, and tests. The prime emphasis is to identify the initiating cause, and secondarily, the sequence of events leading to the loss of SM main bus power.

SCOPE

This fault tree identified the applicable ECS/cryogenic system hardware and potential causes, down to the component or groups of components level. The logical association of the potential causes is shown graphically and is developed tracing the system functions backwards. Each potential cause is categorized as being true or false where flight data, ground tests, technical analyses, and/or engineering judgment provide sufficient rationale. The main thread to determine the initiating cause is identified in the fault tree. The tree does not include unrelated or secondary effects of the failure (i.e., quantity gage malfunction, panel blow-off, fire in the service module).

Pages F-108 through F-114 provide information on symbology, terminology, abbreviations, references, and schematics for reference during review of the fault tree. Page F-111 identifies what pages of the fault tree are associated with the various segments of the system. Page F-115 pictorially depicts the required layout of the pages of the fault tree to provide an overview of the complete system.

*Extracted from "Fault Tree Analysis - Apollo 13 Incident," dated June 5, 1970, under Contract NAS 9-10364 - Task Item 9.0, for MSC Apollo 13 Review Board, Action Item 35.

DESCRIPTION OF FAULT TREE DEVELOPMENT PROCESS:

BEGINNING FROM THE DEFINED UNDESIRED EVENT, "FUEL CELL POWER NOT AVAILABLE ON SM BUSES", THE CAUSATIVE FACTORS HAVE BEEN SHOWN BY MEANS OF LOGIC DIAGRAMMING. GIVEN THAT A SPECIFIED EVENT CAN OCCUR, ALL POSSIBLE CAUSES FOR THAT EVENT ARE ARRAYED UNDER IT. IT IS IMPORTANT TO NOTE THAT THIS LISTING INCLUDES ALL POSSIBLE WAYS IN WHICH THE EVENT CAN OCCUR. NEXT, THE RELATIONSHIP OF THESE CAUSATIVE FACTORS TO ONE ANOTHER AND TO THE ULTIMATE EVENT IS EVALUATED AND A DETERMINATION AS TO WHETHER THE DEFINED CAUSES ARE MUTUALLY INDEPENDENT, OR ARE REQUIRED TO COEXIST, IS MADE. THE SYMBOLOGY EMPLOYED TO ILLUSTRATE THE THOUGHT PROCESS IS AS FOLLOWS:



FAILURE/CAUSE STATEMENT - FAILURES ARE SHOWN WITHIN THE LOGIC BLOCKS - TRUE AND FALSE STATEMENTS AND RATIONALE ARE ADJACENT TO THE APPLICABLE BLOCKS.



"OR" GATE - THOSE CAUSES WHICH ARE CAPABLE, INDEPENDENTLY, OF BRINGING ABOUT THE UNDESIRED EVENT ARE ARRAYED HORIZONTALLY BELOW THE "OR" SYMBOLS.



"AND" GATE - THOSE CAUSES WHICH MUST COEXIST ARE ARRAYED HORIZONTALLY BELOW THE "AND" SYMBOLS.

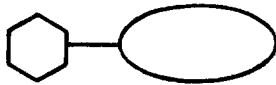

"INHIBIT" GATE - THOSE FACTORS WHICH INTRODUCE ELEMENTS OF CONDITIONAL PROBABILITY, AND WHICH ARE REQUIRED TO COEXIST WITH OTHER CAUSES, ARE DEFINED AS "INHIBIT" FUNCTIONS.



"HOUSE" - THOSE CAUSATIVE FACTORS WHICH ARE NORMALLY EXPECTED TO EXIST, OR TO OCCUR, ARE SHOWN AS "HOUSES".

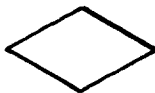

"DIAMOND" - TERMINATED FOR THIS SUB-BRANCH; FURTHER DEVELOPMENT NOT REQUIRED FOR THIS ANALYSIS.



"CUT CORNER" - INDICATES THIS IS A KEY OR NODAL BLOCK. ANALYSIS OF THESE BLOCKS WAS PERFORMED IN GREATER DEPTH SINCE THEY "CONTROL" SIGNIFICANT PORTIONS OF THE FAULT TREE.

TRUTH STATEMENT CATEGORIZATION:

EACH FAILURE STATEMENT IS REVIEWED TO DETERMINE WHETHER IT IS TRUE OR FALSE. THE TYPE DATA USED TO SUPPORT A STATEMENT BEING TRUE OR FALSE IS IDENTIFIED. IN ADDITION, THE SUPPORTING DATA SOURCES ARE REFERENCED.

CODE KEY

<u>CATEGORY</u>	<u>DATA TYPE</u>
F = FALSE	FD = PER FLIGHT DATA
T = TRUE	A = PER ANALYSIS
	GD = PER GROUND DATA
	EJ = PER ENGINEERING JUDGEMENT
	TE = PER TEST
	SL = SUBORDINATE LOGIC (SUPPORTED BY SUB-TIER LOGIC.)

EXAMPLE: F - FD = FALSE PER FLIGHT DATA

REFERENCES:

1. MSC APOLLO INVESTIGATION TEAM PANEL 1, PRELIMINARY REPORT, DATED APRIL 1970
2. APOLLO 13 UNPUBLISHED FLIGHT DATA, AVAILABLE AT NASA/MSC BUILDING 45, 3RD FLOOR, DATA ROOM
3. NASA/MSC TPS 13-T-58, IGNITION OF DESTRATIFICATION MOTOR TEST
4. MSC APOLLO INVESTIGATION TEAM PANEL 1, APOLLO 13 CRYOGENIC OXYGEN TANK 2 ANOMALY REPORT (INTERIM DRAFT), DATED MAY 22, 1970
5. NASA/MSC TPS 13-T-53, HEATER ASSEMBLY TEMPERATURE PROFILE
6. NASA/MSC TPS 13-T-59, OXYGEN TANK IGNITION SIMULATION

LIST OF ABBREVIATIONS

AL.	-	ALUMINUM
ASSY	-	ASSEMBLY
CAP	-	CAPABILITY
CRYO	-	CRYOGENIC
CU	-	COPPER
ECS	-	ENVIRONMENTAL CONTROL SYSTEM
ELEC	-	ELECTRICAL
EOI	-	EARTH ORBIT INSERTION
EPS	-	ELECTRICAL POWER SYSTEM
FAB	-	FABRICATION
FC	-	FUEL CELL
FIG.	-	FIGURE
GEN	-	GENERATE OR GENERATED
H ₂	-	HYDROGEN
H ₂ O	-	WATER
MECH	-	MECHANICAL
MSC	-	MANNED SPACECRAFT CENTER
NASA	-	NATIONAL AERONAUTICS AND SPACE ADMINISTRATION
NEG.	-	NEGATIVE
NO.	-	NUMBER
O ₂	-	OXYGEN
OS-X	-	OXYGEN SUPPLY CONNECTION 1, 2 OR 3
PARA.	-	PARAGRAPH
PRELIM.	-	PRELIMINARY
PRESS	-	PRESSURE OR PRESSURIZED
QTY	-	QUANTITY
REF.	-	REFERENCE
RF	-	RADIO FREQUENCY
S/C	-	SPACECRAFT
SM	-	SERVICE MODULE
STRUCT	-	STRUCTURE OR STRUCTURAL
SYS	-	SYSTEM
TEMP	-	TEMPERATURE

SIMPLIFIED SCHEMATIC OF EPS
AND CRYOGENIC OXYGEN SYSTEM

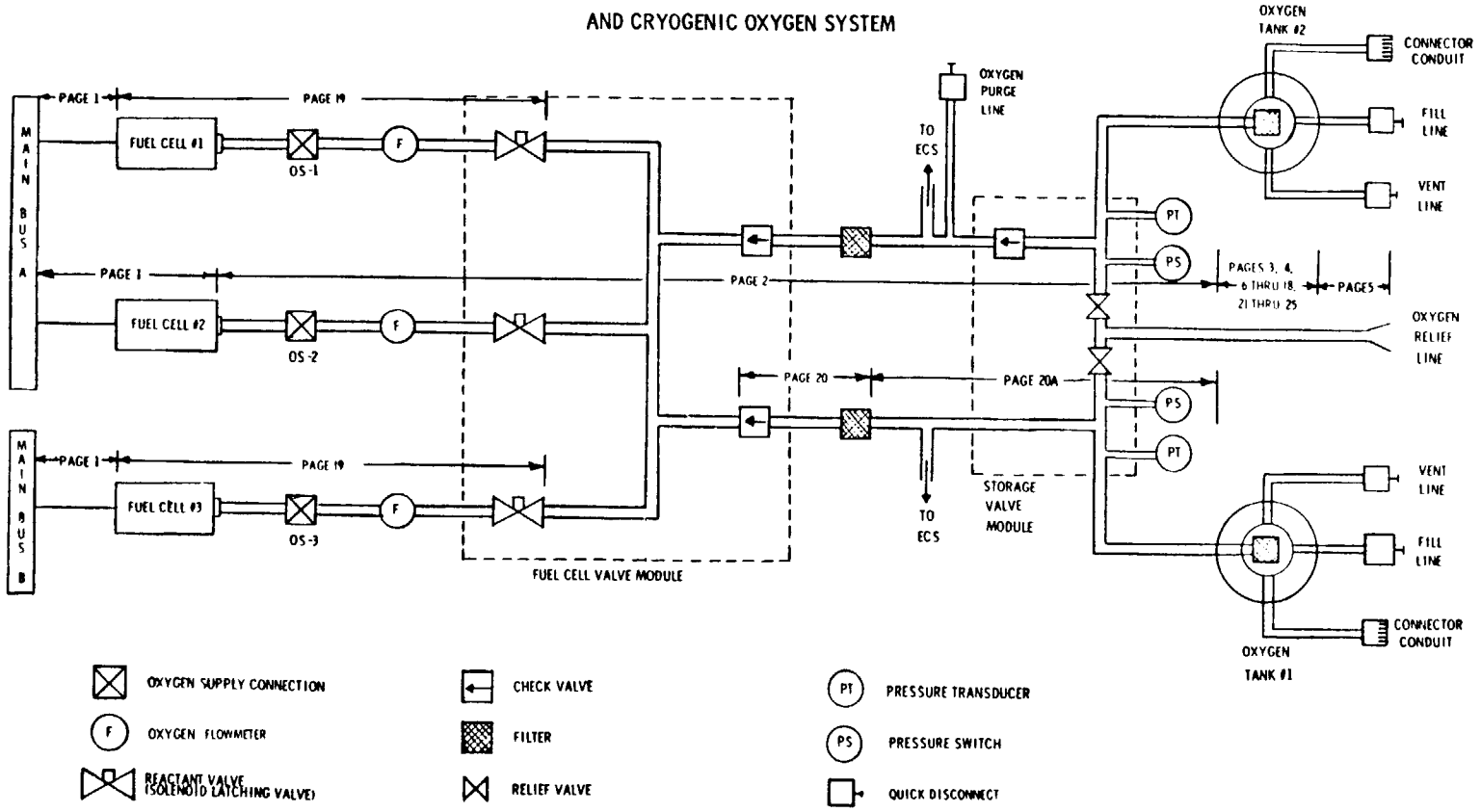

R-1111

F-112

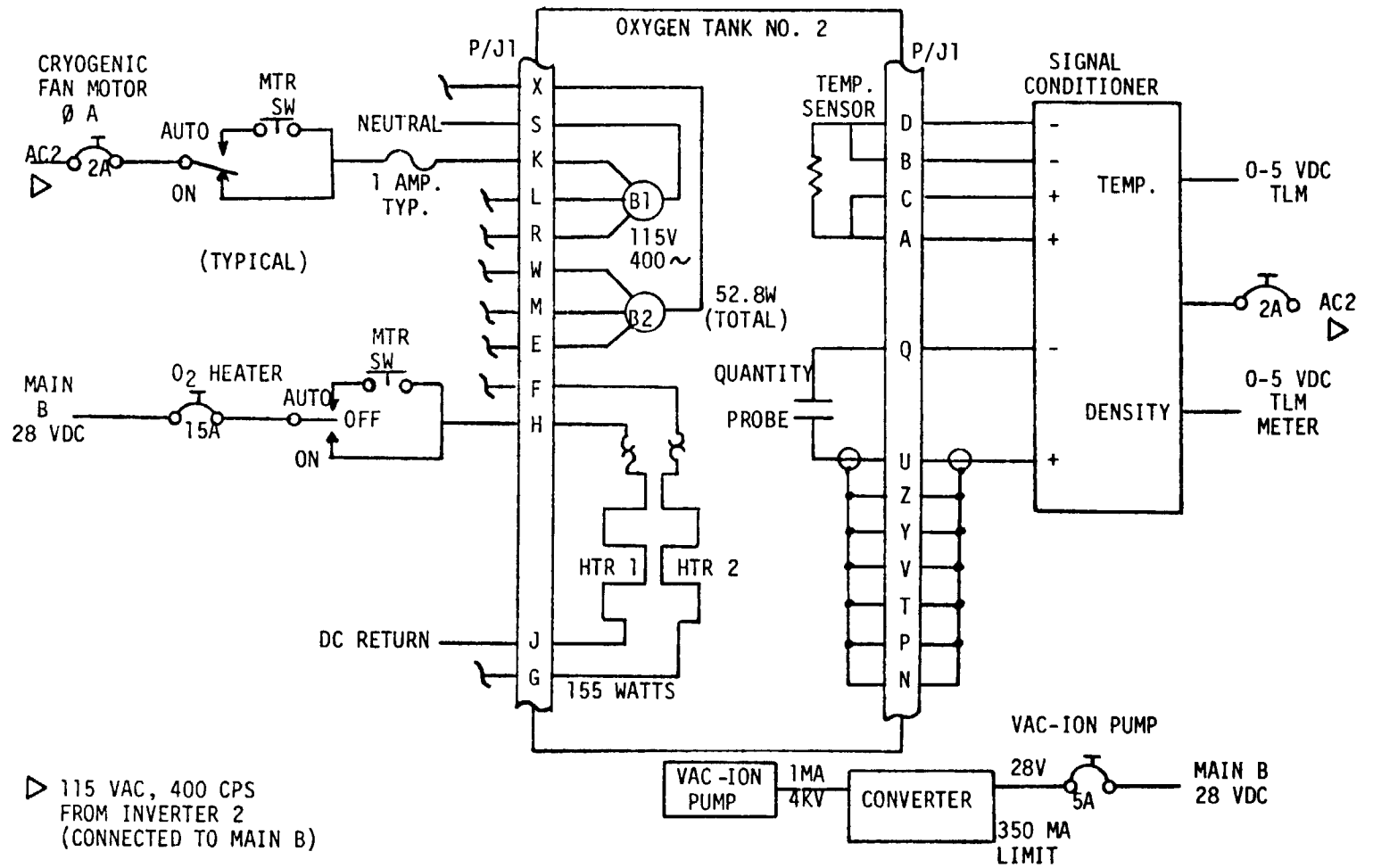

▷ 115 VAC, 400 CPS FROM INVERTER 2 (CONNECTED TO MAIN B)

OXYGEN TANK NO. 2 ELECTRICAL SCHEMATIC

F-113

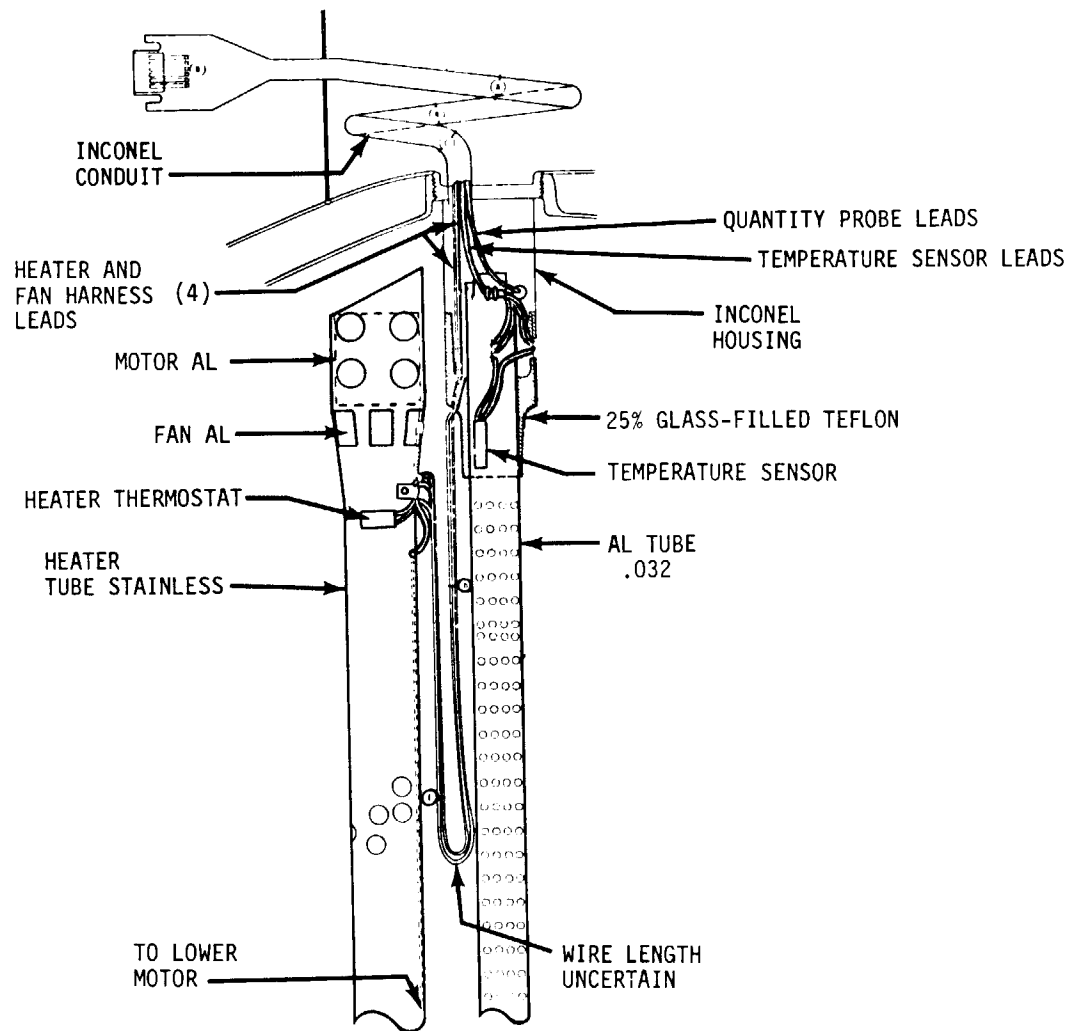

UPPER HEATER AND PROBE ASSEMBLY

F-114

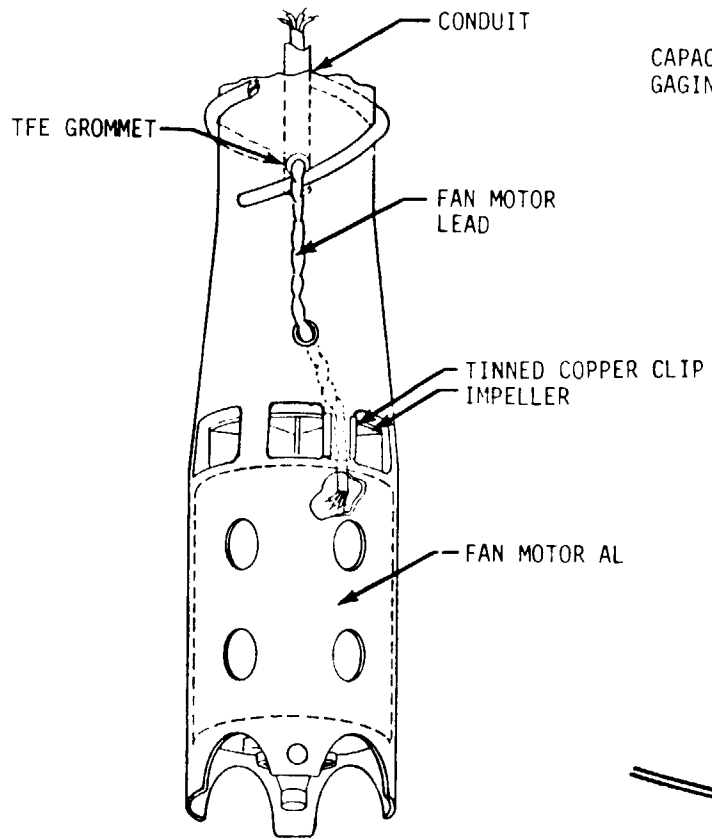

DETAIL OF HEATER ASSEMBLY

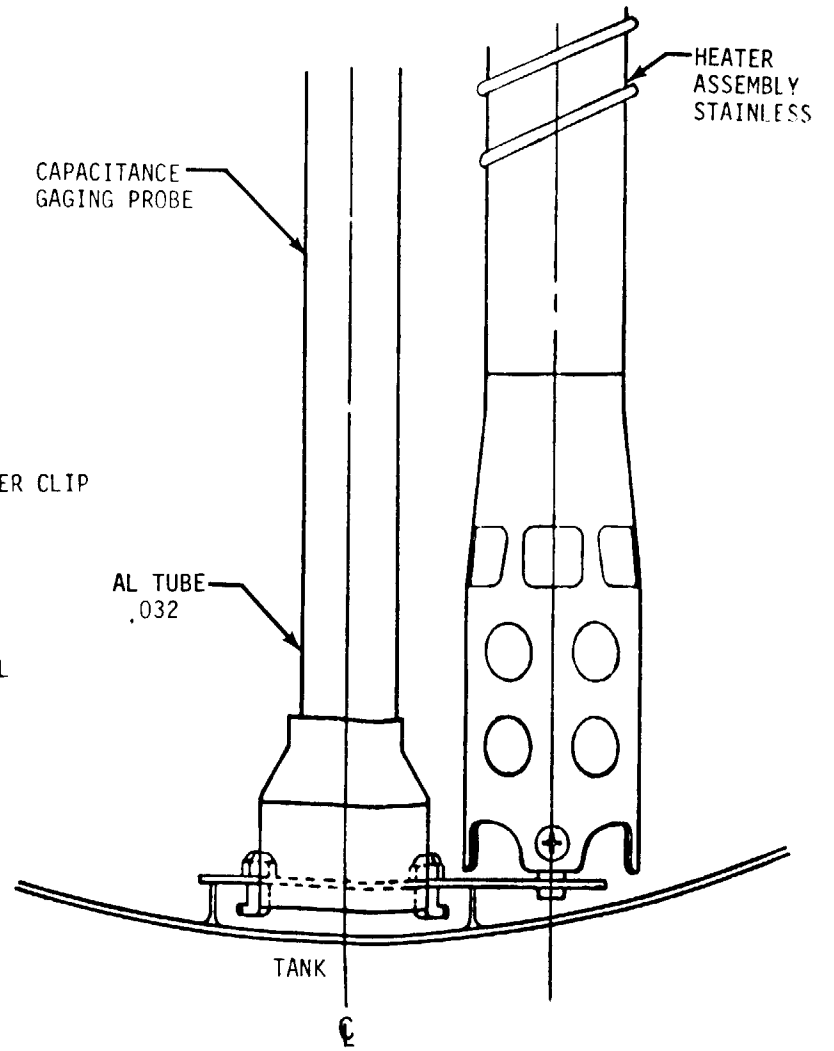

LOWER HEATER AND PROBE ASSEMBLY
viii

FAULT TREE SHEET LAYOUT *

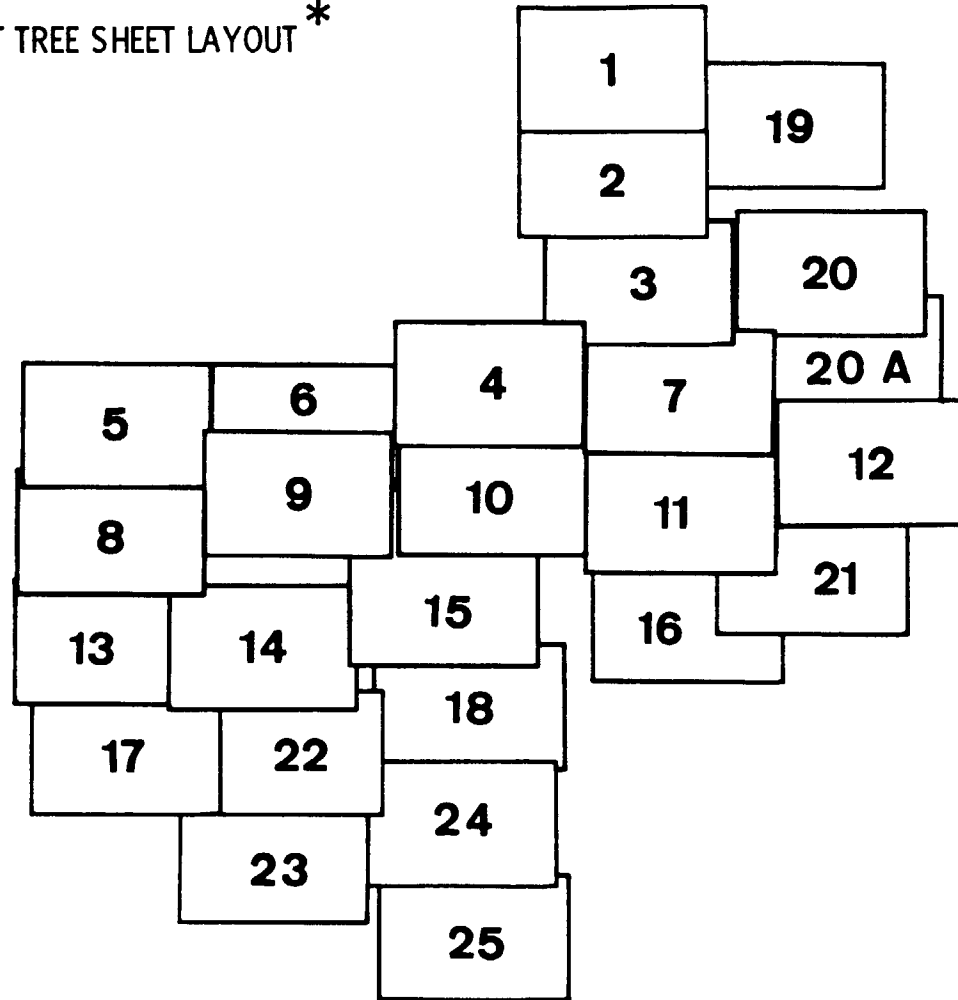

F-115

* TO ASSEMBLE FAULT TREE, LAYOUT PAGES IN THE POSITIONS SHOWN ABOVE

FAULT TREE ANALYSIS

June 5, 1970

||||| MAIN THREAD
..... CONTRIBUTORY BRANCHES

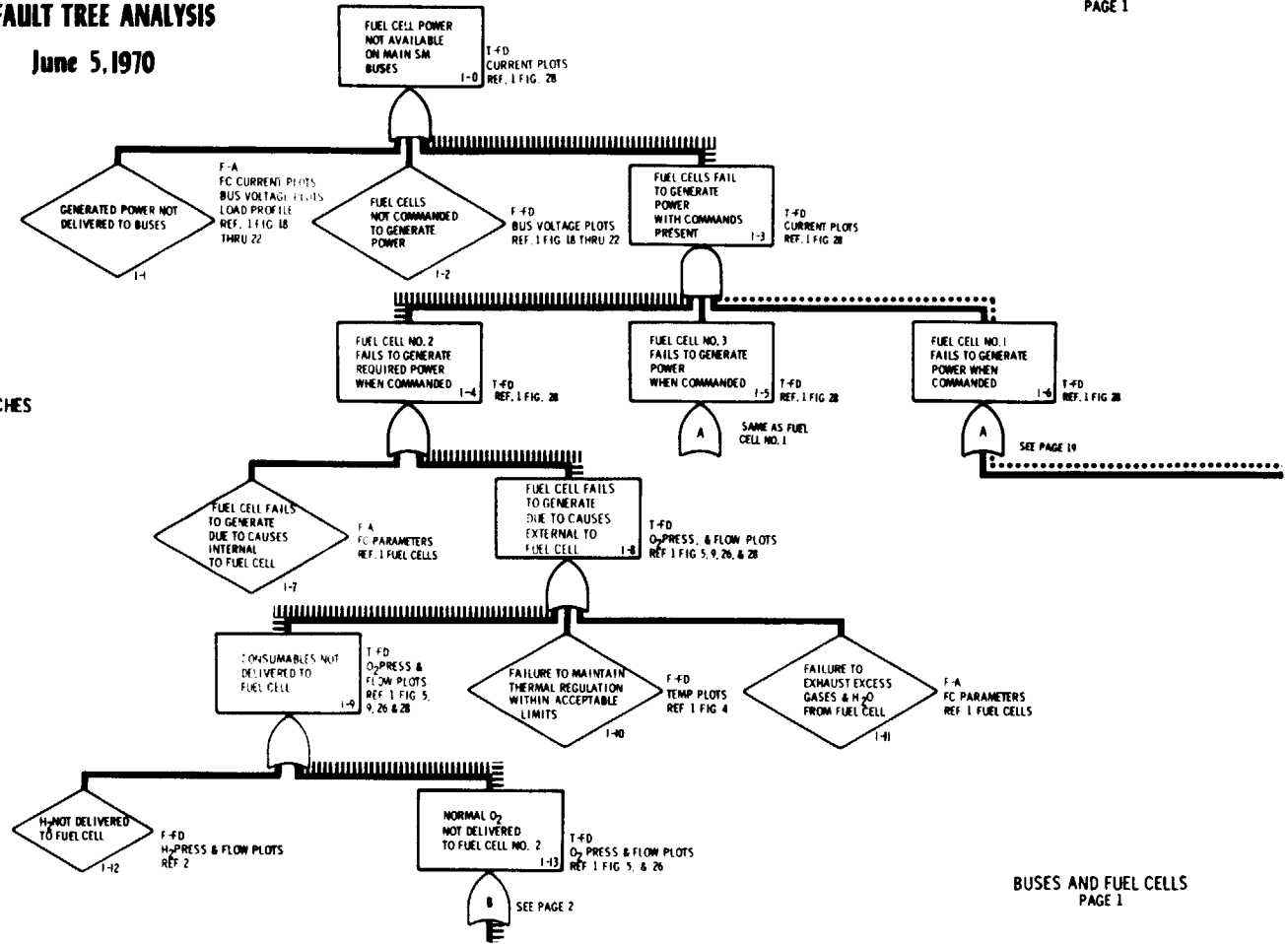

F-116

F-117

FUEL CELL NO. 2 INTERCONNECT SYSTEM PAGE 2

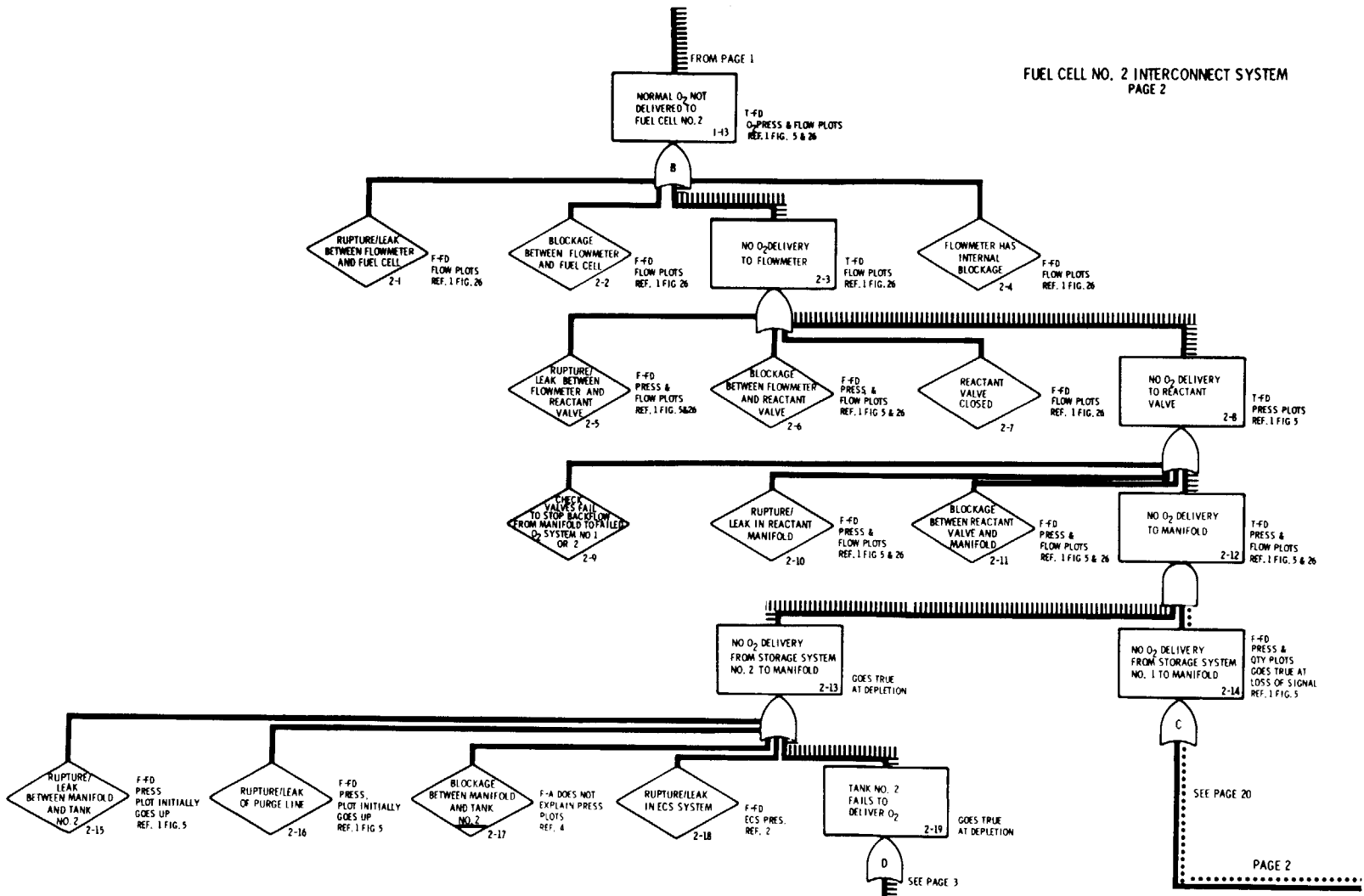

F-120

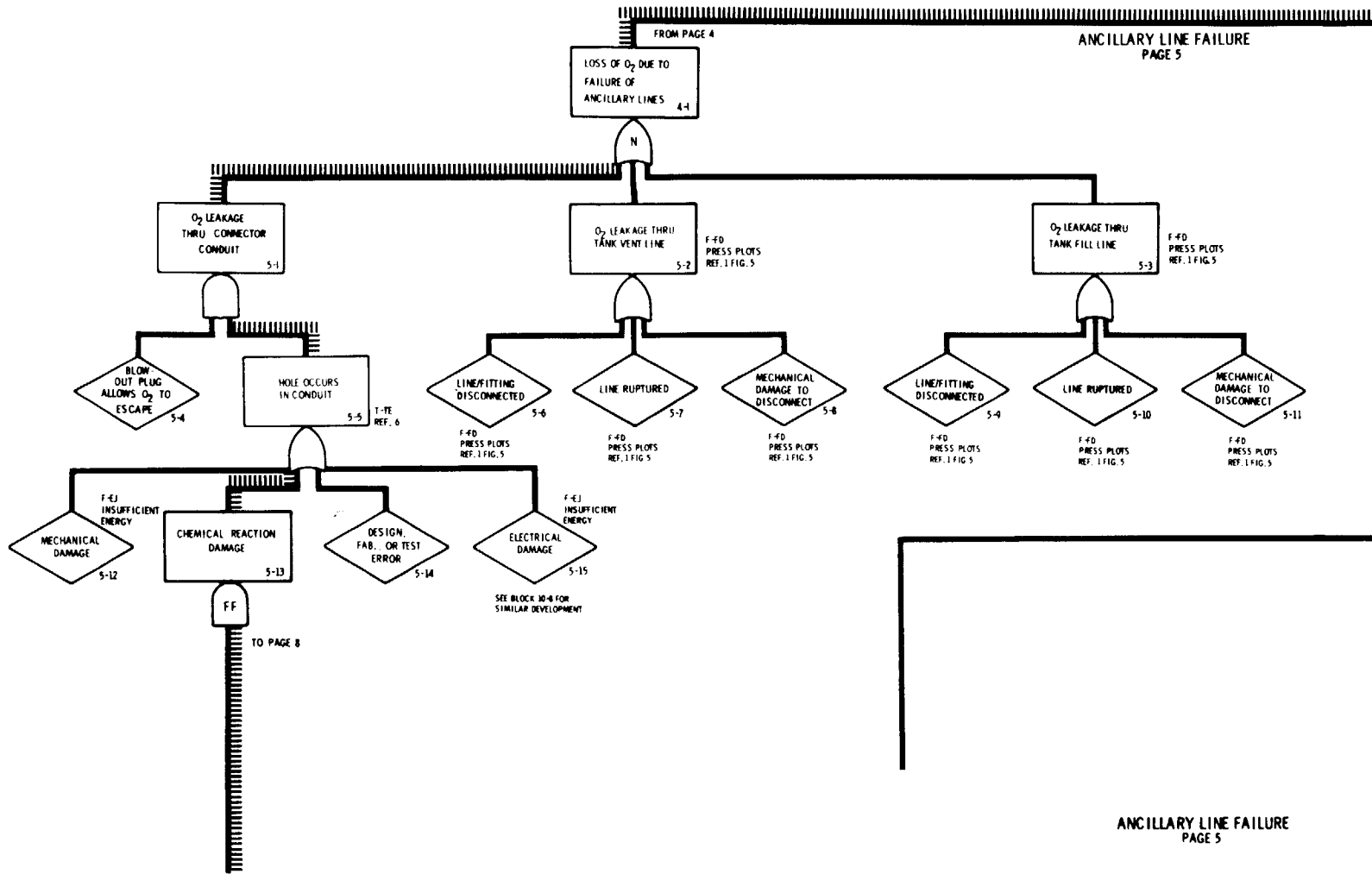

F-121

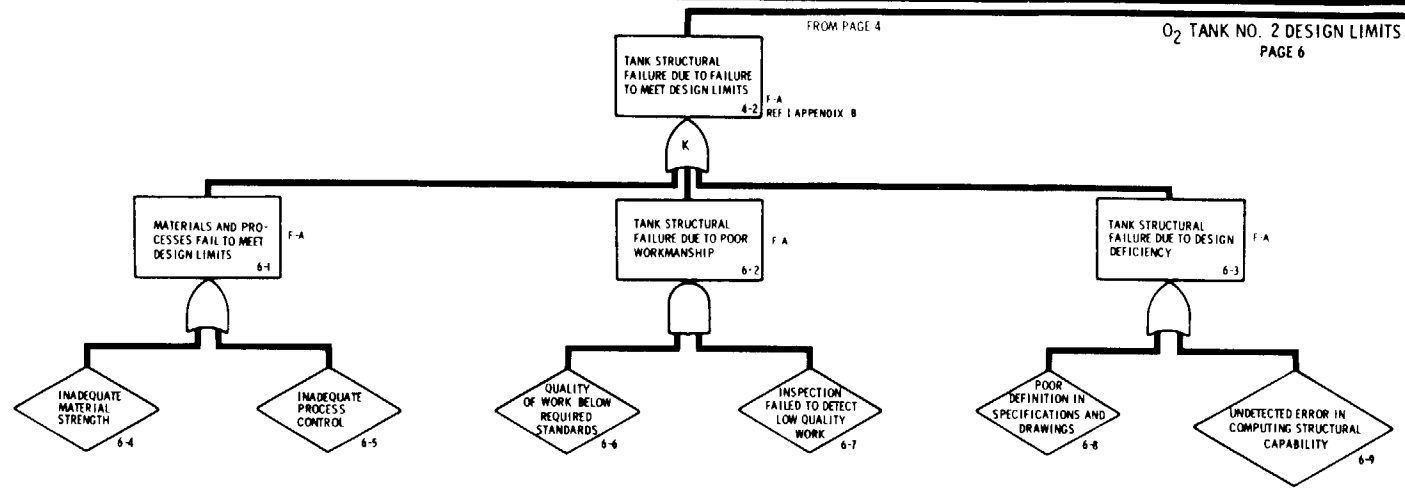

F-122

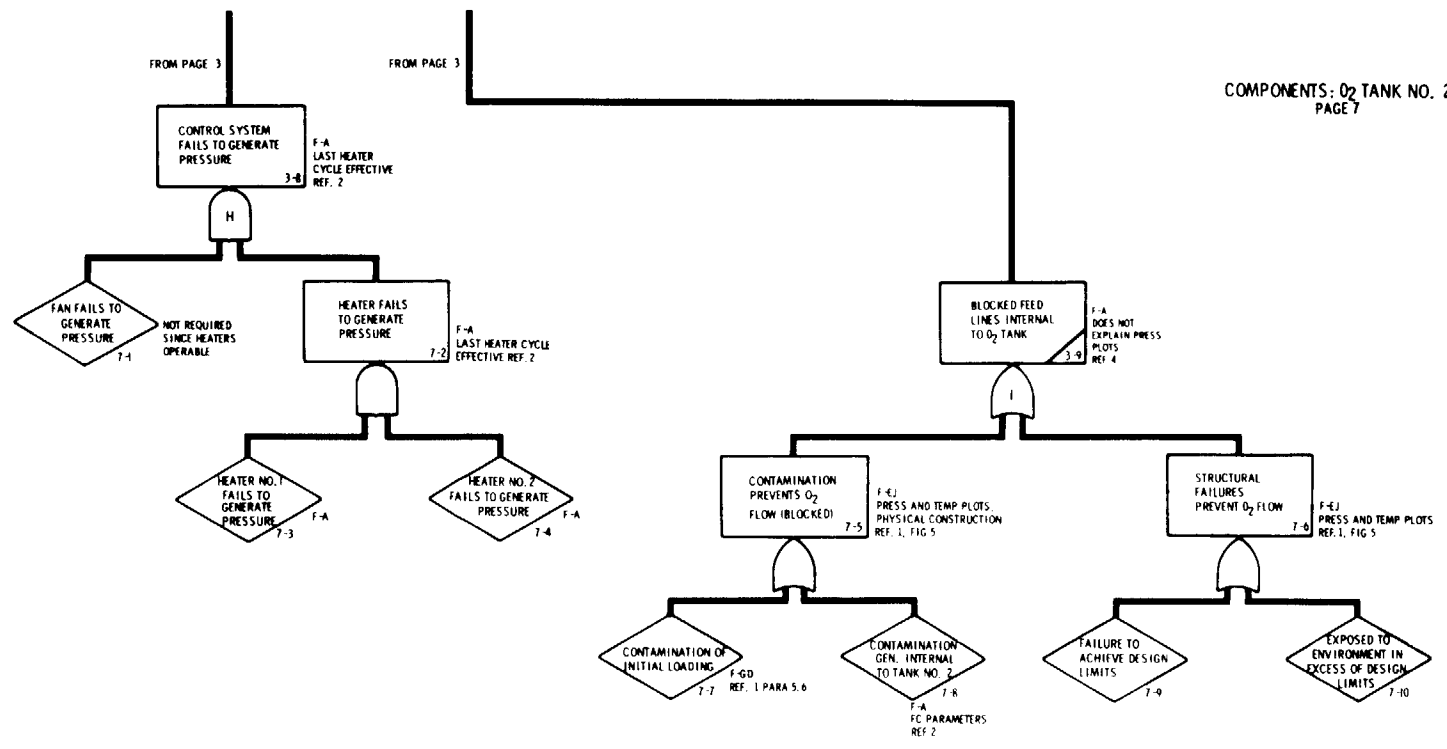

COMPONENTS: O₂ TANK NO. 2
PAGE 7

COMPONENTS: O₂ TANK NO. 2
PAGE 7

F-123

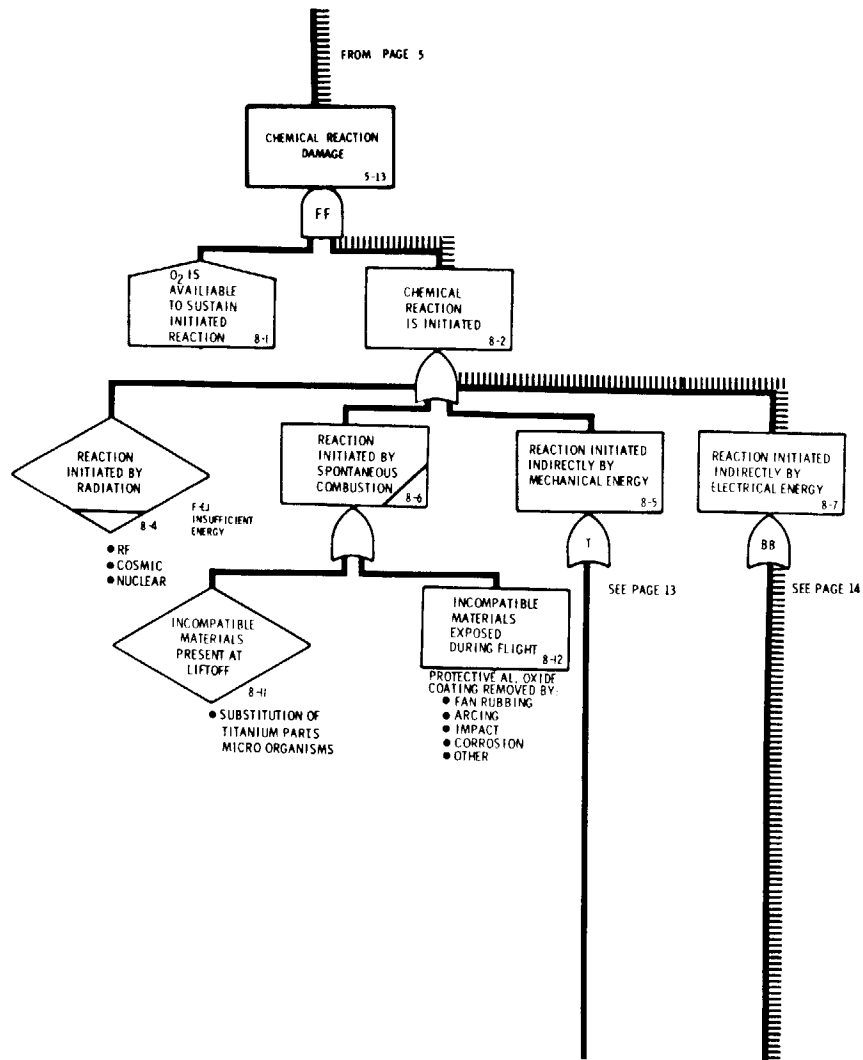

STRUCTURAL CORROSION
PAGE 8

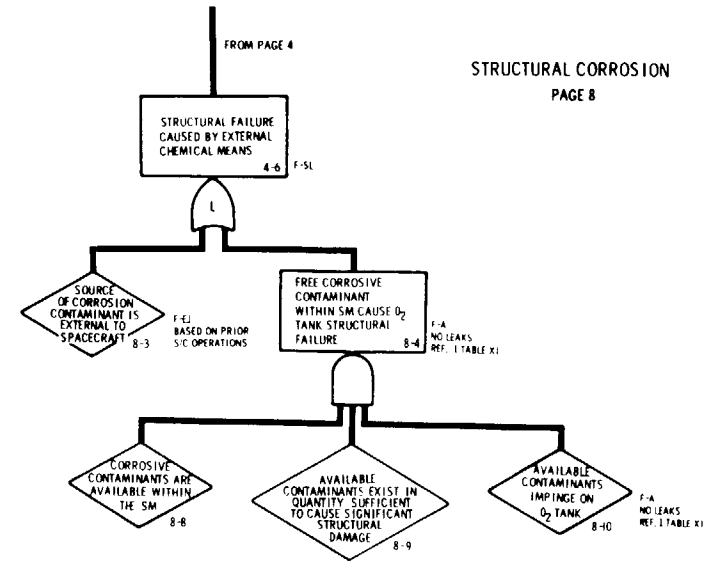

STRUCTURAL CORROSION
PAGE 8

F-124

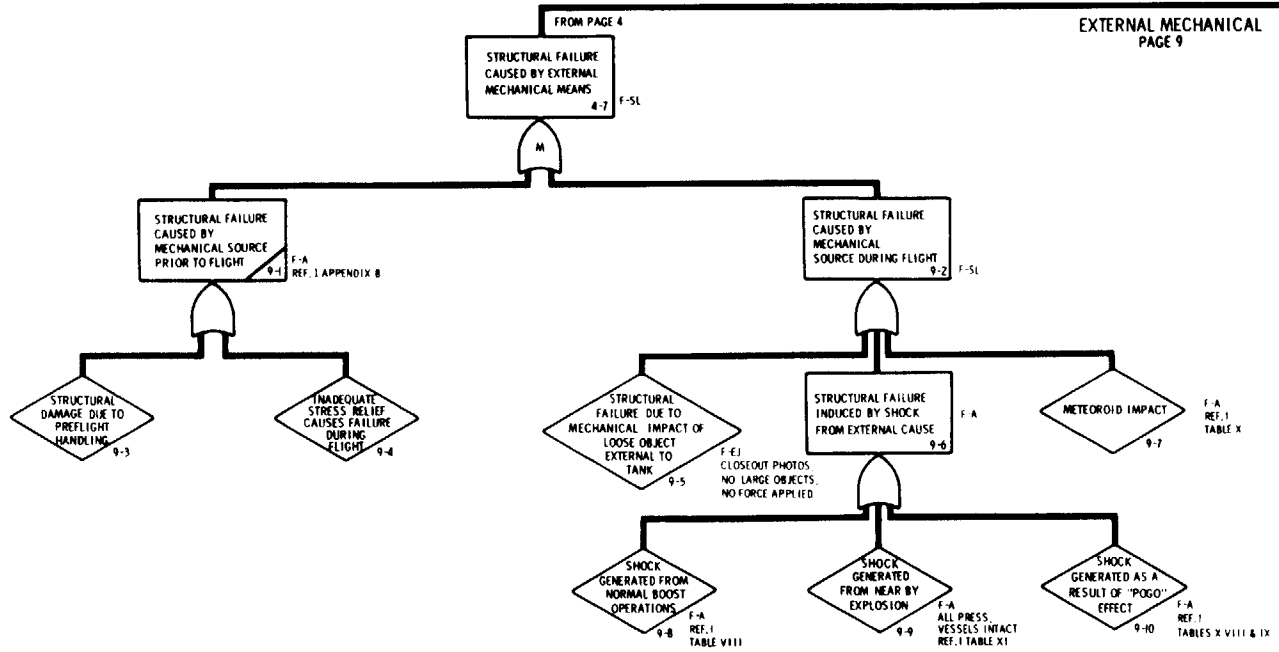

F-125

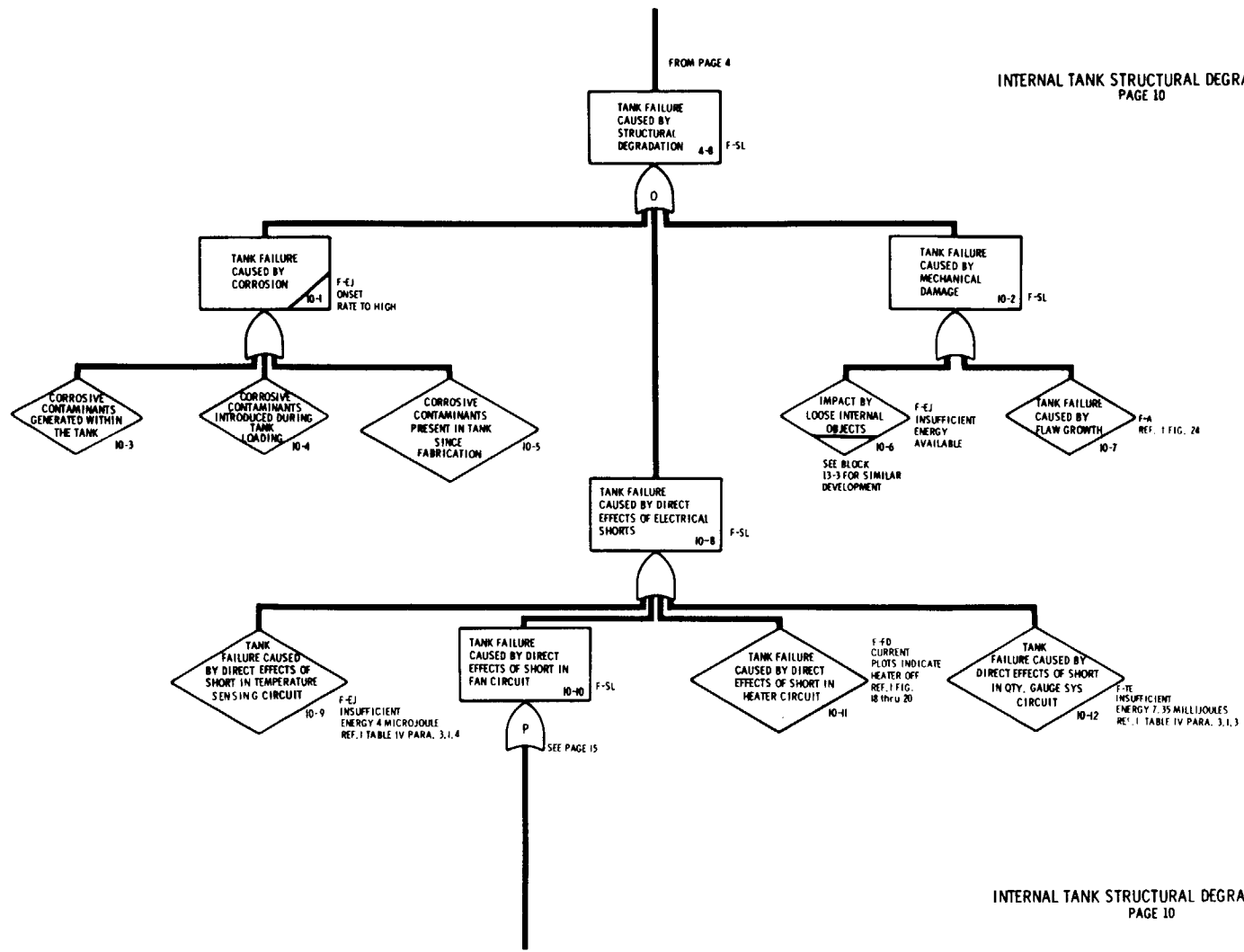

F-126

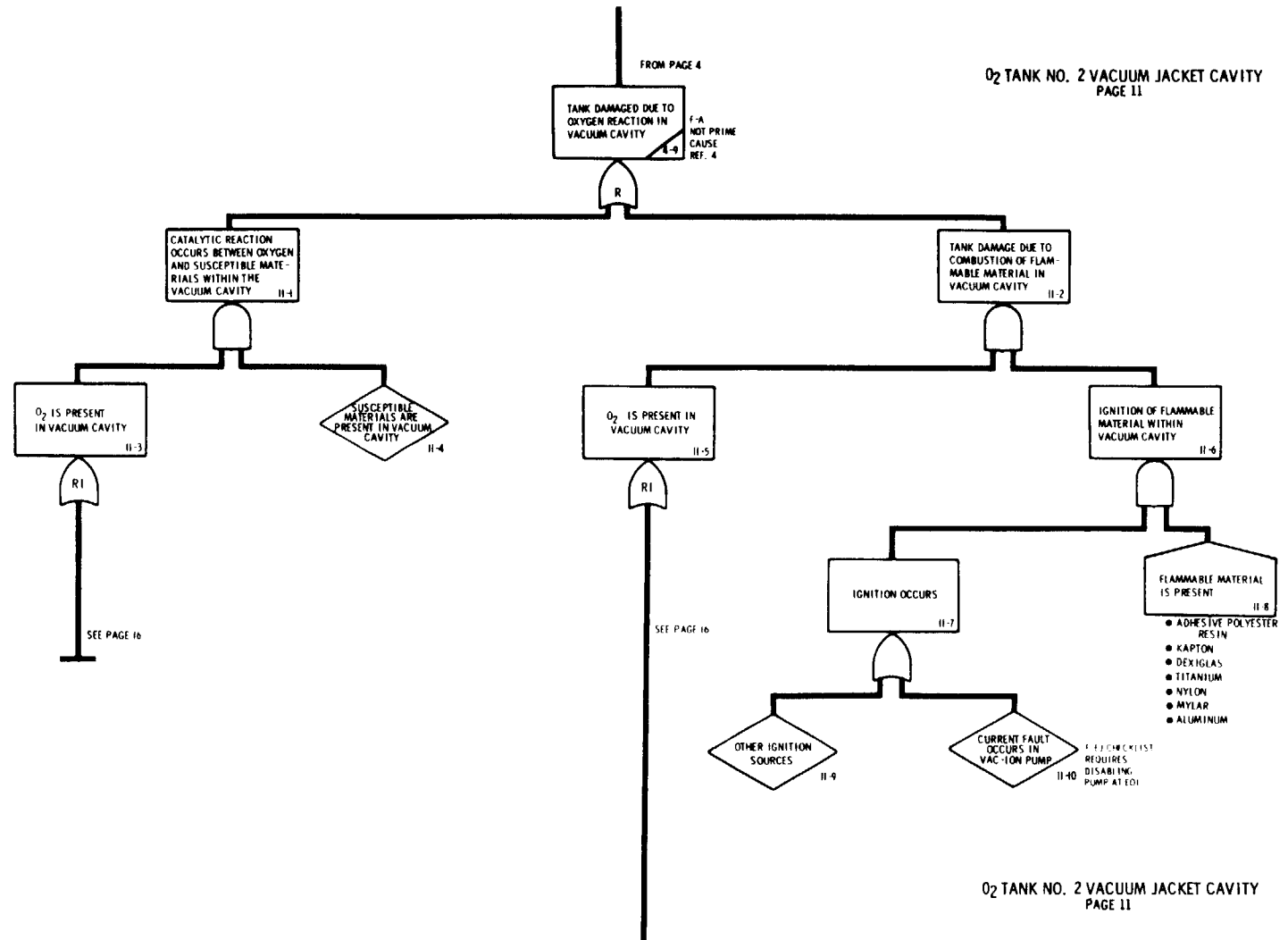

FROM PAGE 4

TANK OVER PRESSURE
PAGE 12

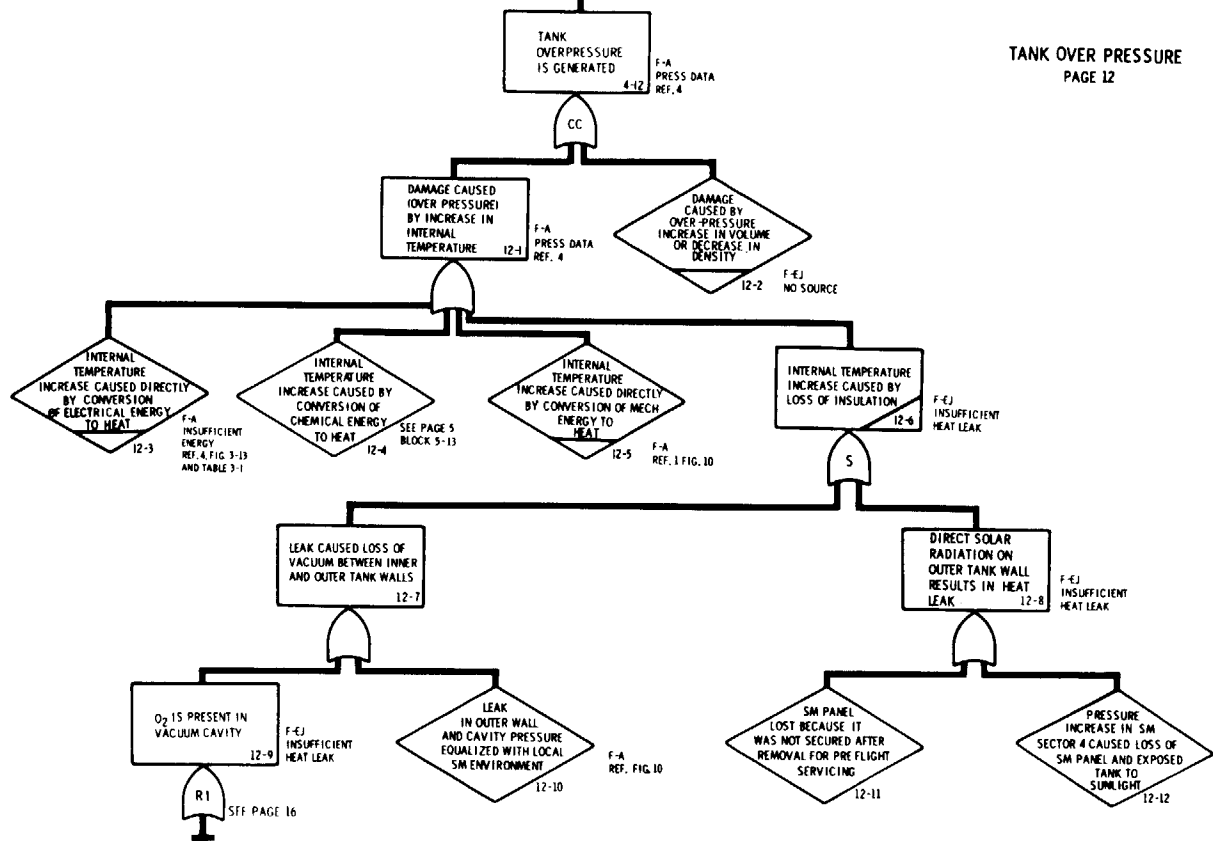

TANK OVER PRESSURE
PAGE 12

F-127

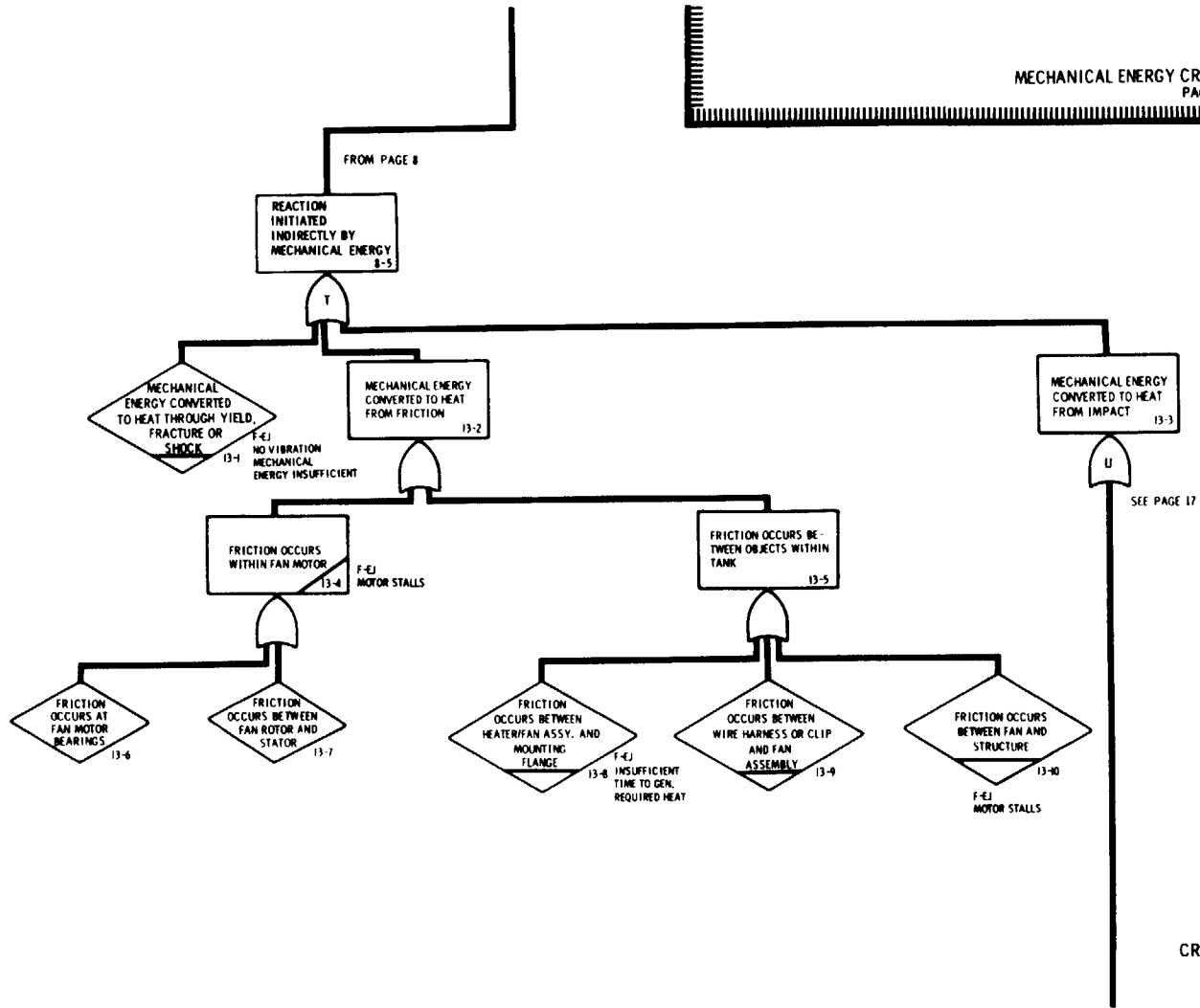

F-128

F-129

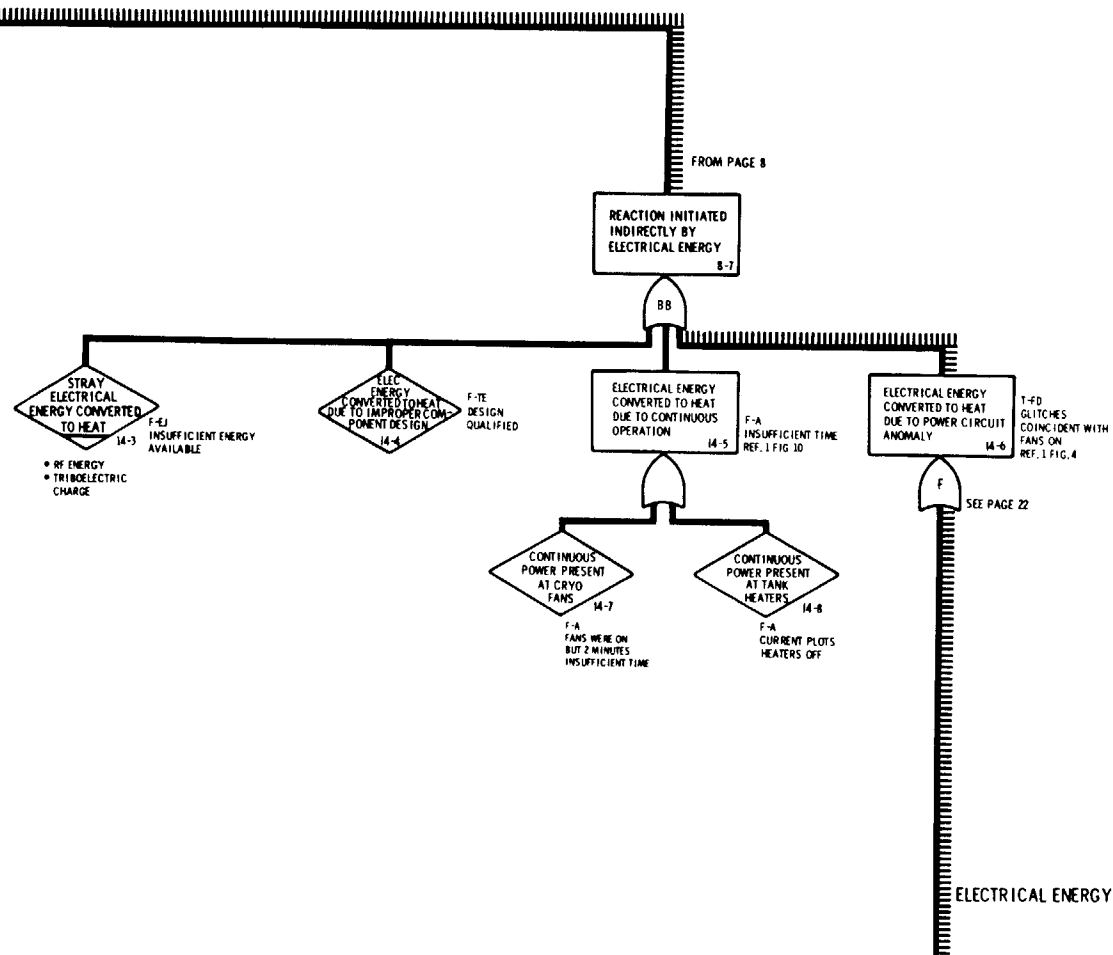

F-130

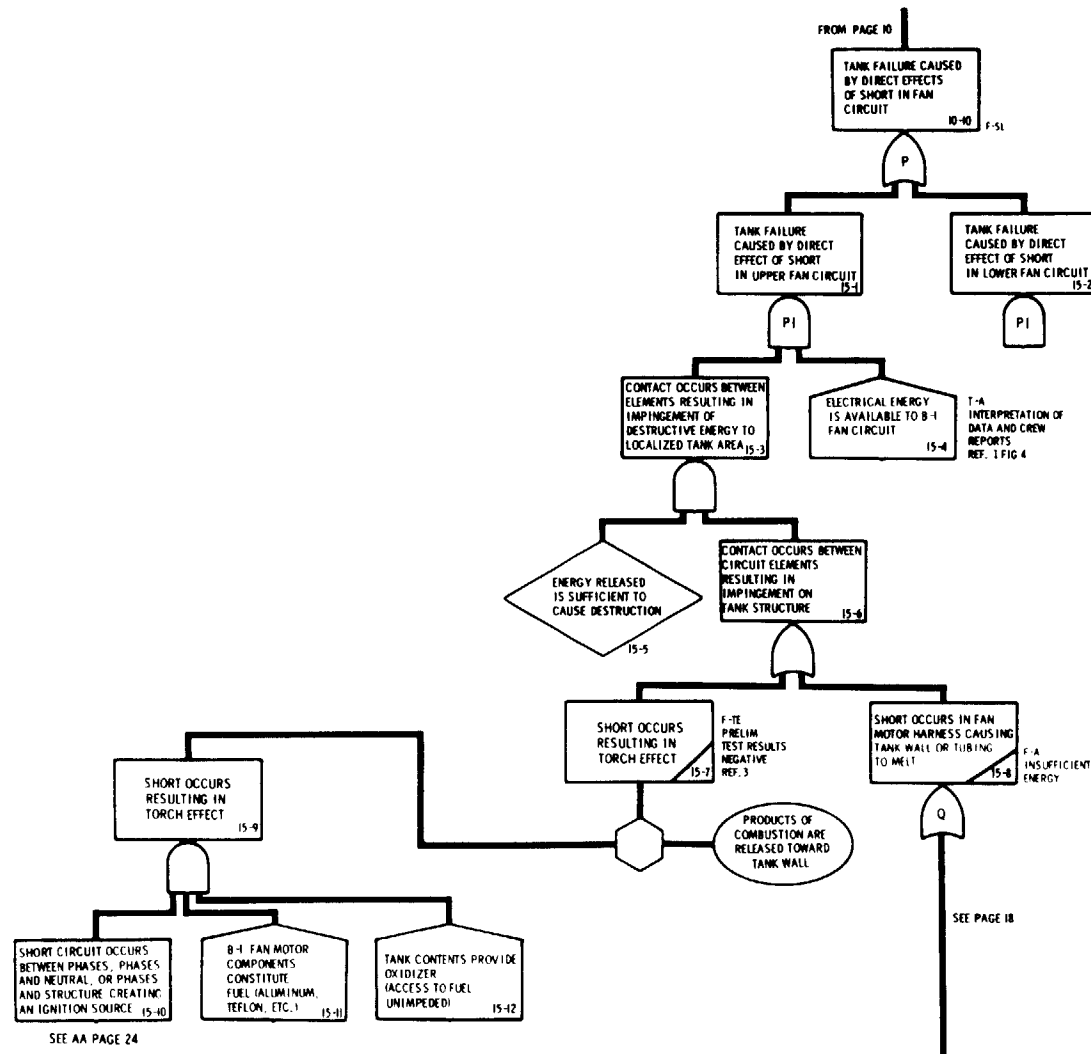

F-131

O₂ IN VACUUM CAVITY
PAGE 16

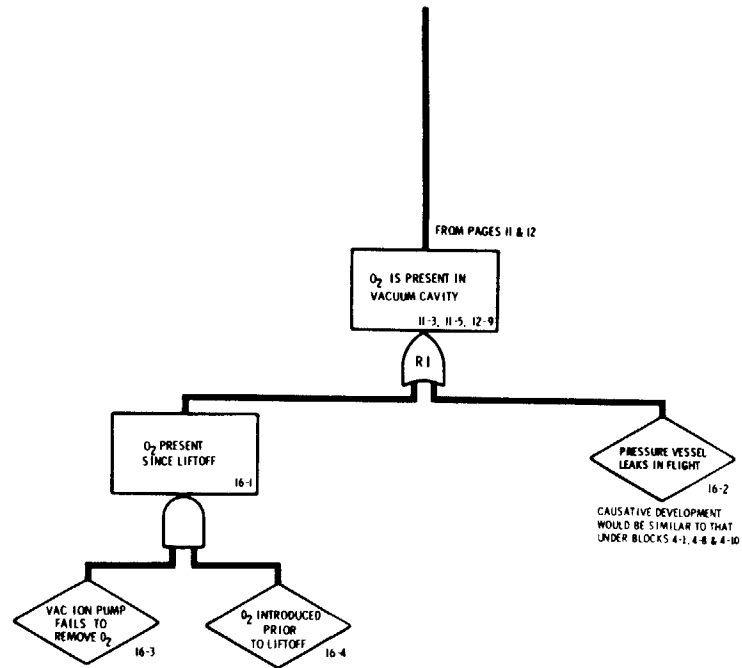

O₂ IN VACUUM CAVITY
PAGE 16

F-132

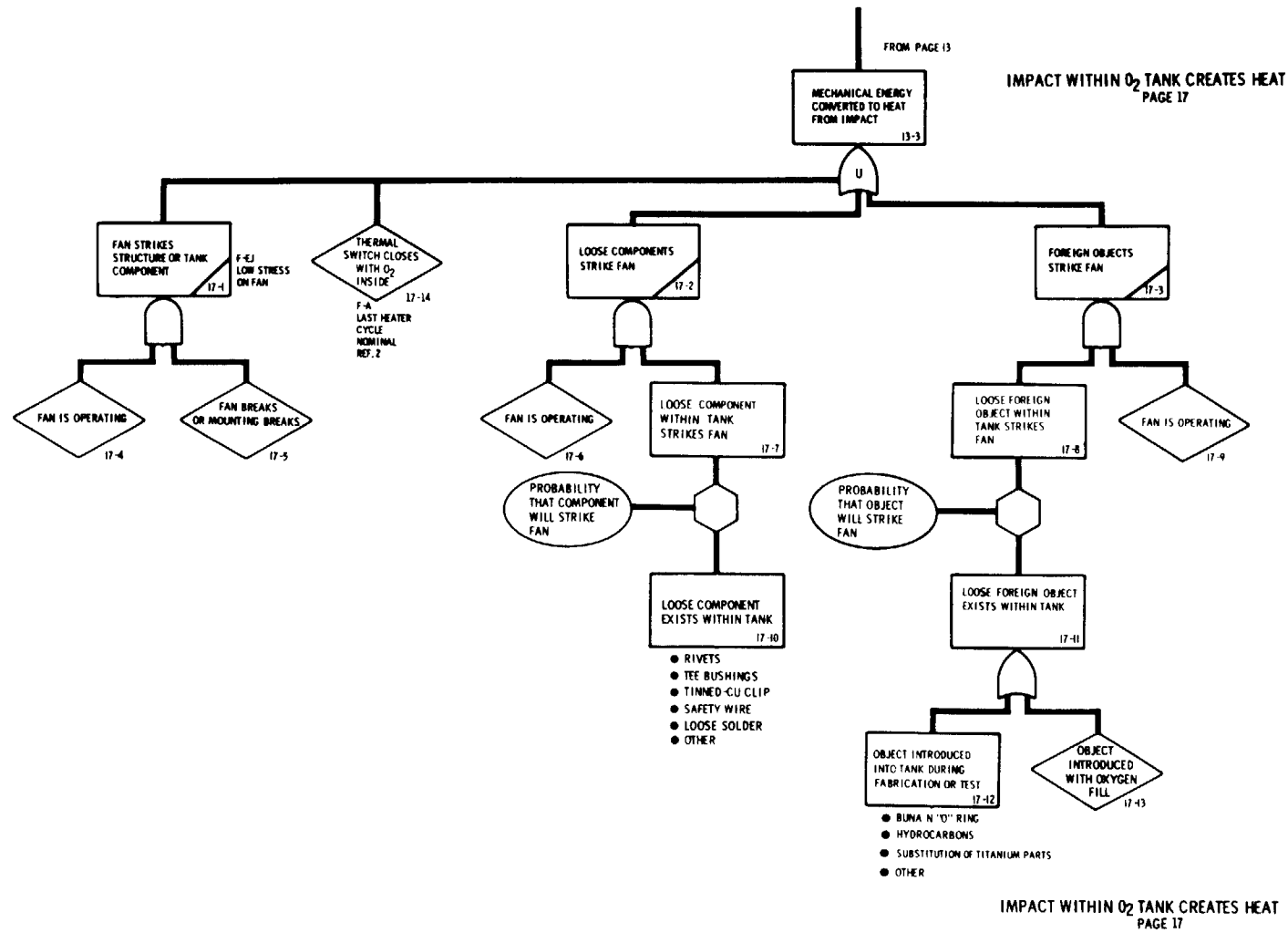

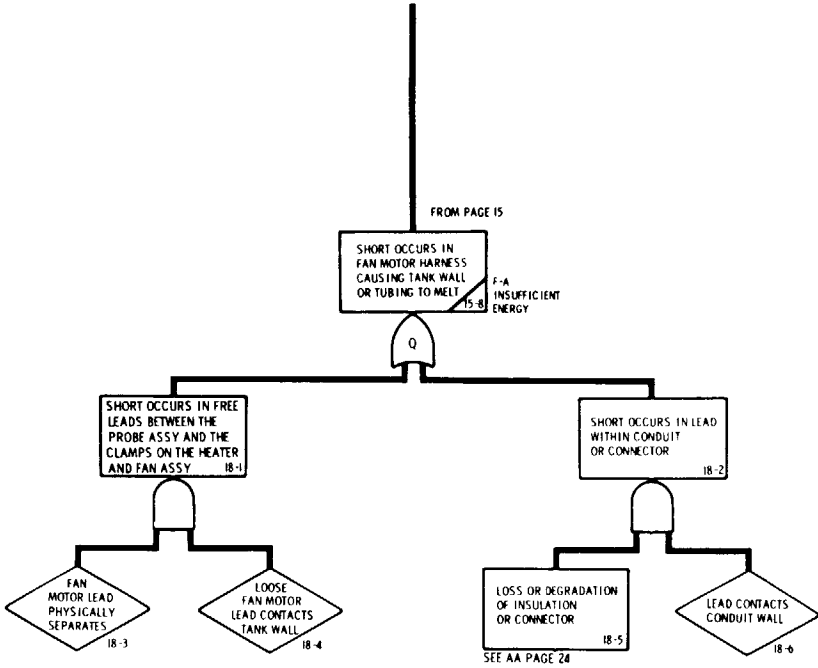

F-133

F-134

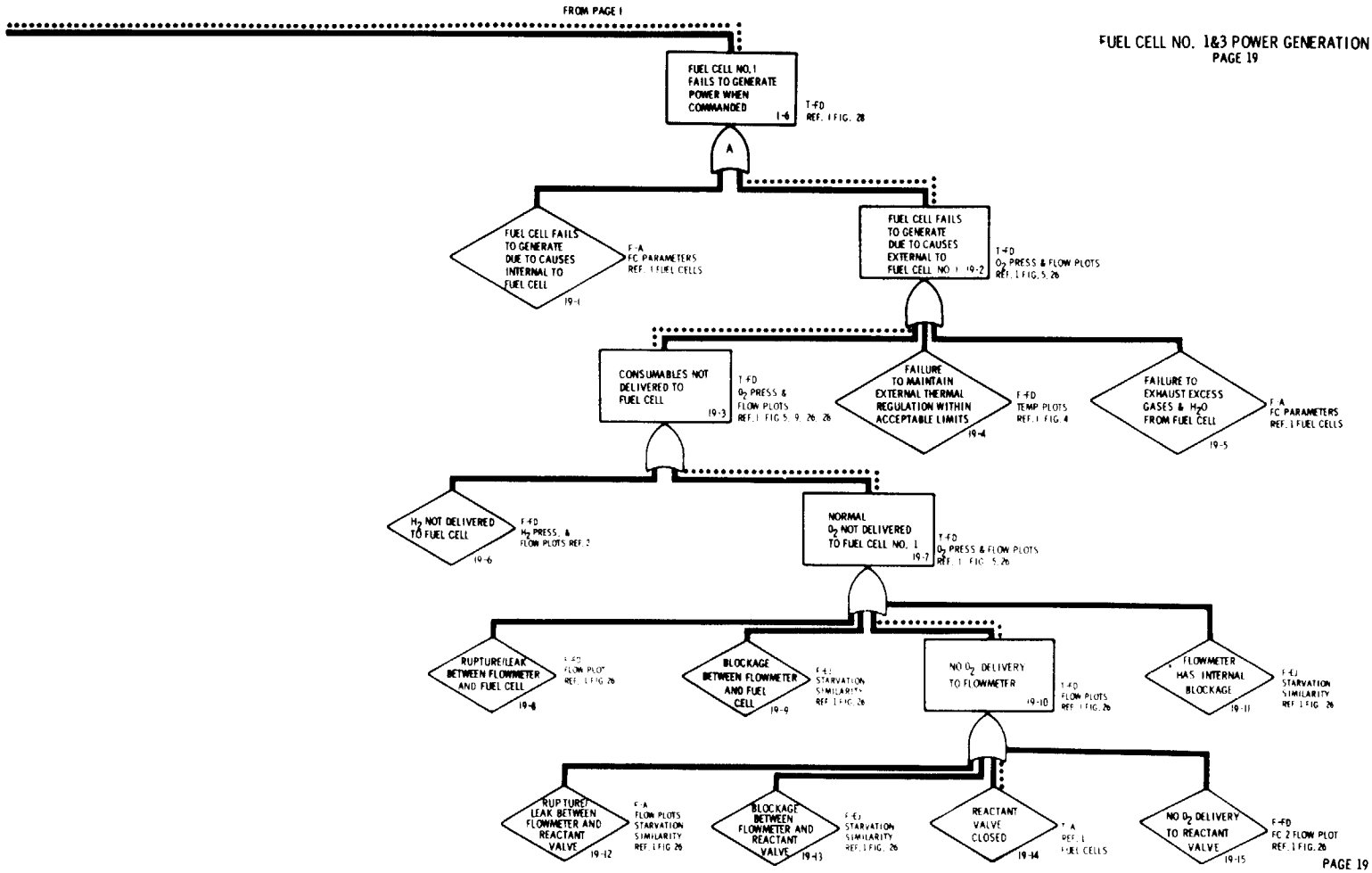

F-135

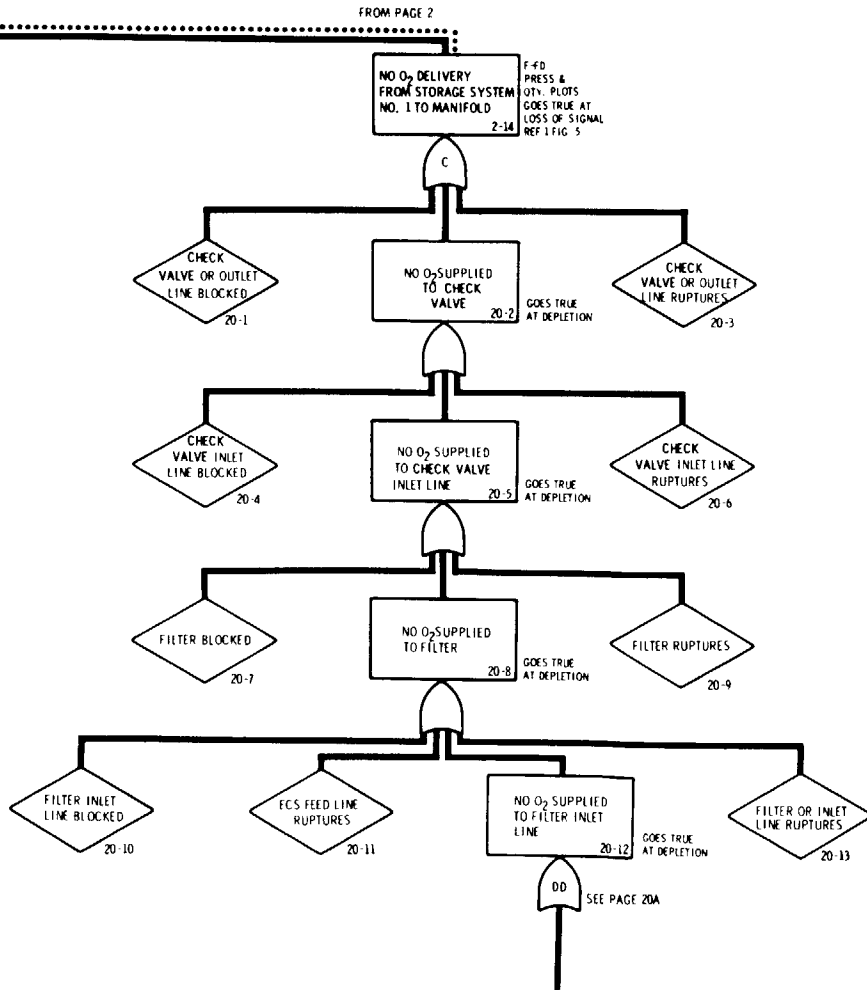

F-136

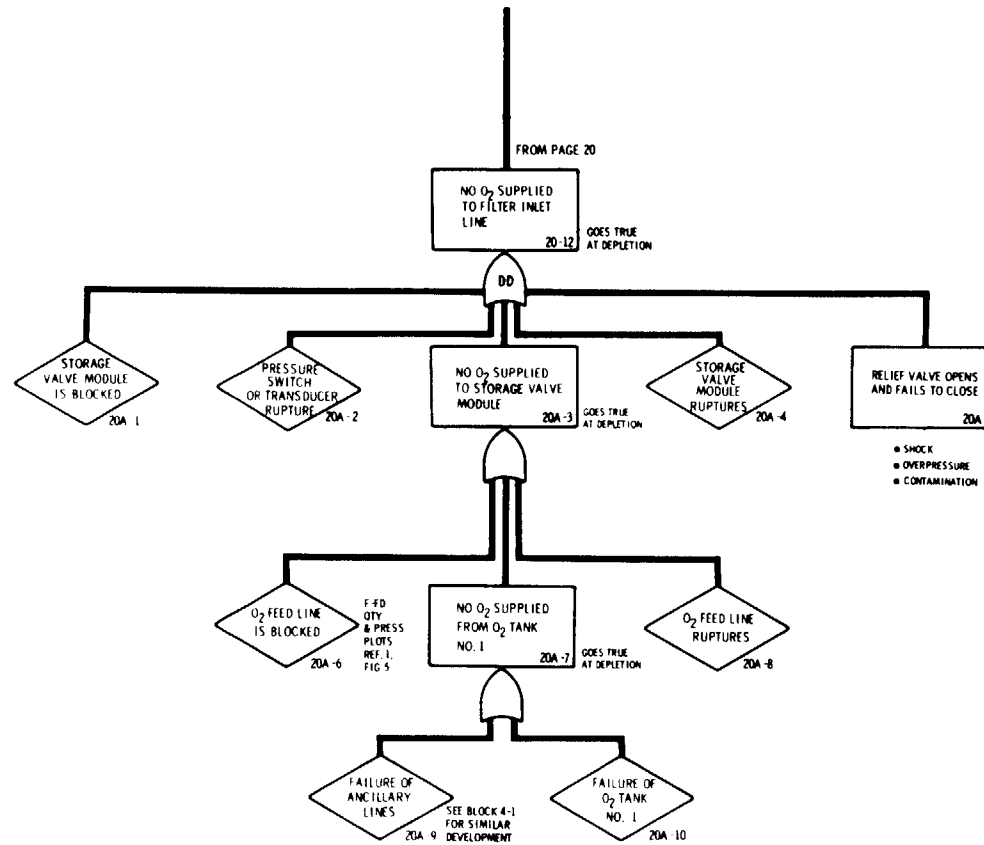

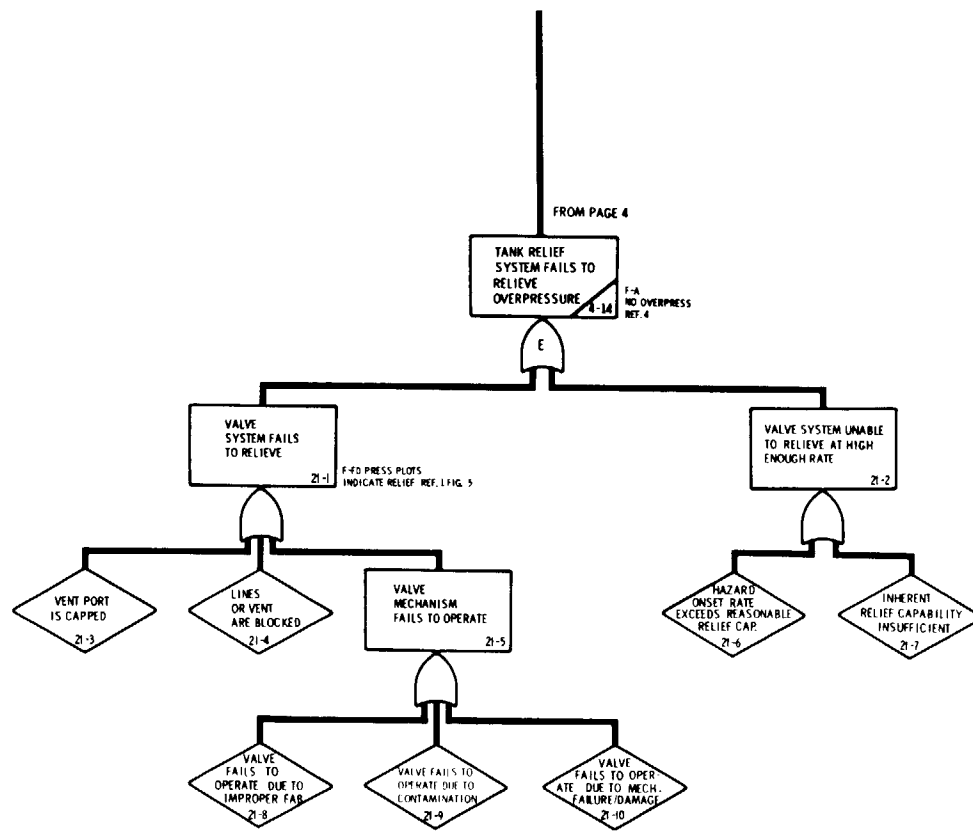

F-137

F-138

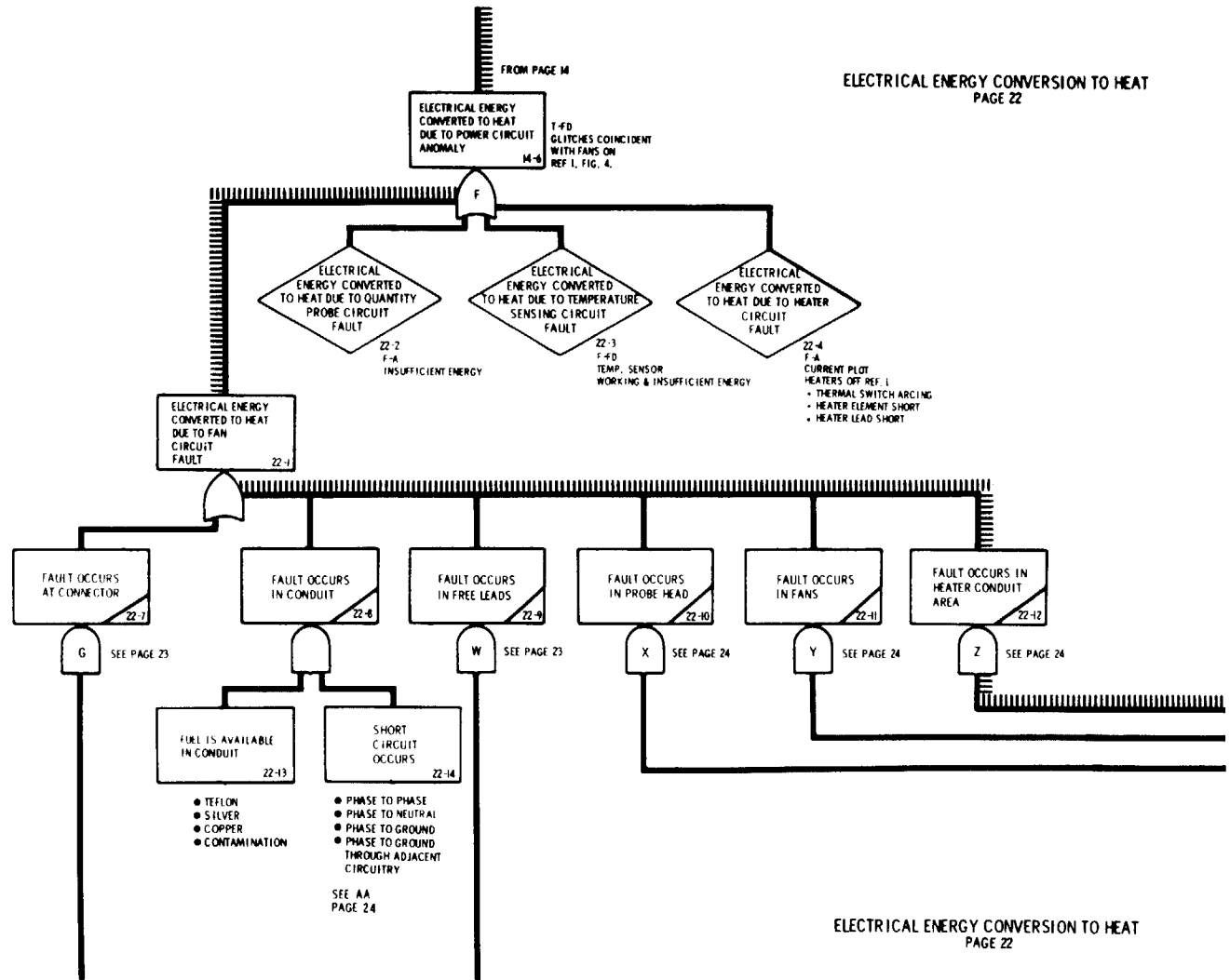

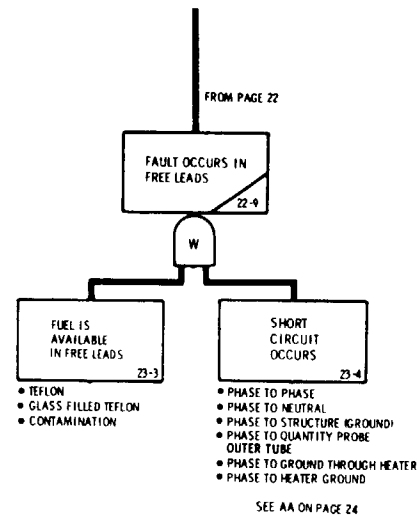
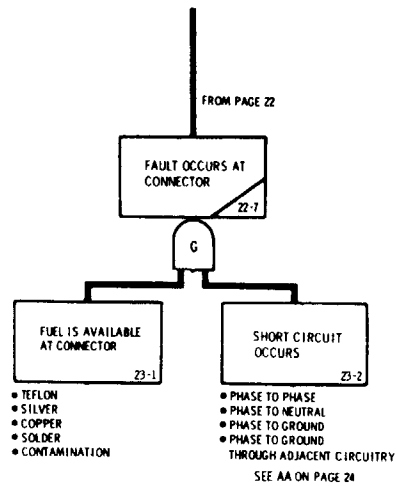

FT-140

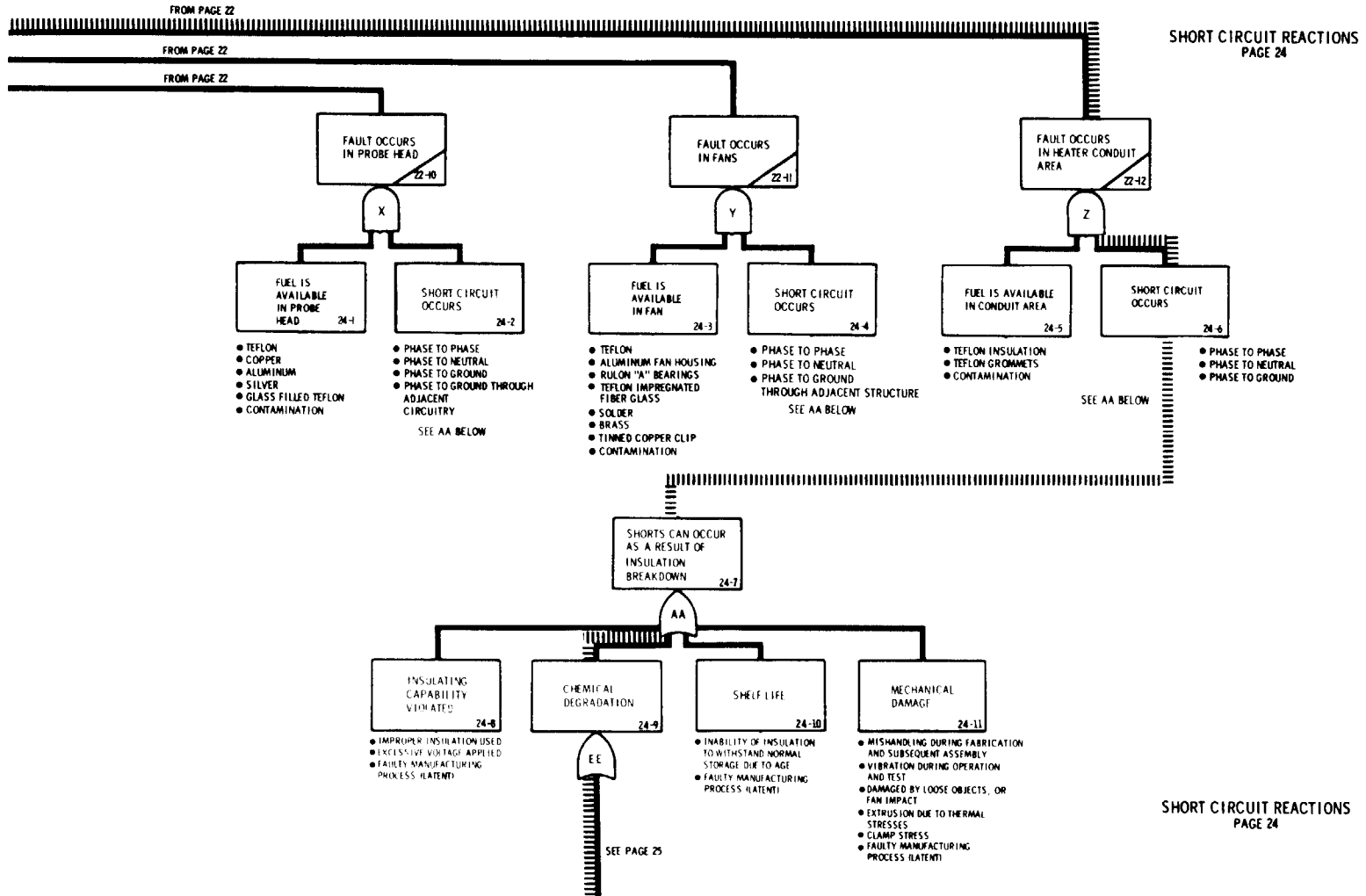

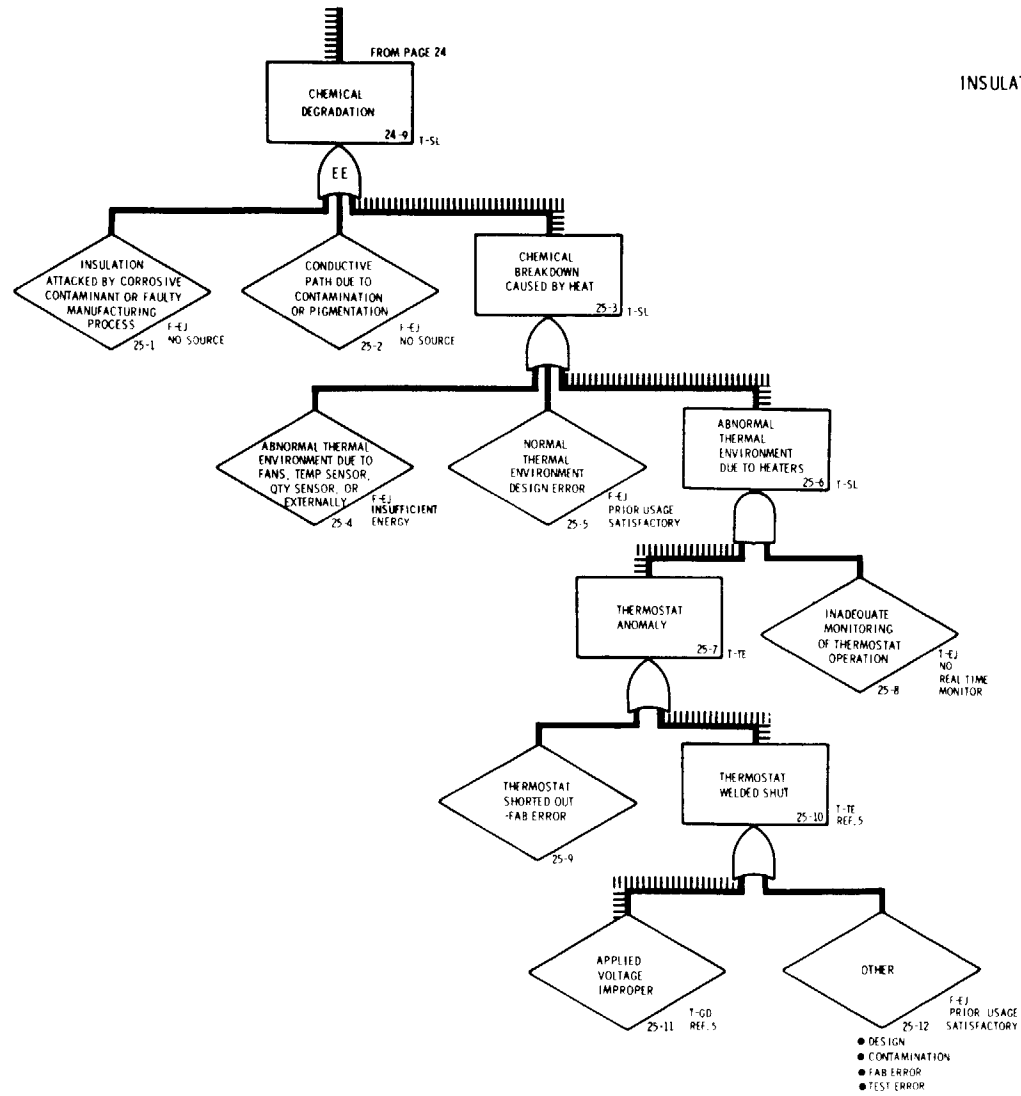

E-141

REFERENCES

1. Weber, Laurence A.: Thermodynamic and Related Properties of Oxygen from the Triple Point to 300° K at Pressures to 330 Atmospheres. Supplement A (British Units), NBS Report 9710A, August 29, 1968.
2. Stewart, Richard B.: The Thermodynamic Properties of Oxygen. PH.D. Thesis, Dept. of Mechanical Engineering, University of Iowa, June 1966.
3. Weber, Laurence A.: P-V-T, Thermodynamic and Related Properties of Oxygen from the Triple Point to 300 K at Pressures to 33 MN/m². Journal of Research of the National Bureau of Standards - A. Physics and Chemistry, Vol. 74A, No. 1, January-February 1970, pp. 93-129.

APPENDIX G

BOARD ADMINISTRATIVE PROCEDURES

INDEX OF ADMINISTRATIVE PROCEDURES

<u>Number</u>	<u>Title</u>	<u>Date</u>
1.	Authority to Act for the Chairman of the Apollo 13 Review Board	April 24, 1970
2.	Official File of the Apollo 13 Review Board	April 24, 1970
3.	Response to Offers of Assistance or Recommendation	April 24, 1970
4.	Apollo 13 Review Organization and Structure	April 24, 1970
5.	Overview Responsibilities Assigned to Apollo 13 Review Board Members	April 24, 1970
6.	Designation of Apollo 13 Review Board Panel Chairmen and General Responsibilities	April 24, 1970
7.	Use of Consultants, Advisors, and other Special Assistants to the Apollo 13 Review Board	April 24, 1970
8.	Requisition and Control of Data and Equipment Related to the Apollo 13 Review Board Activities	April 24, 1970
9.	General Assignments to Apollo 13 Review Board Supporting Offices	April 24, 1970
10.	Apollo 13 Review Board Sessions	April 24, 1970
11.	Work Orders	April 27, 1970
12.	Interrelationship of Activities of the Apollo 13 Review Board with Those of the MSC Apollo 13 Investigation Team	April 27, 1970
13.	Records of the Proceedings of the Executive and General Sessions of the Board	May 1, 1970
14.	Coordination and Control of Test Support for Apollo 13 Review Board	May 6, 1970
15.	Custody of and access to Apollo 13 Review Board Materials	May 22, 1970

This page left blank intentionally.

April 24, 1970

APOLLO 13 REVIEW BOARD

ADMINISTRATIVE PROCEDURE NO.1

TITLE: Authority to act for the Chairman of the Apollo 13 Review Board.

POLICY: 1. The Chairman of the Apollo 13 Review Board will designate a member of the Board to act for him during his absence from MSC.

2. The authority delegated to the Acting Chairman is full and complete and includes all the authorities vested in the Chairman by virtue of the NASA Administrator's letter of April 17, 1970.

PROCEDURES: Delegation of authority to act for the Chairman in his absence from MSC will be prepared by the Secretariat.



Edgar M. Cortright

April 24, 1970

APCLLO 13 REVIEW BOARD

ADMINISTRATIVE PROCEDURE NO. 2

- TITLE: Official File of the Apollo 13 Review Board.
- SCOPE: This procedure covers the accumulation and preservation of all documents required for the official Apollo 13 Review Board file including documents acquired and maintained by Panels and supporting offices.
- POLICY: The documentation of actions taken by the Board and Panels is required by the Board's Charter. The orderly organization of the documentation is essential for the preparation of the Board's Report to the Administrator.
- PROCEDURES:
1. All documents received by the Board or emanating from the Chairman or Members of the Board will be maintained by the Secretariat.
 2. All documents received by Panels or Sub-Panels will be maintained by these organizations until incorporation into the Board's files at the time Panel Reports are accepted by the Board.
 3. Support offices of the Board will maintain all documents pertinent to their areas of responsibility.
 4. Documents intended for incorporation in the Panel and Board's Reports will be identified as such by Panel Chairmen and the Board, as appropriate.
 5. Documents referenced in the Panel and Board's Reports will be identified as such, and classified in a manner that will permit quick retrieval.
- DEFINITION:
1. "Documents" means any form of communication (written, recorded, or photographic).



Edgar M. Cortright

April 24, 1970

APOLLO 13 REVIEW BOARD

ADMINISTRATIVE PROCEDURE NO. 3

- TITLE: Response to Offers of Assistance or Recommendation
- POLICY: Offers of assistance or recommendation addressed to the Apollo 13 Review Board (Chairman, individual members, or any Board participant) will be answered by a member of the Apollo 13 Review Board or by individuals designated by the Chairman of the Board.
- PROCEDURE:
1. All messages (letters, telegrams, or other written communications) addressed to the Apollo 13 Review Board or to any of its participants which are identified as suggestions or offers of help or assistance will be forwarded to the Public Affairs Office of the Apollo 13 Review Board.
 2. The Public Affairs Office will arrange for the preparation of replies to all such messages.
 3. Copies of all incoming and outgoing correspondence or offers of assistance will be maintained for the Board by the Public Affairs Office.
 4. The Head of the Apollo 13 Review Board Public Affairs Office is authorized to acknowledge all messages of assistance covered by this Procedure, and to reply to messages in the name of the Chairman of the Apollo 13 Review Board.



Edgar M. Cortright

April 24, 1970

APOLLO 13 REVIEW BOARD

ADMINISTRATIVE PROCEDURE NO. 4

- TITLE: Apollo 13 Review Board Organization and Structure.
- SCOPE: This document establishes the basic organization and responsibilities of the Apollo 13 Review Board. This procedure is an implementation of the Administrator's memorandum of April 21, 1970.
- POLICY: 1. The Apollo 13 Review Board was established by the Administrator, NASA, on April 17, 1970, pursuant to NASA Management Instruction 8621.1, dated April 14, 1966. The following responsibilities and duties were assigned to the Board:
- a. Review the circumstances surrounding the accident to the spacecraft which occurred during the flight of Apollo 13, and the subsequent flight and ground actions taken to recovery, in order to establish the probable cause or causes of the accident and assess the effectiveness of the recovery actions.
 - b. Review all factors relating to the accident and recovery actions the Board determines to be significant and relevant, including studies, findings, recommendations, and other actions that have been or may be undertaken by the program offices, field centers, and contractors involved.
 - c. Direct such further specific investigations as may be necessary.
 - d. Report as soon as possible its findings relating to the cause or causes of the accident, and the effectiveness of the flight and ground recovery actions.
 - e. Develop recommendations for corrective or other actions, based upon its findings and determinations or conclusions derived therefrom.

f. Document its findings, determinations, and recommendations, and submit a final report.

2. The membership of the Apollo 13 Review Board has been established by the Administrator in letters to individual Board members, as follows:

	<u>Members</u>	<u>Date of Appointment</u>
a.	Mr. Edgar M. Cortright Director, Langley Research Center, Chairman of the Apollo 13 Review Board	April 17, 1970
b.	Mr. Robert F. Allnutt Assistant to the Administrator, NASA Headquarters, Member	April 21, 1970
c.	Mr. Neil A. Armstrong Astronaut, Manned Spacecraft Center, Member	April 21, 1970
d.	Dr. John F. Clark Director, Goddard Space Flight Center, Member	April 21, 1970
e.	Brig. Gen. Walter R. Hedrick, Jr. Office of Deputy Chief of Staff, Research and Space Headquarters, USAF	April 21, 1970
f.	Mr. Vincent L. Johnson Deputy Associate Administrator (Engineering), Office of Space Sciences and Applications, NASA Headquarters, Member	April 21, 1970
g.	Mr. Milton Klein Manager, AEC-NASA Space Nuclear Propulsion Office, Member	April 21, 1970
h.	Dr. Hans M. Mark Director, Ames Research Center, Member	April 21, 1970

3. Technical support to the Board:

Mr. Charles W. Mathews April 21, 1970
Deputy Associate Administrator,
Office of Manned Space Flight,
NASA Headquarters

4. Counsel to the Board has been appointed by the Administrator:

Mr. George T. Malley April 21, 1970
Chief Counsel, Langley Research Center

5. Observers to the Apollo 13 Review Board have been appointed by the Administrator, NASA, as follows:

	<u>Members</u>	<u>Date of Appointment</u>
a.	Mr. William A. Anders Executive Secretary, National Aeronautics and Space Council	April 21, 1970
b.	Dr. Charles D. Harrington Chairman, NASA Aerospace Safety Advisory Panel	April 21, 1970
c.	Mr. I. Irving Pinkel Director, Aerospace Safety Research and Data Institute	April 21, 1970
d.	Mr. James E. Wilson Technical Consultant to the Committee on Science and Astronautics U.S. House of Representatives	April 22, 1970

6. Heads of Apollo 13 Review Board Supporting Offices have been appointed by the Chairman of the Apollo 13 Review Board. These officials are:

- a. Secretariat - Mr. Ernest P. Swieda, KSC
- b. Public Affairs - Mr. Brian Duff, MSC
- c. Legislative Affairs - Mr. Gerald J. Mossinghoff,
NASA Headquarters
- d. Report Editorial Group - Mr. R. G. Romatowski, LRC

PROCEDURES: 1. The following organization of the Apollo Review Board is established:

a. Panels

- (1) Mission Events
- (2) Manufacturing and Test
- (3) Design
- (4) Project Management

b. Board Offices

- (1) Public Affairs
- (2) Report Editorial Office
- (3) Legislative Affairs
- (4) Secretariat

2. In addition to the Board organization established by the Chairman, the Administrator, NASA, has established a number of observers to the Board. Each observer shall have a direct access to the Board Chairman.

3. Sub-panel structure and assignment of responsibilities will be authorized by the Chairman.

4. Changes to the basic organization of the Apollo 13 Review Board may only be authorized by the Chairman. All such changes will be officially implemented in documentation prepared by the Secretariat.



Edgar M. Cortright

April 24, 1970

APOLLO 13 REVIEW BOARD

ADMINISTRATIVE PROCEDURE NO. 5

- TITLE: Overview responsibilities assigned to Apollo 13 Review Board Members.
- SCOPE: This document establishes overview responsibilities assigned to members of the Apollo 13 Review Board.
- POLICY: Assignment of overall responsibilities to members of the Apollo 13 Review Board will be made by the Chairman. Specific assignments may be made in memorandum form signed by the Chairman. Any specific assignments will be made part of the official records of the Apollo 13 Review Board.
- PROCEDURES: 1. Overview assignments to members of the Apollo 13 Review Board are established as follows:

<u>Member of the Board</u>	<u>Overview Assignment</u>
Neil Armstrong, MSC	Mission Events
Dr. John Clark, GSFC	Manufacturing and Test
V. L. Johnson, OSSA	Design
M. Klein, SNPO	Project Management
Brig. Gen. Hedrick, USAF	Apollo 13 Panel Integration
Dr. Hans Mark, ARC	Special Studies and Coordination of Expert Advice and Assistance
R. F. Allnutt, NASA Hqs	Report Editing and Board Documentation

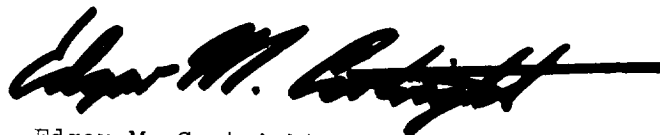

Edgar M. Cortright

April 24, 1970

APOLLO 13 REVIEW BOARD

ADMINISTRATIVE PROCEDURE NO. 6

TITLE: Designation of Apollo 13 Review Board Panel Chairmen and general responsibilities.

SCOPE: This document establishes the general assignments made to the Chairmen of Apollo 13 Review Board Panels.

POLICY: The assignment of tasks and responsibilities to Panel Chairmen will be made by the Chairman of the Apollo 13 Review Board. Each Panel Chairman will draw upon the data, analyses, and technical expertise of the staff at MSC and the Apollo contractors. In addition, sufficient independent checks and analyses will be made to constitute a clear and sufficient validation of key findings.

PROCEDURES: 1. The following Panel Chairmen are designated:

<u>Panel</u>	<u>Chairman</u>
a. Mission Events	F. B. Smith, NASA Hqs.
b. Manufacturing and Test	H. M. Schurmeier, JPL
c. Design	S. Himmel, LeRC
d. Project Management	E. Kilgore, LRC

2. Panel Chairmen are the Board's principal reviewing agents for specified areas of the Apollo 13 Mission. General responsibilities of Panel Chairmen include:

a. Maintaining a day-by-day record of activities including such information as:

- (1) Meetings
- (2) Subject matter
- (3) Attendance
- (4) Minutes (when appropriate)

b. Collecting and retaining for the Board all records, tapes, photographs, studies and other documents which

may be needed to substantiate Board findings and determinations within a Panel area of inquiry.

c. Preparation of preliminary findings and determinations for evaluation and assessment by the Board.

3. General area assignments for each Panel Chairman are appended to this procedure. These may not be changed without the approval of the Apollo 13 Review Board Chairman.
4. Each Panel Chairman will coordinate his reviews, analyses, and findings with the other Panels as appropriate.
5. Each Panel Chairman will work under the overall guidance and direction of a Board Member designated by the Board Chairman. (See Procedure No. 5)
6. Each Panel Chairman is responsible for designating an alternate in case of temporary absence. This alternate must be approved by the Board Member assigned to overview Panel activities.
7. Each Panel Chairman is responsible for recommending membership on the panel. Such memberships must be approved by the Chairman of the Apollo 13 Review Board.
8. Specific Task Assignments made to Panel Chairmen by the Board Chairman will be cataloged and maintained by the Secretariat.
9. Panel reports of findings, determinations, and recommendations (together with complete supporting documentation) will be required of all Panels. Any minority positions relative to Panel Reports will be brought to the attention of the Board.



Edgar M. Cortright

General Assignment for Mission Events Panel

It shall be the task of the Mission Events Panel to provide a detailed and accurate chronology of all pertinent events and actions leading to, during, and subsequent to the Apollo 13 incident. This information, in narrative and graphical time-history form, will provide the Apollo 13 Review Board an official events record on which their analyses and conclusions may be based. This record will be published in a form suitable for inclusion in the Review Board's official report.

The Panel will report all significant events derived from telemetry records, air-to-ground communications transcripts, crew and control center observations, and appropriate documents such as the flight plan, mission technique description, Apollo Operations Handbook, and crew checklists. Correlation between various events and other observations related to the failure will be noted. Where telemetry data are referenced, the Panel will comment as appropriate on their significance, reliability, accuracy, and on spacecraft conditions which might have generated the data.

The chronology will consist of three major sections: Preincident Events; Incident Events; and Postincident Events. The decision-making process leading to the safe recovery, referencing the relevant contingency plans and available alternates, will be included.

Preincident Events. This section will chronicle the progress of the flight from the countdown to the time of the incident. All action and data relevant to the subsequent incident will be included.

Incident Events. This section will cover that period of time beginning at 55 hours and 52 minutes after lift-off and continuing so long as abnormal system behavior is relevant to the failure.

Postincident Events. This section will document the events and activities subsequent to the incident and continuing to mission termination (Splash). Emphasis will be placed on the rationale used on mission completion strategy.

General Assignment for Manufacturing and Test Panel

Review the manufacturing and testing, including the associated reliability and quality assurance activities, of the flight hardware components involved in the flight failure as determined from the review of the flight data and the analysis of the design. The purpose of this review is to ascertain the adequacy of the manufacturing procedures, including any modification, and the preflight test and checkout program and any possible correlation of these activities with the inflight events.

The Panel shall consist of three activities:

1. Fabrication and Acceptance Testing

This will consist of reviewing the fabrication, assembly, and acceptance testing steps actually used during the manufacturing of the specific flight hardware elements involved. Fabrication, assembly, and acceptance testing procedures and records will be reviewed, as well as observation of actual operations when appropriate.

2. Subsystem and System Testing

This will consist of reviewing all the flight qualification testing from the completion of the component level acceptance testing up through the countdown to lift-off for the specific hardware involved. Test procedures and results will be reviewed, as well as observing specific tests where appropriate. Results of tests on other serial no. units will also be reviewed when appropriate.

3. Reliability and Quality Assurance

This will be an overview of both the manufacturing and testing, covering such things as parts and material qualification and control, assembly and testing procedures, and inspection and problem/failure reporting and closeout.

General Assignment for Design Panel

The Design Panel shall examine the design of the oxygen and associated systems to the extent necessary to support the theory of failure. After such review the Panel shall indicate a course of corrective action which shall include requirements for further investigations and/or redesign. In addition, the panel shall establish requirements for review of other Apollo spacecraft systems of similar design.

The Panel shall consist of four subdivisions:

1. Design Evaluation

This activity shall review the requirements and specifications governing the design of the systems, subsystems, and components, their derivation, changes thereto and the reasons therefor, and the design of the system in response to the requirements, including such elements as design approach, material selection, and stress analysis; and development and qualification test programs and results. This activity shall also review and evaluate proposed design modifications, including changes in operating procedures required by such modifications.

2. Failure Modes and Mechanisms

This activity shall review the design of the systems to ascertain the possible sources of failure and the manner in which failure may occur. In this process, they shall attempt to correlate such modes with the evidence from flight and ground test data. This shall include considerations such as energy sources, materials compatibility, nature of pressure vessel failure, effects of environment and service, the service history of any suspect systems and components, and any degradation that may have occurred.

3. Electrical

This activity shall review the design of all electrical components associated with the theory of failure to ascertain their adequacy. This activity shall also review and evaluate proposed design modifications, including changes in operating procedures required by such modifications.

4. Related Systems

This activity shall review the design of all systems similar to that involved in the Apollo 13 incident with the view to establishing any commonality of design that may indicate a need for redesign. They shall also consider the possibility of design modifications to permit damage containment in the event of a failure.

General Assignment for Project Management Panel

The Project Management Panel will undertake the following tasks:

1. Review and assess the effectiveness of the management structure employed in Apollo 13 in all areas pertinent to the Apollo 13 incident. This review will encompass the organization, the responsibilities of the organizational elements, and the adequacy of the staffing.

2. Review and assess the effectiveness of the management systems employed on Apollo 13 in all areas pertinent to the Apollo 13 incident. This task will include the management systems employed to control the appropriate design, manufacturing, and test operations; the processes used to assure adequate communications between organizational elements; the processes used to control hardware and functional interfaces; the safety processes involved; and protective security.

3. Review the project management lessons learned from the Apollo 13 mission from the standpoint of their applicability to subsequent Apollo missions.

Tasks (1) and (2), above, should encompass both the general review of the processes used in Apollo 13, and specific applicability to the possible cause or causes of the mission incident as identified by the Board.

April 24, 1970

APOLLO 13 REVIEW BOARD

ADMINISTRATIVE PROCEDURE NO. 7

TITLE: Use of Consultants, Advisors, and other special assistants to the Apollo 13 Review Board.

POLICY: This procedure provides for the utilization of consultants and advisors to the Apollo 13 Review Board.

PROCEDURES: 1. All official advisors and consultants to the Apollo 13 Review Board will be appointed by the Chairman of the Board.

2. Advisors and consultants will be given task assignments whenever practicable so as to focus their efforts on behalf of the Board.

3. Whenever appropriate, experts and consultants utilized by the Board will submit their advice or opinions in writing and these documents will become part of the Board's official file.



Edgar M. Cortright

April 24, 1970

APOLLO 13 REVIEW BOARD

ADMINISTRATIVE PROCEDURE NO. 8

TITLE: Requisition and Control of Data and Equipment Related to the Apollo 13 Review Board Activities.

POLICY: The Chairman of the Apollo 13 Review Board has been authorized by the Administrator to impose controls on the use of Apollo data and/or equipment when such constraints are deemed necessary for the conduct of the Board review. Such acquisition and control may only be authorized by a Member of the Board acting for the Chairman. Whenever the sequestration of data or equipment may delay or hinder program needs, the control will be for a minimum of time adequate for the needs of the Board.

PROCEDURES:

1. Data and/or equipment required by a Panel or the Board will be identified in a Data Control Request approved by the Chairman or Member of the Apollo 13 Review Board.
2. The Data Control Request will be submitted to the program organization through the MSC Apollo Office. The MSF Technical Representative to the Apollo 13 Review Board will transmit all such requests on behalf of the Board.
3. Each Data Control Request will be logged by the Secretariat and closed out at the earliest appropriate time. All such requests, MSF acknowledgements, and subsequent closeouts will be part of the official files of the Board.

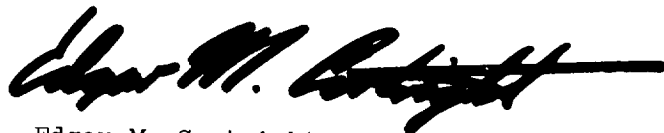

Edgar M. Cortright

April 24, 1970

APOLLO 13 REVIEW BOARD

ADMINISTRATIVE PROCEDURE NO. 9

TITLE: General Assignments to Apollo 13 Review Board Supporting Offices.

PROCEDURES: 1. The Heads of Apollo 13 Review Board supporting offices were established in Administrative Procedure No. 4, dated April 24, 1970.

2. General assignments of responsibility to the Heads of these offices are attached to this document. Changes may be made only with the approval of the Apollo 13 Review Board Chairman.

A handwritten signature in black ink, appearing to read "Edgar M. Cortright", with a long horizontal flourish extending to the right.

Edgar M. Cortright

April 24, 1970

ATTACHMENT A — SECRETARIAT

The Secretariat of the Apollo 13 Review Board will:

1. Provide for complete administrative support to the Board, including clerical assistance, office space, supplies, equipment, transportation, travel, housing arrangements, and other logistic and administrative support.
2. Maintain all official files, minutes, and other Board documentation and correspondence.
3. Coordinate Board Schedules and plans so as to maximize the most efficient utilization of time and effort.
4. Act as the liaison point with MSC and other Center officials on all administrative matters.

April 24, 1970

ATTACHMENT B — REPORT EDITORIAL OFFICE

The Head of the Report Editorial Office will:

1. Recommend to the Board the form and content of the Board's Report to the Administrator.
2. Organize the report, supervise its preparation, and provide for the complete review of all preliminary and final drafts.
3. Insure that Counsel to the Board is consulted on all report material with respect to legal sufficiency and substance.

April 24, 1970

ATTACHMENT C — PUBLIC AFFAIRS

The Head of the Apollo 13 Public Affairs Office will:

1. Provide all public affairs support to the Chairman and Members of the Board including preparation, review, and distribution of press releases, statements, and other information releases.
2. Maintain a complete file of all Apollo 13 related press releases and statements made by officials of NASA and supporting agencies which bear on the events and incidents in flight.
3. Maintain biographies, photographs, and other records with respect to Board officials.
4. Provide all liaison with Public Affairs officials in NASA Headquarters, other Centers, and outside agencies.
5. Maintain a complete inventory of letters received from the public which are addressed to the Board Chairman or any Members, including copies of all replies.
6. Report to the Board on a regular basis in order to summarize all significant PAO activities.

April 24, 1970

ATTACHMENT D — LEGISLATIVE AFFAIRS

The Head of the Apollo 13 Legislative Affairs Office will:

1. Provide the Board with complete congressional support, including arranging visits, recommending replies to inquiries, and monitoring a complete record of all congressional activities related to the Board's Charter and responsibilities.

2. Make periodic reports to the Board on the status of congressional activity directly affecting the Board's operations.

April 24, 1970

APOLLO 13 REVIEW BOARD

ADMINISTRATIVE PROCEDURE NO. 10

TITLE: Apollo 13 Review Board Sessions

1. The Apollo 13 Review Board meeting schedules are established, as follows:

a. General Sessions. These will be daily sessions held each evening at a time prescribed by the Chairman of the Apollo 13 Review Board. The purpose of these sessions will be to review the progress of Panel efforts and to establish priorities for further reviews. All participants in the Apollo 13 Review Board organization should attend. Agendas for these meetings will be prepared by the Secretariat after consultation with the Board and the Panel chairmen.

b. Executive Sessions. These will be held at the call of the Chairman (generally each morning). The purpose of these sessions will be to discuss among the Board itself progress and plans for Panel and Support Office activities. Attendance at Executive Sessions will be limited to Members of the Apollo 13 Review Board, and Counsel to the Board, as well as such other members of the Board's organization as are invited by the Chairman. Each Executive Session will be recorded and transcribed.

c. Action items assigned by the Chairman in either the General Session or in Executive Session will be recorded by the Secretariat, and made part of the official files of the Board.



Edgar M. Cortright

April 27, 1970

APOLLO 13 REVIEW BOARD

ADMINISTRATIVE PROCEDURE NO. 11

TITLE: Work Orders

SCOPE: This procedure covers the origination and documentation of Work Orders to the MSC Apollo 13 Investigation Team, hereinafter "Team," and other organizations.

POLICY: All work by other sources connected with the Board's or Panel's investigation will be documented and preserved for the Board's official files.

PROCEDURE: 1. The Panel Chairman, with the concurrence of the cognizant Board member, will originate a Work Order, if the course of the Panel's investigation requires support from outside sources.

2. The Work Order (memorandum form) will include:

A Statement of Work (detailed step-by-step procedures or work items, when appropriate)

Identification of Board, Panel, or other personnel who may visit the work site at the time the work is being performed

Procurement requirements, if known

The kind of data, reports, drawings, and other information required

Period of Performance

Other items essential for a complete understanding of the Work Order

3. The Work Order will be assigned a number by the secretariat and transmitted to the Team.

4. If the Work Order duplicates, in whole or in part, prior work done for the Team, the Team Leader will advise the Panel Chairman to that effect.
5. If the Work Order initiates work not previously performed, in whole or in part, by the Team, the Team Leader will advise the Panel Chairman of the need for amending the Statement of Work to include such work items that are needed by the Team.
6. When coordination between the Team and the Board has been effected, the Team will prepare a Test Preparation Sheet in accordance with its procedures and advise the cognizant Panel Chairman of actions taken, together with periodic reports, when feasible.
7. When the work has been performed the Team Leader will advise the cognizant Panel Chairman and transmit work products, if any, to the Chairman.
8. The Board Secretariat will document close-out actions or final disposition of all Work Order requests.

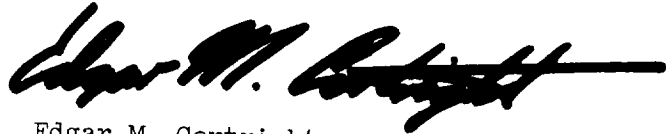
A handwritten signature in black ink, appearing to read "Edgar M. Cortright", with a long horizontal flourish extending to the right.

Edgar M. Cortright

April 27, 1970

APOLLO 13 REVIEW BOARD

ADMINISTRATIVE PROCEDURE NO. 12

TITLE: Interrelationship of activities of the Apollo 13 Review Board with those of the MSC Apollo 13 Investigation Team.

SCOPE: This procedure covers the methodology in conducting a concurrent investigation of the Apollo 13 mission failure.

POLICY: The investigation and review by the Board and the investigation by the Team shall be in accordance with NMI 8621.1, April 14, 1966; and as implemented by the Administrator's memorandum of April 20, 1970 to the Associate Administrator for Manned Space Flight. Further, the Board will conduct its own independent review and conduct such further specific investigations as empowered by the Administrator's memorandum of April 17, 1970: Establishment of Apollo 13 Review Board.

PROCEDURE: 1. Liaison between the Board and the Team is the responsibility of Mr. C. W. Mathews, who provides OMSF technical support to the Board pursuant to the Administrator's memorandum of April 21, 1970.

2. The Board and the Team will establish a working relationship between the Panels of the Board and Team Groups in areas of investigation of mutual interest. Information and data will be freely exchanged between the Panels and the Team Groups.

This information and data, together with information and data obtained independently by the Board Panels, will be analyzed and, when approved by the Board, will be included in interim reports and the final report to the Administrator.

3. All documents published by the Team shall be furnished the Board for its official files.

4. Requests for personnel details of Team members to the Board will be approved by the Chairman and implemented by the OMSF Technical Support representative.

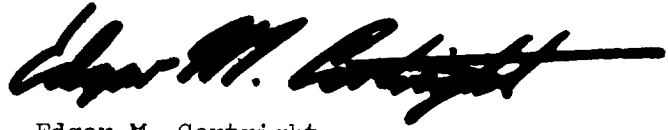
A handwritten signature in black ink, appearing to read "Edgar M. Cortright", with a long horizontal stroke extending to the right.

Edgar M. Cortright

May 1, 1970

APOLLO 13 REVIEW BOARD

ADMINISTRATIVE PROCEDURE NO. 13

- TITLE: Records of the proceedings of the Executive and General Sessions of the Board.
- SCOPE: This procedure covers the methods and responsibilities related to recording the proceedings of the Board during its review and investigation activities.
- POLICY: The proceedings of all the General Sessions of the Board shall be mechanically recorded and placed in transcript form for inclusion in the files of the Board. The Secretariat is responsible for transcribing and initial editing of the record for content and accuracy. Counsel shall be responsible for final review of the transcript. The proceedings of Executive Sessions of the Board shall be mechanically recorded but no transcripts shall be prepared.
- PROCEDURES: 1. The Secretariat shall record all Executive and General Sessions of the Board.
2. The Secretariat shall transcribe the recordings of General Sessions. The Secretariat shall maintain a log and suspense for each transcription during the review process. The rough transcripts shall be edited by the Secretariat for content and accuracy.
3. To the extent feasible, the transcript shall be retyped after the editing and then Counsel shall perform the final review of the transcripts.
4. Following the review, the transcripts of the General Sessions shall be typed in final form and filed by the Secretariat. The tapes for both General and Special Sessions shall be included in the files of the Board by the Secretariat.



Edgar M. Cortright

May 6, 1970

APOLLO 13 REVIEW BOARD

ADMINISTRATIVE PROCEDURE NO. 14

TITLE: Coordination and Control of Test Support for Apollo 13 Review Board.

POLICY: Test support for the Apollo 13 Review Board is to be coordinated within the Board and controlled throughout the tenure of the Board by use of Test Preparation Sheet (TPS).

REFERENCE: 1. Administrative Procedure No. 11, dated April 27, 1970.
2. Memorandum from Donald D. Arabian to Apollo 13 Investigation Team, subject: TPS procedures and requirements, dated May 5, 1970.

PROCEDURES: 1. Whenever any Member, Panel Chairman, or Panel participant requires a test activity by MSC or one of its contractors to support the Board's review of Apollo 13 events, a request should be made in writing using the procedures set forth in the referenced Administrative Procedure.
2. Each such request will be reviewed by a designated Board Member and M&T Panel Chairman before it is submitted to the MSC Team Leader (Simpkinson) for implementation.
3. The designated Board Member and the M&T Panel Chairman will be responsible for maintaining a Master List of Support Tests on which tests will be related to incident events.
4. After coordination within the Board, the support test request (work order) will be submitted to the MSC Team and logged as an official TPS by the Team.
5. Support tests to be carried out by other than MSC or its contractors will also be sent to the M&T Panel Chairman for review and will also be coordinated and logged in as a TPS by the MSC Team. In this case, the intent is to use

the Project's TPS numbering, control, and filing procedures as a central data system for the Review Board and the MSC Investigation Team.

6. The above procedure should be applied to any support test activity initiated by an official member of the Board organization from its inception on April 21, 1970.

A handwritten signature in black ink, appearing to read "Edgar M. Cortright", with a long horizontal flourish extending to the right.

Edgar M. Cortright

May 22, 1970

APOLLO 13 REVIEW BOARD

ADMINISTRATIVE PROCEDURE NO. 15

- TITLE:** Custody of and access to Apollo 13 Review Board Materials
- SCOPE:** This procedure covers the custody of and access to Apollo 13 Review Board materials upon the completion of the Board's activities at the Manned Spacecraft Center (MSC).
- POLICY:** The files and other material used in preparing the Apollo 13 Review Board Report shall be stored in the custody of the Langley Research Center. The files and report materials of the Panels shall be made part of the Review Board files. The files, documentation, and other data of the MSC Investigating Team will not be controlled by the Apollo 13 Review Board. Custody and disposition of the materials preserved by the MSC Team shall be left to MSC Center management. Apollo 13 hardware and original data received from the spacecraft during flight shall be controlled and stored in accordance with the usual MSF procedures.
- PROCEDURE:** Reports, files, tapes, and working materials determined by the Chairman to be included in the final repository shall be in the final custody of the Director, Langley Research Center. Access thereto shall be determined by him or by the Chief Counsel, Langley Research Center.

Adequate secure storage and warehousing will be provided by the Langley Research Center.

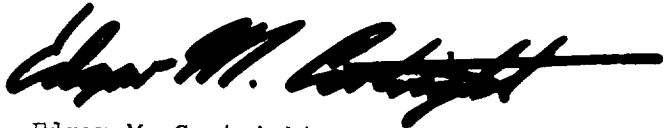

Edgar M. Cortright

NASA — MSC

APPENDIX H

BOARD RELEASES AND PRESS STATEMENTS

CONTENTS

Section	Page
News Release No. A13-10, April 17, 1970	H-1
News Release No. A13-10, April 18, 1970	H-3
Apollo 13 Investigation Board Report No. 1, April 21, 1970 . .	H-4
Apollo 13 Investigation Board Report No. 1, April 24, 1970 . .	H-10
Apollo 13 Press Conference with Dr. George Low, May 1, 1970	H-19
Apollo 13 Review Board Conference, June 2, 1970	H-31
Status Reports of the Apollo 13 Review Board	H-45
Status Report No. 1	H-46
Status Report No. 2	H-47
Status Report No. 3	H-48
Status Report No. 4	H-50
Status Report No. 5	H-51
Status Report No. 6	H-52
Status Report No. 7	H-53
Status Report No. 8	H-54
Status Report No. 9	H-55
Status Report No. 10	H-56
Status Report No. 11	H-57
Status Report No. 12	H-58
Status Report No. 13	H-59
Status Report No. 14	H-60
Status Report No. 15	H-61

This page left blank intentionally.

APOLLO NEWS CENTER
HOUSTON, TEXAS

NEWS RELEASE NO. A13-10
APRIL 17, 1970
SUBJECT: APOLLO 13 REVIEW BOARD

The National Aeronautics and Space Administration today established an Apollo 13 Review Board to investigate the circumstances and causes of the accident aboard the spacecraft Odyssey and the subsequent flight and ground actions taken to recover.

This action was taken by NASA's Administrator, Dr. Thomas O. Paine, and Deputy Administrator, Dr. George M. Low, immediately following the successful recovery of the astronauts today "because of the serious nature of the accident to the Apollo 13 spacecraft which jeopardized human life and caused failure of the Apollo 13 lunar mission."

Mr. Edgar Cortright, Director of NASA's Langley Research Center in Hampton, Virginia, was appointed Chairman of the Review Board. Mr. Cortright served for many years as NASA's Deputy Associate Administrator for Space Science and Applications, and in 1967-68 was Deputy Associate Administrator for Manned Space Flight.

The other members of the Board will be senior individuals from NASA and other government agencies with special competence in flight safety matters, the Apollo systems, or the various technical disciplines related to the investigation, but not having direct responsibilities relating to Apollo 13. Top consultants from government, industry, and the academic community will also be available to the Board as required. NASA's Aerospace Safety Advisory Panel, a statutory panel responsible to the Administrator, will review both the procedures and findings of the Review Board and make an independent report to the Administrator.

The Apollo 13 Review Board will establish its own procedures as provided by standing NASA instructions for the investigation of mission failures. The timing of its report will be determined after the Board has met and made an assessment of the length of investigation required. The Board will make periodic progress reports directly to the Administrator and Deputy Administrator. Timely progress reports will also be made to Congress and the public.

NASA's Office of Manned Space Flight will make available to the Review Board all pertinent records and data and will provide technical support to the Board as requested. The Office of Manned Space Flight,

as a part of its regular responsibilities, will develop parallel recommendations on corrective measures to be taken prior to the Apollo 14 mission.

Decisions on the Apollo 14 mission will depend on the findings and recommendations of the Apollo 13 Review Board, the Aerospace Safety Advisory Panel, and the Office of Manned Space Flight.

APOLLO NEWS CENTER
HOUSTON, TEXAS

NEWS RELEASE NO. A13-10

APRIL 18, 1970

SUBJECT: UP-DATE TO STATUS OF APOLLO 13 REVIEW BOARD

The Chairman of the Apollo 13 Review Board, Mr. Edgar Cortright, Director of NASA's Langley Research Center, expects to discuss with Dr. Paine and Dr. Low on Monday the appointment of additional members of the Board established to review the accident to the Apollo 13 spacecraft. The Board will meet as soon as possible — very soon, Mr. Cortright said — to set up its procedures and begin its investigations.

APOLLO 13 INVESTIGATION BOARD REPORT NO. 1
APRIL 21, 1970

DUFF: Ladies and Gentlemen, this is a briefing by Mr. Edgar M. Cortright, the chairman of the Apollo 13 Review Board. Mr. Cortright.

CORTRIGHT: I thought that it would be beneficial if we got together for a few minutes today to give you some idea of how this Review Board will be conducted, and to announce the members of the Board. The membership has just been selected by Dr. Paine. Basically, as you know, from the material you've received already, and to paraphrase my detailed instructions, the function of the Board is to perform an independent assessment of what happened, why it happened, and what to do about it. To do this, we have selected a group of senior officials from both within the agency and without the agency. These gentlemen will meet here with me during the next few weeks in intensive sessions, which will probably run days, nights, and weekends, without letup, in order to get an early determination. The group will be supported by an additional group of experts, and we will select these gentlemen within the next 2 or 3 days. In addition, we'll draw on the work that the project is now carrying out under the direction of the project manager to determine on their own what happened. Now, the members of the Board are as follows: Mr. Robert Allnutt, who is assistant to the administrator in NASA Headquarters; Mr. Neil Armstrong, astronaut, from the Manned Spacecraft Center; Dr. John Clark, Director of the Goddard Space Flight Center; Brigadier General Walter Hedrick, Jr., Director of Space, Deputy Chief of Staff for R&D office, Headquarters, USAF, Washington; Mr. Vince Johnson, Deputy Associate Administrator for Engineering, in the Office of Space Science and Applications, NASA Headquarters; Mr. Milton Klein, Manager of the AEC-NASA Space Nuclear Propulsion Office; and Dr. Hans Mark, Director of the Ames Research Center.

QUERY: How do you spell that last?

CORTRIGHT: Mark. M-a-r-k. In addition, the counsel, legal counsel, for the Board, will be Mr. George Malley, who is Chief Counsel for the Langley Research Center. Mr. Charles Mathews, Deputy Associate Administrator, Office of Manned Space Flight, will be named to work with the Board to help provide the technical support we'll need to get our job done. In addition, there will be three officially named observers to the

Board. Mr. William Anders, former astronaut, now Executive Secretary, National Aeronautics and Space Council; Dr. Charles D. Harrington, Chairman, NASA Aerospace Safety Advisory Panel, and also President and General Manager of Douglas United Nuclear Incorporated; and Mr. Irving Pinkel, Director, Aerospace Safety Research and Data Institute, Lewis Research Center. We'll be assisted in our relationships with the press by Mr. Brian Duff of the Manned Spacecraft Center. And we'll be assisted in our relationships with the Congress, during the course of this investigation, by Mr. Gerald Mossinghoff, Office of Legislative Affairs, NASA Headquarters. It will be our policy during the course of this investigation to keep you informed of what we're doing, and how we're going about our business, insofar as that is practical. One thing I'd like to avoid, however, is speculation. I must avoid that with this type of a Board. So, if sometimes I appear to be not as communicative as you would like, it will only be because I'm not in a position to say something with authority and certainty, at that time; but otherwise we'll do all we can to keep the members of the press fully informed of what we're doing. And, I think that is about all I really planned to say. I make myself available for questions within the ground rules that I just specified, that I'd like to avoid speculation, and further, since the Board has not held its first meeting, I can't very well represent the Board at this point.

DUFF: I'd just say one thing, before we have questions. The biographies of all the members and the documents relating to what Mr. Cortright has just said will be available after this conference is over. Now we'll take questions.

QUERY: Can I add one point, Brian? I think I forgot to mention that the first meeting of the Board will take place at 8:00 p.m. this evening.

DUFF: All right Bob, we'll start across the front row.

QUERY: I realize it's impossible for you to say precisely how long the Board will take to reach the determination, but do you have any estimate at this time? In other words, would it be a matter of perhaps 3 or 4 weeks or do you think it would last through the summer?

CORTRIGHT: It's my hope that we can reach adequate and effective determination within 3 or 4 weeks. As a matter of fact, that is the number I had in my mind. But we'll have to take as much time as required to do it properly. It could run longer.

SPEAKER Bob.

QUERY: What procedure will you follow for calling perhaps contractor experts and so on? Can you - you said you would talk about them a little bit.

CORTRIGHT: Yes, we identified the need for speciality information that's best developed by a contractor. We'll call on that contractor to provide us information and/or to appear before the Board to testify on this information.

QUERY: Do you have any names or companies already formulated?

CORTRIGHT: No.

QUERY: What is going to be the possibility, Ed, on making your releases? Are you going to do it on a regular basis like once or twice a week, or just whenever you have something to say? How are you going to arrange this?

CORTRIGHT: The releases of the Board will be made only with my approval and through the office of the Public Affairs here at Houston. Now there may, of course, be releases by Dr. Paine or Mr. Low based on information that I can provide them on regular meetings. We'll probably meet once a week. And I would envision the use of bulletins for the press. How much information they would contain would be dependent on how much progress we will make. But at least it would keep you informed on where we are and what activities are facing the Board that week.

QUERY: Do you intend to break the Board down into teams similar to what was done for the 204 Review Board?

CORTRIGHT: That's my current plan. But until the Board meets with me and expresses their individual opinions and negotiate a little bit, I won't know for certain.

DUFF: Here.

QUERY: Ed, when will you have all the telemetry data reduced, do you think, with the Board then in a position to move at full burner?

CORTRIGHT: Well, the telemetry data are being reduced at the moment by a pretty sizable team of engineers, both here and in the contractor's plant. I don't have specifics on that yet, Jules, but I have the impression that they expect some

milestones to be reached before the end of the week, in terms of telemetry data reduction. Of course, that's sort of first time through, perhaps, and we'd have to iterate that to get the last little bit out of it.

QUERY: Was consideration given to appointing Lt. Gen. Sam Phillips to the Board?

SPEAKER: I'm not certain. Dr. Paine selected the Board. I know General Phillips is extremely busy with his present assignment and it probably would be an impossibility.

DUFF: Right here, Mary Bubb.

QUERY: When you finally do pinpoint the cause, sir, how long do you think it will take you to decide whether you have to go into redesign or some modifications? I would presume anyway that you would make recommendations along these lines.

SPEAKER: Well, of course that depends on what the problem is. Generally speaking, you work on potential fixes at the same time you're homing in on the probable cause, so that there need not necessarily be a long period of time between the two, the determination of the problem and what to do about it. On the other hand, there could be under certain circumstances, and my position at the moment is that I can't - I have a totally open mind. I'm trying not to prejudge anything. As the facts unfold, then we'll start forming opinions.

DUFF: Ed.

QUERY: Two questions: I assume that the bulk of the investigation will be conducted here at MSC. Is that correct?

CORTRIGHT: That is correct.

QUERY: And what will the relationship be between your Board's investigation and the investigations already underway by individual contractor teams and by the initial review board that was set up right after the accident? And what is the status of that board, by the way?

CORTRIGHT: Well, I'd rather not comment on the status of the Manned Spacecraft Center Board. That's Dr. Gilruth's board, but I can tell you a little bit about how we plan to work together. In the first place, most of the detailed technical work will have to be done by the men who know that area the

best, and these are the engineers and scientists of the Manned Spacecraft Center and the prime and supporting contractors. We will follow their work and audit their work and make the best possible use of their work that we can. At the same time, we'll maintain sufficient independence so that it will constitute a true independent check on what's done here and an independent assessment of what corrective measures should be taken. Does that answer your question?

QUERY: Mr. Cortright, in your experience have you ever conducted a similar investigation having to do with unmanned spacecraft, trying to find out what happened?

CORTRIGHT: I have not chaired a board of this type, but I've been involved in a number of investigations of various unmanned spacecraft projects, such as Ranger, Surveyor, and Centaur.

QUERY: What was your rate of success in these investigations?

CORTRIGHT: Well, all of the projects that I mentioned succeeded to a rather high degree. The extent to which the review board helped that process is something we'll probably never know.

DUFF: Here in the front row.

QUERY: Will your reports - your periodic reports to Dr. Paine be released to the press?

CORTRIGHT: Probably not.

QUERY: Will we know that there are these reports and will we even know the gist of them, if you're making progress, or stymied, or what?

CORTRIGHT: Well, as I mentioned earlier, we will try to keep the press informed as to what's going on with the Board, but we'll stop short of speculating or prematurely judging the results. That, of course, is quite a constraint in terms of making public what our current opinions are as to what happened, and I think we'll be fairly limited on what we can say until this job is done. Now, my reports to Dr. Paine will be informal progress reports and will contain just the sort of material that it would be improper to release in totality because it's somewhat speculative in nature. I don't think you'd really want that any more than I would.

QUERY: Ed, I'm not quite clear on this point. You may have made it clear and I may have slipped in a cog. Does - is corrective work, such as deemed necessary by various groups here at MSC or the Cape, or wherever else it might be, is corrective work suspended or held in abeyance while the Board meets? For example, if it were found that the liquid oxygen tank, for example, was suffering from stress corrosion or metal fatigue and blew at too low a pressure, and Beech or North American or somebody wanted to go ahead developing new tanks, would that effort go ahead in tandem with the Board's investigation or be held up for the Board's findings?

CORTRIGHT: I'm not positive, but I believe the procedure that would be followed would be that a major corrective work which might impact the existing system and result in changes to hardware that's currently assembled would be held in abeyance until the Board's report was in. On the other hand, it is not unreasonable that certain things could go forward in parallel for possible incorporation later in order to save time now.

QUERY: Dr. Cortright, does your franchise possibly extend to the early shutdown of the second stage engine, and second question, is it likely that you would make any recommendations on the deployment of rescue ships in the Atlantic or even possibly the Indian Ocean?

CORTRIGHT: The instruction does not require us to examine the early shutdown on the second stage engine except insofar as the peak g loads might have influenced the anomaly we're looking into. I don't anticipate that we will be considering deployment or any other aspects of rescue ships.

QUERY: Along the same line, it is in your charter to examine the adequacy of the measures taken in Mission Control to see whether there are some improvements that could be made in those or whether that response could be improved in any way. That is still your understanding?

CORTRIGHT: Yes, sir. That is in the charter, the instructions.

DUFF: Thank you very much.

APOLLO 13 INVESTIGATION BOARD REPORT NO. 1
APRIL 24, 1970

CORTRIGHT: I indicated the other day when we talked that I'd keep you abreast of what we're doing and although I think what I have to say is less than you want to hear, it's a progress report at least. I thought I'd start out by telling you how we've organized to do the job. There was a little indication of that the other day, but this is the structure of the Review Board. This is the Board itself, and I went through those names the other day. Now, in addition, we have four major panels. One is on Mission Events, and this panel is chaired by Frank Smith from NASA Headquarters. In addition, we have asked that Neil Armstrong from the Board have a secondary function of following in depth the activities of this particular panel. The panel will have three members: John Williams from Kennedy Space Center, who will handle preincident events as to the events up to the time of the incident; Tom Ballard, from Langley Research Center, will handle the events of the incident in detail — the short period of time in which the apparent explosion took place; and the postincident events will be handled by Pete Frank, and he is from Houston Manned Spacecraft Center. The second panel is Manufacturing and Test. Schurmeier from the Jet Propulsion Laboratory will handle that, and Jack Clark, the Director of the Goddard Space Flight Center, will be the member of the Board who stays with that panel's activity when he is not meeting with the Board. That panel will also have three members: Ed Baehr from the Lewis Research Center, who will review the fabrication and acceptance testing of the hardware that flew; Karl Heimberg from the Marshall Space Flight Center, who will review the subsystem and system testing of the qualification-type testing; and Brooks Morris from the Jet Propulsion Laboratory, who will look into the reliability and quality assurance aspects of the hardware. The third panel, on Design, will be headed by Mr. Himmel from the Lewis Research Center, and Mr. Johnson of the Board will honcho that activity with him. Now the one member, Dr. Lucas from Marshall, who has been identified to work on failure modes and mechanisms, will also be a design evaluation man and a man to look into related systems, so that if there is a lesson in here to be learned which can be interpreted and applied to other systems it will be his responsibility to understand that. The last panel is on Project Management. Ed Kilgore from Langley Research Center is the Chairman there, and Milt Klein from the Board will work with him. There are three men who will help, a Mr. Ginter from NASA Headquarters,

Mr. Mead from the Ames Research Center, and Mr. Whitten on safety from the Langley Research Center. That group will, in general, look into the management aspects of the procurement of this hardware and its preparation for flight to see if there were any breakdowns in the system we've been using which may have been contributory. Now, although I haven't shown you this chart before, there are some staff boxes that we don't have to spend any real time on. The first one I mentioned the other day — that's a very important box actually. Mr. Mathews is heading up the OMSF Technical Support. That is, he's insuring that the Board gets everything it needs down here. And he's also working on how to interface with the investigation that's going on by the project, and just how do our members of the panel work with their counterparts in the Manned Spacecraft Center and the contractors who are really looking at the same questions. We have a council secretary to handle our records and papers, a Report Editorial Group, I think I mentioned that the other day, to lay out the manner in which we'll report this to Dr. Paine, Public Affairs, and Legislative Affairs, Mr. Mossinghoff. We've had one addition to the observers, Mr. Wilson from the House Committee on Aeronautics and Space, Congressman Miller's Committee.

CORTRIGHT: Now, that is the essence of what I wanted to tell you today. We're getting into the problem in some depth. We've been going through that period when everyone who starts to look at the data immediately invents his own explanation and has to discard it the next day. So, it's sort of a "getting humble" period, and I think we're almost through that, and we're starting to get our hands really dirty and understand what went on. I'm not prepared to issue any statement on that subject today, but I would ask you whether or not — or I might point out, rather, that there was a statement issued in Washington's part of the committee — the testimony of Mr. Petrone before the Congress today, which gave the timeline of significant events or the major events leading up to the incident. Have you all had a chance to get that yet?

SPEAKER: I believe so - -

CORTRIGHT: Well, it may be more current. I'll be glad to quickly read it for you if you'd like. The first event at — this is eastern standard time 10:06, oxygen fans were turned on. At 10:06 and 22 seconds, it was a high current spike in fuel cell number 3. At 10:06 and 36 seconds, there was an oxygen tank number 2 pressure rise. At 38 seconds, there

was an 11.3-volt transient on ac bus number 2, at 41 seconds, a high current spike on fuel cell number 3, and at 58 seconds, an oxygen tank number 2 temperature rise. At 10:07 and 45 seconds, oxygen tank number 2 maximum recorded pressure, and at 10:07, 53 seconds, there were measurable motions of the spacecraft. At 10:07 and 56 seconds, the oxygen tank number 2 pressure went to zero, and shortly thereafter Lovell stated that he had a problem. Additionally, Mr. Petrone made the following statements: "That the event was not a meteorite. The probability was calculated to be too low, for one thing." And also, "The telemetry is good enough and the number of events have enough information in them that it would appear not to be that rare coincidence of a meeting with a meteorite." He goes on to say, "From preliminary examination, it does appear that the observed rapid rise in the oxygen tank number 2 pressure would require an amount of heat much greater than that produced from current flow for the tank fans, heaters, and instrumentation operation. In other words, the electrical system could not alone pump enough heat into that — energy into that tank to raise the temperature of the oxygen as — and the pressure of the oxygen, rather, as much as was observed. This does not rule out electrical power as a source of initiation for some other energy source as yet undetermined. Analysis and tests are being made to determine what such an energy source could be and how it could have been initiated." That's all I have to say.

QUERY:

I'd like to ask you a question about what Dr. Paine said this morning. He referred to it as a relatively simple component in the number 2 oxygen tank, and he seemed to think the problem could be taken care of right away. Could you comment on that? What is this relatively simple component?

CORTRIGHT:

Well, here's what he said: "The oxygen thermos flask believed to be involved is a relatively simple component, and corrective action should not prove to be a major task." I think he was referring to the entire tank and its contained equipment as being simple. And I think what he — I'll speculate here — that he means it's simple compared with the rest of the system, and even if they had to do major things to that tank, that it probably could be done in time not to impact the schedule. But, I don't think he was precluding the possibility of some fairly major changes in that tank. But, the tank itself, you know, is a reasonable-sized device to have to cope with.

QUERY: Then you see possibly some major changes that will have to be done in the tank for Apollo 14.

CORTRIGHT: I wouldn't rule that out.

QUERY: Cortright, have you seen any indication at all which would give you a clue or a vague hint as to what possibly could have gone wrong? Anything at all to lead you into a general direction?

CORTRIGHT: Well, the obvious. If you're looking for energy in a tank like this, you have to say, "Well, what energy is there to start with?" And, you do have kinetic energy, you have moving parts, namely, the fan and the motor that drives it. And, you have electrical energy. You do know that there were glitches in the electrical system which would lead you to think there might be some electrical problem in the tank. And, it's not very mysterious, really. You can get short circuits with electrical equipment, and they usually are accompanied by glitches. So, that's certainly one possibility that would have to be considered.

QUERY: You didn't mention fires. Was there any danger of fires?

CORTRIGHT: Again, the major energy source, potentially in the tank, would be combustion, and if combustion took place, it's not certain exactly what it would be like with super-critical oxygen at those pressures and temperatures and the small amount of combustible material in there. We don't quite know what it would be like if it happened, but it could happen conceivably, and that could have been the energy source.

QUERY: Mr. Cortright, is there anything that you have eliminated as — besides the meteorite — as not being the cause?

CORTRIGHT: Now, we're not really going at it that way, yet. Now the Board has started by concentrating on that area that the experts here had determined as the probable source of trouble. And, we've spent most of our time trying to get to understand everything about that oxygen tank; how it interfaces with the rest of the equipment in the system; what energy sources are there in that tank and how might they be triggered; what type of chemical reactions could take place in the tank; would they look like combustion or not, and how might they be initiated? So, we are not really yet concentrating on ruling things out. We're trying to rule things in right now.

QUERY: Mr. Cortright, do I interpret that to mean that Mr. Petrone's statement today was his own; it was not based on anything the Board of Review had said? It was based on the MSC investigation? And, let me ask you further to follow Paul Recer's question, have you ruled out a meteorite?

CORTRIGHT: We haven't considered it abort yet, but I'm inclined to say "Yes." The odds would be extremely small that it could be that. As far as Petrone's statements are concerned, I'd say they are his own, and the way we're handling this sort of thing; statements of fact, insofar as they can be determined to be fact, are made by the Project. And, we draw on those same facts to help us in our investigation. So, in other words, if you have detailed questions about how vague were the current spikes and exactly when they occurred, the Project is releasing all that information as fast as it can pin it down. And, the interpretive part of it, apparently, they are releasing some of that too. I'm trying not to do too much of that now.

QUERY: Have you ordered any tests such as the effect of the electrical arc within this tank or some to that effect? Any tests using - -

CORTRIGHT: Tests are already under way by the Houston team. They are trying to determine in what way an electrical problem might have been a source of ignition, for example.

QUERY: To follow that question, have you ordered or requested that Houston investigators or any others go further in their investigations in any direction than they have been going and are you generally satisfied with those investigations?

CORTRIGHT: Well, I've been generally satisfied. We have made a suggestion or two which would constitute slight expansions to what was already being done, but generally, we've been satisfied.

QUERY: You listed some possible or potential causes that are being investigated. I wonder if you could run through a complete, you know, 1, 2, 3, of the possibilities that will come into consideration without weighing them in any relative value.

CORTRIGHT: I'd rather you get that from the Project.

QUERY: You plan to meet as --- in panels and perhaps one or two executive sessions a day.

CORTRIGHT: We do that. Generally speaking, we meet with Jim McDivitt and his people at 8 o'clock in the morning, to start the day off. And we get a summary of what they accomplished the day before. Then we have special technical briefings as we need them in the morning and otherwise operate as panels and subpanels during the balance of the day. We also monitor the technical meeting that takes place every evening at 6 o'clock, Mr. Arabian's meeting.

DUFF: It would make my life a little easier if you'd say what you plan to do over the weekend. If you don't, I don't have to.

CORTRIGHT: Well, if you know, I wish you'd tell me. We will work over the weekend, but at the moment, most of our days aren't planned very far in advance. We're still playing it by ear as we go along.

QUERY: Sir, I've been told that there's a report at Cape Kennedy that one source of the problem is thought to have been a motor driving fan which failed. That it's the motor driving the fan that failed. Is this true, or do you know?

CORTRIGHT: Well, that — the fan motor and the fan does constitute the kinetic energy you have and also constitutes a major electrical element, one which does use a fair amount of current. Yes, that's under close examination.

QUERY: Did it fail?

CORTRIGHT: No. I didn't say that. I'm sorry. I guess I misunderstood your question. It could have failed. It could have been the source of the problem. It's one of the potential sources.

QUERY: Do I understand correctly that there's no doubt whatsoever that the problem occurred within the tank?

CORTRIGHT: No. It's highly likely. According to the project here, the project office, that the problem occurred within the tank. And frankly, the evidence we've seen so far, also points in that direction. We haven't come up with anything different.

QUERY: Will telemetry tell you whether this fan motor failed?

CORTRIGHT: Telemetry may. There was a loss of some telemetry, as I guess you know, something like 1-1/2 seconds, and it may be possible to get a little more data out of that lost telemetry, which would help determine that problem.

QUERY: And do you still think that you can conclude this in 3 or 4 weeks?

CORTRIGHT: I think it's possible. It looks tight.

QUERY: Well, in order to do that, wouldn't you have to know where you're going?

CORTRIGHT: Yes. And that's why I said we haven't yet. Of course, we've only been here a couple of days — a few days, but we haven't yet seen any anomalies in the mission that point elsewhere. Everything points to this tank. So we're concentrating on understanding every possible failure mechanism of the tank.

QUERY: Are you as optimistic as Mr. Paine was this morning? He seemed to be rather optimistic that everything would be cinched up pretty fast and Apollo would be back on schedule very soon. Are you that optimistic?

CORTRIGHT: I think it should be possible to fix this tank up. Yes. But I — you know, when I look at a tank like that, I think, well, there's a good job here to be done, probably, and it will take some effort. But it's not as big an effort as these people have handled many times before.

QUERY: Talking about something as basic as a fan motor, all the other tanks have fan motors, don't they? Or are there - -

CORTRIGHT: There are other fans and other systems I believe, yes, that will have to be looked at.

QUERY: Does your data indicate there was a fire on board definitely and if so, what size fire?

CORTRIGHT: No. That conclusion has not been reached. All it indicates is that there was some source of energy in the tank large enough to raise the pressure above that possible with just plain electrical omni heating.

QUERY: Would you, in reference to that, that list you have there, indicate the 1-1/2 second data dropout?

CORTRIGHT: Well, the dropout occurred just at the time of the incident. In other words, when the apparent bang took place that's when they lost the data.

QUERY: How's that indicated on that list?

CORTRIGHT: I guess it isn't.

QUERY: Do you have a time for it?

CORTRIGHT: You can get that from the Project Office.

QUERY: Combustion in a tank would infer the presence of a contaminant, would it not?

CORTRIGHT: Not necessarily. Combustion can be different things, of course. Oxidation — rusting is combustion, you know, in a sense. So what we want to understand is if there was combustion, what was it that was oxidizing and how was it going about. It wouldn't have to be a contaminant. There are other things in the tank that could react with oxygen and metals and insulation, both.

QUERY: Dr. Cortright, when you say within the tank, you mean inside the sphere now. You're not talking about equipment associated with the tank or near it. You were talking inside the sphere of the tank.

CORTRIGHT: That's correct.

QUERY: I understand there's paper matting insulation between the two walls. Is this being left out as the possible source of combustion?

CORTRIGHT: Yes. I don't know whether it's paper or not. There's superinsulation in there. At the moment, the Board is concentrating and looking at the inside of the inner sphere, both the insulation on the wires and the possibility of contaminants and some of the metals themselves.

QUERY: You also plan to look between the two walls?

CORTRIGHT: We'll have to look at all that.

QUERY: — metal could react with the oxygen could you characterize that? The nature of the reaction that the metal prepared — you're not speaking about combustion in there are you?

CORTRIGHT: Yes. Aluminum can burn, and liquid oxygen under the right conditions.

QUERY: Blaze sort of thing?

CORTRIGHT: I don't know too much about that yet. I'd just as soon not try to answer that question. As you know, aluminum can burn in air.

QUERY: Is the Project Office or industry, or anyone else simulating any failure modes and if so, what are they?

CORTRIGHT: The Project Office and North American are both attempting to generate failure modes which could explain all the anomalies in the telemetry. And I refer you to the Project Office for the details of that.

QUERY: In reference to the picture that was released, could you tell very much from that picture what had happened?

CORTRIGHT: Not at first glance. But there are image enhancement experts working on the pictures now to try and get more out of them. In other words, it was difficult to tell much about the number 2 oxygen tank.

QUERY: Is there anything you detected in the photos that would indicate a fire? Any charring or that sort of thing?

CORTRIGHT: No, not to me but there was some staining as you recall that was announced by the astronauts themselves. A brown stain on the outside and I don't know what that means. That's being looked at.

QUERY: Would liquid oxygen itself leave a brown stain?

CORTRIGHT: I haven't any idea.

DUFF: Thank you very much.

APOLLO 13 PRESS CONFERENCE WITH DR. GEORGE LOW
MAY 1, 1970

DUFF: Press conference this afternoon with Mr. George Low, Deputy Administrator of NASA.

LOW: Good afternoon. I have just spent the day since early this morning receiving my first status report from the Apollo 13 Review Board. I received briefings this morning from Mr. Cortright, who is Chairman of the Board, several members of his panels, and also from Mr. Scott Simpkinson and Col. McDivitt and Don Arabian who are conducting the Apollo Program Office investigation here at the Manned Spacecraft Center. There is a major effort on the way, as all of you know, to determine the cause and the possible fixes for the Apollo 13 accident. I don't have an exact number, but I would estimate that between two and three hundred people are working on the problems associated with this event. We do have excellent telemetry data, and a great deal of information from the spacecraft about the sequence of events that occurred on April 13, about 55 hours into the flight of Apollo 13. And as we said before, the major source of information is the telemetry data. We also have photographs of the service module taken after the service module was jettisoned just before reentry. And as of today at least, the information given by these photographs is still inconclusive. Specifically, there is still no firm decision based on the photographs as to whether the oxygen tank number 2 was still in the service module at the time it was jettisoned or not. Review work is on the way in enhancing the photographs, getting the maximum possible information out of them, but it is certainly not clear that we will ever get that answer from the photos themselves. In addition to the telemetry and the photograph, there's also on the way now a very significant effort of tests and analyses. And it will take a combination of all of the data from telemetry, from all of the testing of all of the analytical work, and perhaps information from photographs to determine the most probable cause or causes for the event that took place on April 13. But from what I've heard today, and from what I've been told previously, I'm fairly confident, quite confident that we will be able to bound the problem, that we will be able to determine its limits, and that we will find corrective action that will encompass all possibilities. Both the Board and the project people told me today that the most probable sequence of events on Apollo 13 was as

follows. First, a short circuit occurred in oxygen tank number 2. This short circuit most probably caused combustion within the tank. This in turn caused the pressure and a temperature within the tank to increase. The tank then ruptured. This rupture of the tank caused the pressure in the compartment in which the tank is located to increase which then caused the panel, the big covering panel in the service module, to blow off. And if at any one fact then that I had not known before today is that the blowoff of the panel most probably was when the panel flew off and then hit the high gain antenna which temporarily knocked it out for a matter of a second or two and this led to the loss of data for that very short period of time just about the time that the panel did fly off. We also discussed today the preflight events that might be of importance in connection with the Apollo 13 accident. These included the facts that the motors, the fan motors, the fans inside of the tank were changed early in the manufacture at the vendor's plant; later on the tank, itself, was removed and reinstalled; moved from one spacecraft and installed in spacecraft 109 and during the removal from spacecraft, I believe it was 106, it was jarred or dropped an inch or two, and this may or may not have had an influence on the well-being of the tank. Finally, during the loading and unloading of the tank during the countdown demonstration tests at the Cape, there was an anomaly which made it very difficult to get the oxygen out of the tank. This was several weeks before the flight and a new procedure, not previously tried, was used in this detanking. These three factors are also being looked at by the Board and by the Review Team to see whether there's any possible connection between those and the accident, itself. The Board, today, estimated that they will make their final report to Dr. Paine and myself about the first of June. This is a very brief summary of our discussions today. I also spent time this afternoon then with Dale Myers and Rocco Petrone and Jim McDivitt and discussed possible alternatives of design changes that might be made to the spacecraft without in any way prejudging what the conclusions of the report would be. But no decisions in any such changes have been made at this time. Be glad to answer any questions you might have.

DUFF: We'll start with Art Hill and then go back.

QUERY: George, how certain can you be that a short circuit was responsible for initiating this series of events?

LOW: As I said, Art, the conclusion by the Board and the Review Team was that this was the most probable initiative of the events. I don't think that anybody, as of today, can be positive that this was the — that this will be the final answer, but, as you know, there were a number of electrical glitches, high currents, low voltages, just preceding the rest of the events and the investigation today was focusing in that direction.

DUFF: Ed DeLong.

QUERY: In what component would you estimate that that short circuit happened and when you say combustion in the tank, does anyone yet have any idea of what combustion in a high pressure LOX tank is?

LOW: First question, what component — what component did it happen on. Short circuit could only be in the wiring leading to the fans, to the temperature sensor, to the quantity gage or to the heaters. Now the preliminary conclusions today are that the heaters were not powered at the time, so they're eliminated. And the current to the quantity sensor and to the temperature fills were so low that they are unlikely components. So the most likely source would be the current to the fans.

QUERY: Before you go further, you say wiring leading to the fans. Would that include wiring in the fan motors themselves?

LOW: It could certainly include that, yes.

QUERY: What component reacted or where was — where did the combustion take place?

LOW: Again, the people have looked at what might burn in this oxygen environment, and it would have to be the insulation on the wiring or the wires themselves or some of the aluminum components.

DUFF: Paul, you had one.

QUERY: Have you all simulated this failure with the tank rupturing, and if so, does it cause shrapnel that would damage other components in the same bay?

LOW: The complete simulation — there has been no complete simulation of the tank rupturing or of the entire events in the full-scale tank, and it is certainly not clear today whether the tank would rupture or whether it would spring a leak or whether it would open a small hole only. I was told today that all possible tests are still being examined and that no firm test plan has yet been developed. Again this will depend in part on the analyses and part in the small scale tests and part of it is also the — of looking at the data before the people here will come up with a plan for an overall test program.

QUERY: Dr. Low, you indicated that during the countdown demonstration tests at the Cape that there was what you said was an anomaly which caused difficulty in detanking the O₂ tanks. The other two factors were physical factors like a fan changed or dropped. This is a procedural change. Would you explain how that could possibly be a contributory factor to the series of events?

LOW: Only in that it may — well, first of all it may have — going back to this prelaunch event now, the — at the time that it was difficult to detank the oxygen, an analysis was made and it was concluded that there could have been a buildup of tolerances between various types in the stand-pipe and the vent line that could have led to this difficulty in detanking. In looking back over the records, one can then ask the question could the detanking difficulties be an indicator of something else being wrong inside that tank, and we don't know today that it was. Also, could the specific procedures in the detanking have caused something else to be damaged? For example, during the detanking the gaseous oxygen was pumped into the tank and released again, and the heaters were turned off and on. These procedures are now being examined in detail by the Review Teams and by the Board to see if any of it could have had an effect on the tank itself.

QUERY: George, at what point in the history of the tanks were the fans changed and why were they changed and was it both fans we're talking about or just one or what?

LOW: At what point in history were they changed? Before the tank was delivered to North American, I believe, so while they were still at Beech. They were changed, I believe, because there was a reading of voltage or current or something that was not completely within specifications, so they were removed and a new set of fans was installed.

QUERY: So the fans that were in the tank that the explosion occurred in were new fans?

LOW: As far as I know, that's right. They are not the original fans that were removed at the vendors.

QUERY: The old fans weren't fixed and then put back in, or anything like that?

LOW: I don't believe they were.

QUERY: Sixty-six are we not - -

LOW: I don't know the date, but I would imagine it was at least that early.

DUFF: We could help perhaps afterward by going back and finding some of these. Do you have a question?

QUERY: Two or three here. One, do you have any idea what combustion would be — I mean, would it be flame, what would the physical process of combustion be under those high pressure or low temperature liquid oxygen conditions? Two, yesterday we received from, I gather Jim McDivitt's group, although it came out through the Public Affairs Office and was not tagged specifically as to who it came out through, very firm assurances that, although the shelf had been dropped an inch, this did not contribute to the problem and you seem less certain of that. Could you explain that a little bit, and has there been any speculation at all about what might cause a short circuit and what do you mean when you say short circuit; do you mean two wires crossing, do you mean something stalling the motor and overheating it, what's included there?

LOW: To the first question, do you remember it? Okay, what is combustion like in that environment, its supercritical oxygen at minus 150 degrees and 900 pounds pressure. I really don't know. We had an interesting discussion about this at lunch time, whether — I asked whether we had ever seen or been able to take pictures of something reacting violently in that environment. And I was told no, we had not yet, at least the people here had not seen this, and we are going to look at the possibility of putting a window or a port into a test model so that one can take films of this. So combustion really means a violent reaction, release of energy of so many Btu's which are needed then to increase the pressure and the temperature. I don't think

anybody today can really answer that question in any more detail. The second question concerned the — I try to point out here the three things that we discussed that were anomalous in the preflight situation. The fan change and the removal of the oxygen shelf, and the 2-inch drop that was involved there, and third, the detanking. And I brought these out only because they are unknowns today; I mentioned also that at the time that the shelf was removed and was dropped a couple of inches there was a normal discrepancy procedure followed; in other words, it was examined and was looked at, it was analyzed and the conclusion reached at that time was that certainly the tank was all right to reinstall, where it would not have been done. What the people are now beginning to do is take a look at this again, to reanalyze what might have happened at that time, to see whether higher loads could have been imposed on it than was known at that time, to see whether anything else could have happened that was overlooked at that time. And I mention it only in that light. And if — do I have them all?

QUERY: What do you mean by a short circuit?

LOW: A short circuit means an abnormal flow of current which could be caused by insulation missing off the wire, or the wire touching the ground or it could be almost anything.

QUERY: Does that include the fan motor stalling?

LOW: My recollection from previous knowledge I have had is that the fan motor even in the complete stalled condition will not generate enough heat to cause any kind of a problem.

DUFF: We will get Jim because we haven't gotten to him yet, then we are going to Washington for a few questions, then we will come back.

QUERY: Will any or all of the fixes that you have discussed delay the launch of 14?

LOW: I don't know. I think the important thing here is to fix what went wrong. I should have mentioned, of course, that everybody here is also looking at all the many other possibilities in many other areas where similar or related events might occur. So we are going to take whatever time is necessary to make right what went wrong, and until I get the complete Board report, and this may not even be on June 1st, this was the estimate today, if they need more time, they

will get more time to do their job, and until the job is done both by the people here at MSC and by the Board, we won't really know whether or not we will delay Apollo 14.

DUFF: We are ready for questions from Washington now.

SPEAKER: Okay, please wait for the mike now. Don.

QUERY: George, could you tell us when and where the tank jarring occurred?

LOW: Where and when the tank jarring occurred; it occurred at the North American Rockwell Factory in Downey. And it therefore occurred before the spacecraft was delivered. We will have to get to the exact date; I don't have it. I am told November 68.

QUERY: George, could you tell us — you were speaking of separating the oxygen tanks takes some equipment change to do that. Are you also thinking — 1 to 3 months in this whole thing?

LOW: I missed the middle part of the question. Could you repeat it please?

LOW: Could you repeat the question, please. I did not get it.

QUERY: George, are you thinking of separating the oxygen tanks some physical way, not putting them into a different bay, but maybe armor plating them? Are you also thinking of removing the fans and the heaters and any other source of electricity, and if you are thinking of this, wouldn't this mean a delay of anywhere from 1 to 3 months in Apollo 14?

LOW: First question concerned the separation of armor plating of the tanks. This is being looked at also, but it is as of today not proposed as a solution. The removal of fans, specifically the removal of fans, and the changing of the wiring to the heaters instead of removing them or even the possibility of removing them is being examined by Jim McDivitt and his people. Again, no decision has been reached. As far as time is concerned, I cannot give you an answer. I know that there was a time when we launched Apollo flights on 2-month centers and made some very major dramatic changes in those fairly short periods of time. As I said before, we will take whatever time is necessary to fix it.

DUFF: All right. I am told that October is the correct date.

QUERY: Dr. Low, while you were talking about the change and relocating them and so on, you discussed something in general about what design modifications you talked to Jim McDivitt and also what area is it you're looking into where you could through a single event lose your safety redundancy other than the - -

LOW: I can answer the first question. The design changes today are the only design changes. They have not yet moved out on any hardware changes. The design changes that are being looked at include the removal of the fans, the changing of the heater wiring, or the heater location so that all of the wiring into the heaters can be enclosed in a metal sheath going to the outside of the tank. The relocation of the quantity probe or the redesign of the quantity probe to remove the aluminum in it, and at the same time make it possible to assemble the heater and probe device without needing flexible wiring leading to them. And the removal of all nonmetallic materials from inside the tank, and the removal of aluminum and anything else that may react with oxygen. Now, again let me emphasize that these are changes that were being discussed and not yet being perused at North American. At the same time as looking at these and other changes and until all these get together, no decision has been made on any changes.

QUERY: - - some of the possible errors where you could lose your redundancy.

LOW: This we did not discuss today.

QUERY: Did you say McDivitt has some people looking into those other possible areas?

LOW: Yes.

QUERY - - yesterday that after they're manufactured the oxygen tanks were rejected two times before hastily being accepted on the third inspection as the deadline approached. Would you comment on that?

LOW: This is the first time that I've heard this. We'll certainly look into it and get you an answer. I have no information on this.

QUERY: Well, I'm kind of confused on this fan. When you changed out these fans, did you put back new ones of the same model or were they different models, different in design than the fans that had flown on all the previous Apollos?

LOW: The fans in Apollo 13, to the best of my knowledge, were the same fans that we had flown in previous Apollos. The fans that were removed from the tank back at the vendor's plant apparently did not quite meet specifications when they were tested in the tank. They were rejected, removed, and other fans of the same kind were reinstalled.

QUERY: Okay. Did this happen in any previous Apollo flights, that you had to remove the fans?

LOW: If it did, it was not discussed today.

QUERY: Dr. Low, again along with Paul's question, could you compare these anomalies with anomalies of similar nature of other Apollo flights? Have you had things of this nature happen on other flights that you might be able to compare with the anomalies on 13?

LOW: It's hard to form a comparison. We had, of course, some anomalies in every Apollo flight. None of them was as critical, none of them could potentially lead to as catastrophic a result as the anomalies on Apollo 13 could have led to. Going back in history, of course, we had Apollo 6 where we lost 3 engines on the Saturn V launch vehicle on the way out and had a very — had the POGO problem on the first stage and also had a very major damage to the service module LM adapter. Apollo 7, I don't remember the list. We did lose, during the flight of Apollo 7, momentarily all ac power as you'll recall. Apollo 8, we had very few, although the list of details was quite long still. Apollo 9, you're making me go back in memory here, but we had some kinds of problems in every flight, up to and including the computer alarms on Apollo 11 and the lightning strike on Apollo 12, but none of them, as I mentioned before, were potentially as catastrophic as these might have been on Apollo 13.

QUERY: Well, I was basically thinking that — not of the overall flight but on the LOX tank itself. If you could compare all of the Apollo LOX tank situations, what would 13 look like? Would it look like really a bad tank and if you'd have compared them all would you have gone with it?

LOW: I can't answer that question. It is not at all unusual to have countdown problems or countdown demonstration problems and — because this is why you conduct a countdown demonstration in the countdown. I remember in Apollo 9 we had a very significant problem the entire night before launch on the supercritical helium tank where we did not know whether we had a blockage in the tank or not, and we decided at that time that we were satisfied that we understood the problem as we did on Apollo 13 on the oxygen tank, and went ahead with the launch. That's a related problem in that they were both cryogenics that we had a problem with and only in that sense. I don't think you should consider any single countdown problem or a single countdown demonstration problem or a single check-out problem at the Cape to be unusual. We've changed engines, we've changed fuel cells, we've done all of these things and that's why you conduct tests at the Cape. It's only today in retrospect, now that we've had the accident, we're looking at the procedures again, that we're looking particularly at the procedures in connection with that tank to see whether that could have had an effect on what happened later in the flight.

QUERY: If you're moving the fans from the tank, what mechanism would be used to stir that oxygen? The second thing, what is your opinion now of the possibility of flying another Apollo flight this year?

LOW: The first question is a technical one and even that does not have a complete answer, Jim. Based on information by Jim McDivitt and his people to date, it is possible that we can conduct the flight without stirring the cryogenics with the fan. This is based on looking at all the information from all of the Apollo flights to date and looking at the times and the fairly long times that we've gone on some of these flights without turning on the fans, it appears to be possible to eliminate the fans entirely without replacing them with anything else. This is not yet a firm conclusion. What is the probability of an Apollo 14 flight this year? I can't give you an answer.

QUERY: You talked about the possible design changes in the hardware. How about design changes in the flight, itself, the trajectory and the use of this hardware. Specifically, there has been a suggestion that you might possibly carry the ascent stage back as a possible lifeboat. Is there any consideration being given to design changes in this area?

LOW: That was not discussed today and has not been discussed with me at all, so I really can't answer that. I don't know whether or not it is being considered and if it is being considered, whether it has a positive outlook or not.

QUERY: Dr. Low, based on the thinking of your investigative Board that it can have a final report ready for you and Dr. Paine by June 1st. Does this mean that you have arrested a prime suspect and now you're just going to give the guilty party a fair trial the rest of the month, or have you got some other —

LOW: That's a good way of putting it. No, I told you all that I know. However, the people here are quite confident, that given another week or two of proceeding with the analysis, of doing some of the tests that are underway, that they will have enough information to bound the problem to decide on the design fixes. Now, it may be, as I said before, that they will not be finished by the first of June or it may be that they will give a report on the first of June and we'll ask them to reconvene in July or August or some other time to again look at what has been going on within the Program, and to make sure that all the loose ends, if any, will clean up.

QUERY: Among the possibilities of solving this problem, have you considered any that are not directly related to the structure itself, such as carrying another set of bottles or dividing them into two small bottles, or carrying a reserve supply somewhere else so that a flight would not be impeded?

LOW: Yes. I listed, a moment ago, those avenues that the project people here are looking at most seriously, today. They, then, have a whole list of other things that they are also looking at which include, perhaps all of them that — all of the ones that you have mentioned.

LOW: Have it one at a time, Ed.

QUERY: Okay. You reminded me when you mentioned the POGO problem and the engine failure that we did have an engine-out on this flight and that I have heard some project people say that if there is a delay in 14 that the fixes for that engine-out may be more responsible for it than any modes to the spacecraft. What is the status of that engine situation and how accurate is that assessment of the possibility of delay?

LOW: Ed, I know that people at Marshall are working very hard on that. I have not been briefed on it, and I have not reviewed it, and I honestly don't know.

DUFF: Thank you all very much.

APOLLO 13 REVIEW BOARD CONFERENCE
JUNE 2, 1970

CORTRIGHT: Good afternoon. The purpose of this particular conference is to bring you up to date on where the Apollo 13 Review Board stands, tell you a little bit about why we've delayed our report and a little bit about what our prospects are of making the current date. Now, in particular, I want to tell you something about the tests that are going on. I will refer to a few notes here in which I hope I didn't leave anything out. First of all, let me say that the general status of the review is that it's nearing completion. I'm generally satisfied with the results that have been turned up in the investigation to date. I think the understanding of the accident is good. We've delayed the report, as I mentioned in a bulletin which came out within the last few days, because there are critical tests being carried out which will help pin down some of the details of what took place. The Board has not been satisfied until recently that these details were pinned down. There are still a few key points to clear up.

Now, the tests that are being carried out are being carried out all over the country. For example, here at Manned Spacecraft Center, there are a number going on. They are also being conducted at Ames Research Center, Langley Research Center, Marshall Space Flight Center, Kennedy Space Center, and at North American Rockwell, Beech, Boeing, and a few other places. One of the key tests is — one series of tests relates to this special detanking procedure, which you heard about before, and the checkout proceedings at the Cape prior to launch. Now the tests so far have found the faulty thermal switches, or the failed thermal switches, which were mentioned the other day. They've also demonstrated that if these thermal switches had failed as we now are relatively certain was the case, that the temperatures that would have been reached in the heater tube assembly could have exceeded 1000° F in some spots, although not everywhere. There were tests conducted here at the Manned Spacecraft Center that showed that when the heater assembly, the heater tube assembly, reached temperatures like that it baked the Teflon-coated wires and destroyed the insulation. And a little bit later I'll show you some samples of this insulation and what happens to it when it's baked in an oxygen environment. Now the clincher is going to be conducted at Beech Aircraft Corporation this week wherein an actual flight tank will be cycled back through

the same series of detanking operations that took place on the oxygen tank no. 2 from Apollo 13. These tests began yesterday with a normal detanking and will proceed now into the special detanking. Following the tests, the tank will be disassembled and the wiring damage examined.

Another series of tests that are appearing important are being carried out at the Manned Spacecraft Center, the Ames Research Center, and the Lewis Research Center relate to the ignition and combustion processes in the tank. Now the first tests on ignition of Teflon by means of an electric arc were run at the Ames Research Center; they demonstrated very low ignition energies. In fact, the initial test indicated less than 1 joule of energy and the short circuits that were measured in flight showed energies of at least 20 times that — 10 to 20 times that. Subsequently, the values required to start an insulation fire in the tank fluctuated a little bit, but generally seem to show 1 joule or less minimum energy, if the fire or ignition were by means of an electric arc. Just plain heating takes a lot more energy, but an electric arc concentrates the heat. The most recent test at Ames has shown that if the wire is baked in an oxygen environment and damaged, it still ignites and burns much as if it were in its original condition. Now, the test at the Lewis Research Center was designed to check these phenomena in a zero-g environment. Now, the way this is done is that there's a facility at Lewis which consists of a tank which is dropped from a 500-foot tower. Actually, it's dumped into a 500-foot hole and I think you can get 5 seconds of zero-g flight that way, and if you toss it up from the bottom and let it get almost to the top and come back down again you can get 10 seconds. Basically what they've shown in the combustion rate or propagation rate tests is that in one-g the rate of propagation of combustion along a Teflon-insulated wire depends on whether it's traveling up, down, or sideways because of the convective currents. The direction which most nearly simulates zero-g is down, and that is about twice the rate that really takes place in zero-g. These are just rough numbers, but they are generally right and all of this information has been determined since the beginning of this test program.

As far as the tank rupture is concerned, there has been a lot of question about just how much of a rupture it was, and the guesses have ranged all the way from a small half-inch hole, which might have occurred if a conduit burned out at the top of the tank, to total rupture. Now, here's why that's important. We feel that we'd like to know how much

the tank ruptured so that we can understand what caused this rupture. We can readily conceive of a burnthrough at the top of the tank because there are many wires that come together at the top of the tank and run out through this small conduit. This makes sense to us. Tests were just run here the other day that showed that not only might that small conduit burn through, but as much as a 2-inch hole in this particular case could burn through very rapidly.

Now, this ties into another series of tests, and that is how the panel came off the service module. The pulse required to take that panel off has been under study at the Langley Research Center with a very large crew of people working on this problem. The service module bay 4 has been mocked up in about one-half scale, and so far I think a series of about 15 tests has been run to attempt to pop the panel off in a realistic way, and this has all been scaled dynamically and structurally so that it does simulate the actual conditions. The first thing that was found out was that if you pulse a very rapid pulse in a local area, which simulated a very rapid, rather large rupture of the tank, it tore a hole in the panel. But if the pulse were just a little bit slower and gave sufficient time for the gas to spread throughout the whole bay and pressurized that panel fairly uniformly, it came off completely, and it came off at about the pressure it was designed for, which was between 20 and 25 psi. Now, there was some problem with these tests in the sense that the slow pulse which took the panel off pressurized some of the rest of the service module more than we think happened, because under one condition the pressure could have separated the command module. The command module was designed in such a way that if it had been pressurized at its heat shield area to 10 psi about, it would have come off. So we have been looking for a pulse that would take this panel off more abruptly and get it all off and this was achieved yesterday morning where we were running our second honeycomb reinforced panel. Prior to this test, the panels were single sheets simulating the tensile strength and the membrane properties of the actual panel. Some of the stiffness properties were injected the other day when we got our first scale honeycomb panels. They have now come off in total, not in one piece, but they've all come off with a sharp local pulse of the type we think occurred.

We've also been running extensive theoretical calculations at Langley to try to relate the shape of the pressure wave

and the total energy in it to what you might expect from various size ruptures in the tank. We're getting close to a match but we don't quite have it yet. Now if we've got a 2-inch hole in the tank, and we're not sure we did get it, just one test sample showed a hole about that size, that would about give the right size pulse. If it was something less, we might need an augmented pulse. There's one way you can get an extra kick into that pulse, and that is by burning of the Mylar insulation was right over the top of the tank. There's a test being run at Langley today to try to demonstrate that if the tank had burst, flooded the Mylar insulation with liquid oxygen, or a spray of liquid and gaseous oxygen, and had ignition sources present (which would almost certainly have been there with a burnthrough at the top of the tank) it would in fact, ignite and supplement the pressure pulse from the cold gas alone. Now this isn't quite pinned down yet. Obviously, I'm giving you some information in advance of conclusive results but I'm doing this so you'll understand what we're about. I guess the last thing I would say then is that the tests are all coming to a focus here this week. It's going to be very difficult to get the report in by next Monday. The Administrator is not putting me or the Board under pressure to get that report in but rather is urging us to take the time required to do a good job and we're going to do that. So that if additional time is required, we'll take it. I won't know for a few days yet. That's what I thought I would tell you, except to answer the questions.

QUERY: Would you just summarize for us the probable sequence of events that happened on Apollo 13 based on all the knowledge to date?

CORTRIGHT: Where do you want me to start?

QUERY: When the problems developed, what had happened that lead up to this problem on Apollo 13 ... based on the investigation?

CORTRIGHT: Well, I'll tell you part of it but I don't want to attempt to give you the whole sequence because there's some steps in it that we're still debating. In fact, I have to leave here before too long to go back and participate in a meeting with officials from the prime and subcontractor who built this tank to discuss some of the events that preceded the accident. But in a gross sense, it was believed to be something like this. The switches which failed at the Cape, we think, were not rated to the voltage levels to which they were subjected at the Cape. Normally

they would not have been opened under these voltages at the Cape, but they did so in the special detanking. This higher voltage failed the switches in a manner in which they could no longer function as protective thermostats. This in turn resulted in the heaters operating for a long period of time without interruption. The heater tube assembly reached temperatures which we suspect, locally, may have been as high as 1000° F. We have demonstrated that this seriously damages Teflon insulation. In flight, when the fan motor wires were energized for a normal stir of the oxygen, they short circuited at a point where the insulation had been damaged by this heater cycle. The short circuit was of such a nature that it created an electric arc which, in turn, ignited the Teflon insulation. The Teflon insulation burned towards the top of the tank. When it reached the top of the tank it ignited additional Teflon insulation around other wires which come together there, creating a local furnace which burned through the top of the tank in some manner. The high-pressure oxygen rushed out into bay 4, pressurized it with a sharp quick pulse, separated the panel, damaged the oxygen tank no. 1 system, resulted in the total loss of oxygen and power ultimately.

- QUERY: What evidence is there that this happened before launch? The switches were damaged before launch?
- CORTRIGHT: The tests the other day showed — indicated that the switches can weld closed when they attempt to interrupt a current of the strength which was used at the Cape during a detanking procedure. Now the details of that, with regard to the actual rating of the switch, how it came to have that rating, I'm not prepared to discuss that today.
- QUERY: How many times were the fans used before the explosion and why?
- CORTRIGHT: I don't have that count, but they were used.
- QUERY: More than once?
- CORTRIGHT: Yes.
- QUERY: Who authorized this special procedure for detanking?
- CORTRIGHT: This was authorized through normal procedures at the Kennedy Space Center with checks with responsible individuals.
- QUERY: Had they ever been used before?

CORTRIGHT: No.

QUERY: Do you know why they had trouble with these tanks?

CORTRIGHT: We suspect a loose portion of a filter assembly in the tank but I'd rather defer discussion of this aspect of it. I think I will defer at about this point because there are elements of it that are not yet clearly established and they will be in the final report to the Administrator which I'll make next week.

QUERY: Why was the failure of switches not discovered early in launch?

CORTRIGHT: The ground support equipment which monitored the tank did not readily or visibly display the heater operation and the operation of those two switches.

QUERY: And was no special step made to check those switches due to the fact that they had been taken above their rated voltages?

CORTRIGHT: No. I defer that question for the next time we get together.

QUERY: Well, what kind of voltage did your tests show? What voltage did the switches draw?

CORTRIGHT: 65 volts dc.

QUERY: When you said there was nothing on the ground support equipment, what do you mean, there was no indicator or gage or something, or what?

CORTRIGHT: I'm not sure I understand your question.

QUERY: You said there was nothing on the ground support equipment that would indicate the heater operation and the operation of the two switches?

CORTRIGHT: The voltage of the equipment is recorded but as far as I know, and this is one of the things we're checking into, there is no convenient way that would illustrate the cycling of those switches to the observer.

QUERY: Do you have a detanking procedure which was not normal, which had been described to us since is very strenuous, hard on the equipment, etc.?

CORTRIGHT: There were tests run in support of that operation to determine whether or not it was a safe procedure to follow. There was no mechanism hypothesized that could damage the tanks.

QUERY: No special tests were run after the procedure was completed to back check the two switches?

CORTRIGHT: I feel it's very important to be accurate in regards to this switch malfunction because it probably was the final thing that occurred during ground tests which caused the accident. I think it'd be seriously wrong on my part to speculate in any way.

QUERY: Cortright, you say that welding occurred at 65 volts dc?

CORTRIGHT: I'm not exactly sure of the exact number so I'd rather not answer that.

QUERY: Dr. Paine testified on May 19 before the Senate Appropriations Committee that modifications are being made. Is that true?

QUERY: What does that mean?

CORTRIGHT: It means that work is going ahead as planned.

QUERY: But no nominal gain made, is that right?

CORTRIGHT: The fix has not yet been authorized.

QUERY: As I understand it, this heater switch business is something that you became fairly sure of last week, is that correct?

CORTRIGHT: Yes.

QUERY: That would have been after Dr. Paine said that modifications are being made, it raises a question of will this necessitate further modifications?

CORTRIGHT: This switch, I believe, had already been taken out for subsequent flights prior to the accident, and the discovery of the switch problem merely helps us be certain we knew what happened. It doesn't change the approach to the fix.

QUERY: What about pinning the fault of the explosion on the detanking operation? Does this mean that whereas the detanking

in the past has been sort of thought to have been a one-of-a-kind failure and there may be some modifications coming out of it now? Further modifications?

CORTRIGHT: I don't believe that the normal detanking procedure will be changed as a result of what we learned. Certainly the special KSC detanking procedure will not be followed again.

QUERY: This sounds like not an equipment failure, but human failure in not using the equipment properly, is that right or not?

CORTRIGHT: There appears to have been a mismatch between the ground support equipment and the switches which were used on the spacecraft, and what we're trying to pin down now is how that occurred.

QUERY: You're saying that the people conducting the test felt that these switches could handle the current used in the test. Did they use too much current?

CORTRIGHT: It was too much for switches that were on board.

QUERY: Are you saying in essence that you think it means they know what kind of switches were on board?

CORTRIGHT: Yes. They didn't know that the switches would not handle that current.

QUERY: Had there been a change in switch specs somewhere along the line?

CORTRIGHT: I understand why you want the answers to all these questions, but I am not prepared to give much more than this today because I don't have all the answers yet. As I say, we're meeting at 3 o'clock, to attempt to pin some of these things down. If I attempt to answer any more questions about these events, I'll be changing the answers tomorrow...

QUERY: ... switches to be set, was this known?

CORTRIGHT: It was known to some.

QUERY: To the people operating the ground support equipment?

CORTRIGHT: No, I said that they -

QUERY: The people operating the ground support equipment.

CORTRIGHT: No, I said that they felt the switches were rated at the level to which they were using them.

QUERY: Has NASA called for or requested a change in switch specifications anywhere along the way here?

QUERY: What are the switches rated at? What were the switches that were in there rated at? We've got 65 ...

CORTRIGHT: We're double checking that, and we'll tell you when we know.

QUERY: You said that this thermostat switch had been taken off in future flights?

CORTRIGHT: I think so.

QUERY: Do you know why?

CORTRIGHT: Pardon?

QUERY: Do you know why that it was taken off?

CORTRIGHT: I'm not positive that I have all the information on it, but normally those switches are never used. They would normally be used in very unusual condition where the oxygen in the tank got down to a few percent of maximum during flight, and the tanks aren't used that way. But they were used that way during this detanking procedure.

QUERY: The switch removal then is not one of the steps that you ordered as part of the fire proofing procedure?

CORTRIGHT: No, sir.

QUERY: These switches, are they inside the tank, outside, or where?

CORTRIGHT: They are inside the tank, mounted on the inside of a heater tube, near the top.

QUERY: Then Apollo 13 would have been the last flight to the best of your knowledge at this point in time that would have had those switches in it?

CORTRIGHT: I'm going to ask Brian Duff to check that for me. I'm not certain. That's my recollection.

QUERY: We've got one question from Washington. Wait a second.

QUERY: ... and the mismatching of switches in GSE, etc., are you coming to the conclusion that perhaps there has been over a period of time ... a letdown in quality control and attention to detail that's got to be shaped up?

CORTRIGHT: We're not going to come to that conclusion today. We're trying to reach conclusions so that we can make recommendations to the Administrator next week. I guess that will have to be my answer for today. Let me say one other thing in answer to that question. I have not detected any letdown in quality assurance as set up for this program and as carried out. In fact, we have found that the quality assurance program is about the most rigorous we've ever seen and that it's carried out to the letter. That does not mean that the best systems can't let things slip through occasionally.

QUERY: You said that the ground support people didn't know that that switch couldn't take that current but that some people did know it. Were these some people that were at the Cape that were involved in the procedures?

CORTRIGHT: We're trying to determine today and this week who did and who didn't know and what information was exchanged among them.

QUERY: You certainly have given an overall impression at least that there was either a substandard switch involved or that some documentation along the way didn't get passed along, or that something in this area probably occurred. Is that what you're looking at, at least is that possibility you're looking at?

CORTRIGHT: I think it's clear that a mistake was made. That's what we're looking for.

QUERY: Does it look more like a hardware mistake or a documentation mistake?

CORTRIGHT: I'm not certain just what aspects have been ... most significant.

QUERY: Then why ...

CORTRIGHT: I'd rather not get into a discussion of this today, if you don't mind.

QUERY: Dr. Cortright, how did you come to suspect the switches? Was it because the detanking procedure was a deviation from the normal way of doing things, that an investigation of this type you would normally look into a thing like that?

CORTRIGHT: That's the first part of it. It was an abnormal thing. The tank failure was abnormal. You try to put two and two together. We did recognize immediately that if those switches had not operated that the heaters could have gotten quite hot, so we undertook with the Manned Spacecraft Center to conduct tests to determine how hot the heaters might have gotten. In the process of conducting those tests, the switches actually failed in the manner I described. It wasn't actually during the test of the switches themselves but they did weld themselves shut and therefore pinned down a key step in the whole process.

QUERY: Well, do you feel that the sequence was a failure? When the switches failed at Cape Kennedy and generated possibly 1000 degrees of temperature, this in effect did some baking of the insulation. Subsequently, use of the fans and the heaters continued to bake and on April 13 the insulation just gave way and arced. Is that what happened? After a continual exposure to this high heat?

CORTRIGHT: We expect that the insulation was in bad shape at launch and just why it took as many hours as it did to strike an arc we don't know, but there are mechanisms that you can speculate on. For example, there are wires that are relatively free. They are loops in the tank, and these loops no doubt do some moving around each time the fans come on and stir the fluid. They conceivably get moved back to a point where they had once been in contact with the heater and were damaged, and if at the time they moved back they were bare, partly bare because of the damage, it would strike an arc. That's one way it could happen. We may never know.

QUERY: Do you have a certain amount of sloshing in those tanks by just attitude changes? Do they slosh ... ?

CORTRIGHT: Well, sloshing is not the right description, but a gentle reactive motion.

QUERY: The loops — the wires could move within the tank in this kind of motion?

CORTRIGHT: Yes, but when the short circuits took place was immediately following turnon of the fans.

QUERY: When was it first discovered that more voltage was applied to the switches than should have been?

CORTRIGHT: Last Wednesday. We reported it to you last Thursday.

QUERY: Was that just a studying of documentation of test at the Cape? Is that right?

CORTRIGHT: That was by having the switches fail during the ground tests and attempting to understand why they failed.

QUERY: How did you become positive that the switches were failed at the time of launch? Is this hypothesis based on these tests or was there some documentation that you could go back to for the GSE to determine this?

CORTRIGHT: The records I've seen to date indicate that the rating of the switches was lower than the voltage supplied to them and that this makes it seem rational that since they failed in ground tests at the voltage used at the Cape, that they in turn had failed at the Cape. Now, some of the tests that are being run this week, and I'd like to make a strong point of this, are to validate in fact that these switches would normally fail at the applied voltages and that it wasn't simply an odd occurrence here in a test at MSC.

QUERY: That's the purpose of the voltage test for the flight model?

CORTRIGHT: Actually — excuse me, I want to answer that question. That isn't one of the main purposes of that test and I don't know what configuration those switches are in in that tank; they may, in fact, be wired closed. But there will be more switches tested here to get a little bit of statistical sample as to whether they would always weld closed.

QUERY: Would you run through in a very brief capsule summary, the tests that were conducted, in the sequence in which they were conducted and the place they were conducted leading up to this day and this week, this month? MSC switch failure found and pick up from there.

CORTRIGHT: I guess I won't try to do that because I don't have all those dates and sequences that sharply in my mind. The key test was here at MSC last Wednesday in which the switches failed.

QUERY: Is there any sensor ...

CORTRIGHT: No. The thermal switch itself is set to open at 80° F plus or minus 10°.

QUERY: Yeah ... thermal switches, is there any idea ... it's two dimensional.

CORTRIGHT: I'm not prepared to discuss the details of that. Now I can guarantee you that there will be thought given to need for such a measurement. I'm not sure if it's needed.

QUERY: Plus or minus 80 degrees - plus or minus how much you can handle ...

QUERY: How did you decide that the insulation was in bad shape or not? I would ...

CORTRIGHT: Just happened to have. (Laughter.)

CORTRIGHT: I intended to bring along and show the original condition so you could imagine that. This is a piece of wire that was baked for 1 hour at 752° F; the insulation is cracked and opened up at various positions on the wire. That represents 1 degree of insulation damage. Subsequent movement of shaking and thermal stresses might have caused pieces to flake off. Now at a little bit higher temperature, 860° F, you can see the insulation is largely gone. That was after 1/2 hour. Now we know that we were quite sure that some portions of the heater tube reached 1000°, probably most of it didn't but it could have been local damage perhaps as bad as this.

QUERY: You'd call that thing cooked, wouldn't you?

QUERY: Several hours, at the Cape at 1000° and this burned off in a half hour; how did he even get airborne?

CORTRIGHT: That's good question and I just don't know the answer to that question. We only have a few measurements in our tests so far that give temperatures on that heater. One of them went as high as I mentioned (1000° F) and it was

very close to the actual heater element. The temperature dropped off fairly rapidly away from that element, I've been led to believe. And therefore, the wires may not have approached these temperatures on most of their length. All we have established really is that the potential was there to destroy the insulation on the wires at least locally.

QUERY: How close is this fan wire adjacent ...

CORTRIGHT: The lower fan motor wires run through the heaters through a small conduit.

QUERY: What's the material of this conduit?

CORTRIGHT: Inconel. I think I'm going to have to limit you to about one more question. Then I have to get back to the meeting.

QUERY: Can you even ball-park roughly how this 65 degree — did you say the voltage it was supposed to be in the switches was two times as high, three times as high, four times as high?

CORTRIGHT: No. I'd rather not. I have an approximate number, but we're checking that today.

QUERY: Could you even just give us a rough thing like it was quite a bit higher?

CORTRIGHT: Was larger.

QUERY: Was it quite a bit larger?

CORTRIGHT: It was large enough, I think, to weld them.

QUERY: What was the material that ... checked?

CORTRIGHT: ... (Laughter.)

STATUS REPORTS OF THE APOLLO 13 REVIEW BOARD

STATUS REPORTS OF THE APOLLO 13 REVIEW BOARD

Status Report No. 1

April 21, 1970

The first meeting of the Apollo 13 Review Board was convened by Chairman Edgar M. Cortright at 8 p.m., c.s.t., April 21, at the Manned Spacecraft Center, Houston, Texas. The Board adjourned at 10 p.m. Present for the first meeting, in addition to the Chairman, were Board Members Neil Armstrong, John F. Clark, Milton Klein, W. R. Hedrick, and Charles W. Mathews. Cortright said the other Members of the Board, which was appointed by NASA Administrator Thomas O. Paine yesterday, intended to join the Board in Houston today. The Members unable to attend last night's preliminary meeting were Dr. H. M. Mark, Robert F. Allnutt, and Vincent L. Johnson.

The Board immediately set itself a work routine which will begin with a 7 a.m. breakfast and end at 9 p.m.

In addition to its own planning meetings and fact-finding sessions, Chairman Cortright allocated an important part of each day to coordinate reviews with the Manned Spacecraft Center's Apollo 13 Investigation Team. Cortright said the Board intended to rely heavily on the data-gathering and analytical capabilities of the Apollo Program Office Team, while at the same time insuring that the Review Board had within its own organization the competence and depth to make a completely independent assessment of any findings or recommendations of the MSC team or any other source.

In this regard, Cortright said the Review Board will wait until later this week when it has had a chance to hear a detailed briefing from the Apollo Program Office Team before it makes final decisions about recruiting additional support or advisory assistance. He said it was too early to know just where and what additional strength will be needed.

Status Report No. 2
April 22, 1970

The Apollo 13 Review Board held its first full day of meetings at the Manned Spacecraft Center today. The Board began the day by familiarizing itself with the status of the investigation of the accident currently underway by the engineers of the Manned Spacecraft Center and its contractors.

Following this the Board took its first detailed look at the suspect area of the liquid oxygen tanks in the service module. E. M. Cortright, Board Chairman, stated that this review included a study of the telemetry records and the anomalies which preceded the destructive event. A detailed discussion of possible causes of failure followed, and the Board members had the opportunity to carefully examine specimens of the type that failed.

Status Report No. 3
April 23, 1970

The Apollo 13 Review Board settled into a routine today, which Board Chairman Edgar M. Cortright expected would carry it at least through next week without a break.

The entire membership of the Board sat in as observers for an early-morning status briefing by Apollo Spacecraft Program engineers on the progress of all investigations and testing currently underway at NASA installations or contractor plants.

Immediately afterward, Cortright called the Board and its supporting experts into session to make the assignments of responsibility as the Board began to tackle in earnest its job of determining what happened to cripple the Apollo 13 service module, why it happened, and to recommend corrective action.

Board Member Neil Armstrong, astronaut, was asked to oversee the area of Mission Events. Mr. Frank Smith, Assistant Administrator, University Affairs, NASA Headquarters, was named chairman of a panel of supporting experts. Board Member John Clark, Director of the NASA Goddard Space Flight Center, was given responsibility for the area of manufacturing and test, and Mr. C. B. Schurmeier of the Jet Propulsion Laboratory was named chairman of the supporting panel. Board Member Vincent L. Johnson, NASA Headquarters, was given responsibility for the area of design, and Mr. S. C. Himmel, Assistant Director for Rockets and Vehicles, Lewis Research Center, will chair the supporting panel. A study of project management aspects pertinent to the Apollo 13 incident will be under the direction of Board Member Milton Klein, Manager of the AEC-NASA Space Nuclear Propulsion Office, and his supporting panel will be headed by Mr. Edward Kilgore of the NASA Langley Research Center. Cortright requested the responsible Board Members and their panel leaders to determine quickly what kind of additional help they will need to carry out their assignments and to submit their recommendations for his approval.

Another of the Board Members, Brigadier General Walter R. Hedrick, Jr., USAF, was given a special assignment to facilitate integration of the various panels' activities.

Dr. Hans Mark, a Member of the Review Board and Director of the NASA Ames Research Center, was given responsibility for special testing and analyses and for identifying consultants if needed.

Mr. Charles Mathews, NASA Headquarters, was asked to supervise liaison between the work of the Review Board and the investigations being carried on by the Apollo Program Office.

Board Member Robert Allnutt, a special assistant to the NASA Administrator, was put in charge of documenting the Board's plans and procedures, and planning the form of the Board's official report.

A fourth official observer was added to the Board today at the direction of NASA Administrator Thomas O. Paine. He is James E. Wilson, technical consultant to the House Committee on Science and Astronautics. Cortright said Wilson, like the other official observers, will sit in on all Board activities.

Status Report No. 4
April 24, 1970

Members of the Apollo 13 Review Board and a number of the Board's supporting experts will make a 1-day field trip to the North American Rockwell plant at Downey, California, tomorrow.

Board Chairman Edgar Cortright said the purpose of the trip will be to inspect available hardware with particular emphasis on the equipment in bay 4 of the service module; to inspect and review any tests which are being conducted as a result of the Apollo 13 flight; and to give the Board Members a complete history of the oxygen system which flew on the Apollo 13 spacecraft. North American Rockwell is the prime contractor for both the Apollo command and service modules.

Review Board Members, in addition to the Chairman, who will make the trip are: Dr. John Clark, Dr. Hans Mark, Mr. Vincent Johnson, Brigadier General Walter R. Hedrick, Jr. (USAF), Mr. Milton Klein, and Mr. Neil Armstrong.

Panel Chairmen making the trip will include: Mr. H. M. Schurmeier, Mr. Frank Smith, and Mr. S. C. Himmel. Mr. Charles Mathews, who is responsible for liaison between the Review Board and the Apollo Program, will make the trip, as will a number of other supporting specialists and staff members.

The Board plans to leave Houston via Air Force jet at 8 a.m. Sunday morning and return to Houston late the same day. The panel will be at the North American Rockwell plant approximately 7 hours.

Status Report No. 5
April 27, 1970

Apollo 13 Review Board panel chairman Harris M. Schurmeier will accompany Apollo project engineers to the plant of the Beech Aircraft Corporation in Boulder, Colorado, on Tuesday to witness the assembly of an Apollo service module oxygen tank.

Beech builds the tank as a subcontractor to North American Rockwell. Schurmeier said the primary purpose of his visit to Beech will be to follow in detail the normal assembly procedures practiced during the insertion of components inside the service module tank. Several Review Board specialists and Apollo project engineers will make the trip also. Schurmeier, of NASA's Jet Propulsion Laboratory, is chairman of a panel of specialists which is assisting the Review Board in the area of manufacturing and test procedures.

Other Board and panel members broke up into working groups today to continue their review of the available data concerning the destructive incident which made it necessary to abort Apollo 13's mission to the Moon.

Status Report No. 6
April 28, 1970

The Apollo 13 Review Board examined carefully processed photographs of the damaged service module today but found the pictures inconclusive.

"It is our opinion that the photographs, at their present stage of processing and analysis, do not establish the condition of the number two oxygen tank or even its presence," said Board Chairman Edgar M. Cortright.

The photographs were taken by the Apollo 13 astronauts after their command module had separated from the service module just before reentry. The pictures, from 70-millimeter still photographs and frames of 16-millimeter motion picture footage, show the interior of the service module's bay 4 which contained fuel cells and oxygen and hydrogen tanks. The Board had hoped that the photographs would help establish the condition of the number 2 oxygen tank, prime suspect in the Apollo 13 equipment failure. Efforts to bring out further detail in the photography with sophisticated enhancement techniques continues here at the Manned Spacecraft Center and elsewhere around the country. However, the products of this work will not be available to the Board until sometime next week. Members of the Board and Apollo Program engineers have said from the beginning that the most valuable clues to what happened in the service module will come from the telemetered data received from the spacecraft, rather than from photography.

Chairman Cortright said that the Board and the MSC team investigating the accident will make interim progress reports to NASA Deputy Administrator George Low on Friday morning at the Manned Spacecraft Center. In the meantime, study of data by the various investigative panels continues.

Status Report No. 7
April 29, 1970

The Management Panel of the Apollo 13 Review Board scheduled inspection trips to the North American Rockwell plant at Downey, California, today and to the Beech Aircraft Corp. plant at Boulder, Colorado, tomorrow.

Panel Chairman Edward Kilgore, of the NASA Langley Research Center, heads the Board's team of specialists. The Panel is charged with a study of project management aspects pertinent to the Apollo 13 failure.

Status Report No. 8
April 29, 1970

Dr. Charles D. Harrington, Chairman of the Aerospace Safety Advisory Panel, a statutory body created by Congress after the Apollo 1 fire, arrived today for 2 days of briefing by the Apollo 13 Review Board and Apollo Program engineers.

Dr. Harrington was accompanied by Mr. Carl Praktish, the Panel's executive secretary, and Mr. Emerson Harris, the Panel's deputy executive secretary. Dr. Harrington is an official observer of the Review Board. In addition, the Safety Panel has been asked by NASA Administrator Thomas O. Paine to review the procedures and findings of the Apollo 13 Board, and the Board is required to keep the Safety Panel informed of its work and progress.

Tonight (Wednesday) several members of the Review Board will experience, with fellow Board Member Neil Armstrong as a guide, what it was like in the Apollo 13 command module at the moment when the crisis was discovered. Armstrong said the command module training simulator at the Manned Spacecraft Center will be used to try to give the Board Members and some of the panelists a better appreciation of the failure from the crewmen's point of view.

"The Board Members will see what indications of the incident were available in the spacecraft and, particularly, how the positions of the various crew members would affect their ability to interpret what was taking place," Armstrong said.

"It is just one more way to reconstruct the incident," he added.

Status Report No. 9
April 30, 1970

Members of the Apollo 13 Review Board and its Panels spent most of today summarizing findings to date for an interim review of progress for NASA Deputy Administrator George Low. Low will get a 3-hour combined briefing from the Board and project officers.

Status Report No. 10
May 5, 1970

The Apollo 13 Review Board and the MSC Apollo 13 Investigation Team will brief the Aerospace Safety Advisory Panel all day tomorrow.

Dr. Charles Harrington, Chairman of the Panel, and seven panel and staff members will be given a complete review of the Apollo 13 failure and the progress of the investigations so far, and will meet with individual members of the Board. The Harrington Panel also will inspect the service module oxygen tank and associated equipment and will participate in a simulator demonstration. The Aerospace Safety Advisory Panel is a statutory body created by Congress after the Apollo 1 fire. NASA Administrator Thomas O. Paine has asked the Safety Panel to review all findings and procedures of the Review Board.

Members of the Board's Project Management Panel were at the Kennedy Space Center in Florida this week as part of a continuing study of all aspects of government and contractor management pertinent to the Apollo 13 failure. The Board worked through the past weekend and on Monday taking progress reports from its four Panels - Mission Events, Design, Manufacturing and Test, and Project Management. The Board has been conferring, too, with the Apollo Program Team to determine the scope and variety of tests to be conducted at NASA installations or at contractor plants to further pinpoint the cause of the Apollo 13 failure and, eventually, to validate proposed design changes.

Robert Wells, an electrical engineer from the NASA Langley Research Center, joined the Design Panel this week.

Status Report No. 11
May 7, 1970

The Apollo 13 Review Board will take its first break this weekend since it went to work on April 21. Chairman Edgar M. Cortright said he would adjourn the Board on Friday and not reconvene until Tuesday, May 12. Most of the Board and Panel Members are from out of town and have not had a chance to get home since the Board was convened.

After the Board reconvenes next Tuesday, Cortright plans to stay in session until the end of the month in an effort to deliver a finished report on the Apollo 13 failure to NASA Administrator Thomas O. Paine by June 1. The day-to-day work of the Board and its Panels continues to be a detailed review of all available information on the Apollo 13 accident, testing of principal hypotheses, and preliminary work on individual segments of the report.

Status Report No. 12
May 13, 1970

Apollo 13 Review Board Chairman Edgar Cortright will be in Los Angeles tomorrow on business for the Langley Research Center, where he is Director. Board member Vincent L. Johnson, Deputy Associate Administrator for Engineering in NASA's Office of Space Science and Applications, is acting chairman in Cortright's absence.

In the meantime, our Board Members and Panel Chairmen worked to have a final report ready for NASA Administrator Thomas O. Paine by June 1. Today was spent interviewing persons with special knowledge of the Apollo 13 mission or Apollo spacecraft systems and in refining draft sections of the Board's report.

Status Report No. 13
May 25, 1970

The Apollo 13 Review Board expects to make its final report on June 8 instead of June 1, Chairman Edgar M. Cortright said today.

The 1-week delay in the previously announced schedule is to allow time for completion of special tests currently under way at NASA Centers and contractor plants, Cortright said. The Chairman said he informed NASA Administrator Thomas O. Paine of the need for the delay this morning.

Cortright said that in view of the new schedule, the Board will recess Wednesday evening and reconvene the following Monday morning. He said he plans to deliver the final report to Paine and Deputy Administrator George Low in Washington on Monday, June 8.

Status Report No. 14
May 27, 1970

A special detanking procedure which was applied to the no. 2 oxygen tank of the Apollo 13 service module before launch "probably resulted in major damage to the wiring insulation in the tank," the Chairman of the Apollo 13 Review Board said today.

Chairman Edgar M. Cortright said the probability that significant damage occurred to the insulation during the detanking procedures developed during tests conducted at the Manned Spacecraft Center in Houston, Texas, over the last few days.

The detanking, a partial draining of the oxygen in the tank, occurred during preflight preparations on the pad at the Kennedy Space Center before the launch of Apollo 13.

Tests will continue over the next few days in an effort to substantiate the findings so far, Cortright said, and the Review Board will hear the results of this work when it reconvenes at the Manned Spacecraft Center on Monday, June 1.

In discussing the detanking tests, Cortright said it now appears that two thermal switches, designed to protect the heaters in the tank from overheating, may have failed. In such an event, other tests have shown that the heater tube in the tank could have reached temperatures of about 1000° F and that such temperatures would seriously damage the insulation around the heater wires, he said.

Cortright said such insulation damage could have resulted in the arcing short circuits which are believed to have initiated the combustion of insulation inside the tank during the flight. The burning, in turn, raised the pressure of the supercritical oxygen and caused the tank to rupture.

Another area of testing which the Board will hear about on Monday seeks to determine the manner in which the tank finally failed and what mechanism was needed to cause the outer panel of the service module to blow off.

Cortright said the Board continues to expect to deliver its final report to NASA Administrator Thomas O. Paine and Deputy Administrator George M. Low on Monday, June 8, 1970.

Status Report No. 15
June 5, 1970

Apollo 13 Review Board Chairman Edgar M. Cortright said today that he plans to send the final draft of the Board's report to the printer about the middle of next week and deliver the full report to Dr. Thomas O. Paine, NASA Administrator, in Washington on Monday, June 15, 1970.

This page left blank intentionally.

NASA — MSC

H-62